

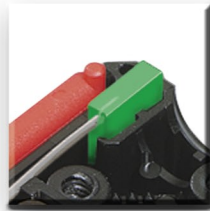

swing-out puller tool



optionally with LED

or without LED

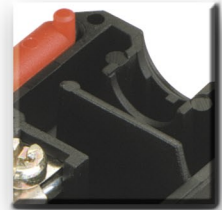

with maze-like strain relief



or with screwed strain relief

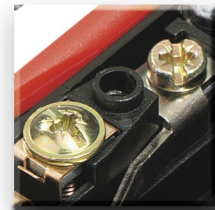
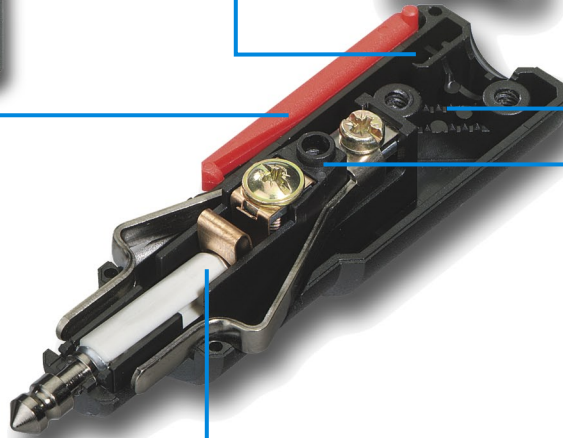

screw terminal for cables up to 2,5 mm<sup>2</sup>

available as safety universal plug fused up to 16 A

or as unfused universal plug

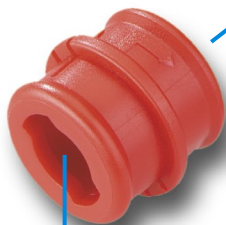

adaptor can be firmly positioned by a bayonet catch hence offering an excellent contact in the cigarette lighter socket



Maahantuoja:



Oy Kaha Ab  
 Ansatie 2  
 01740 Vantaa

www.kaha.fi  
 teollisuus@kaha.fi  
 puh 09 615 6800

Myynti  
 puh 09 615 68300  
 fax 09 615 68301



### Universal Plug with screwed strain relief

8 and 16 A, 12-24 V, fitting for cigarette lighter and standard sockets, screw terminals for cables up to 2.5 mm<sup>2</sup>, adaptor that can be firmly positioned by a bayonet catch, swing-out puller tool.

	BP	SP
	SU = 500	SU = 60
<b>8 A</b>	67711000	67721000
<b>16 A TÜV certified</b>	67711010	67721010



### Universal Plug with maze-like strain relief

8 and 16 A, 12-24 V, fitting for cigarette lighter and standard sockets, screw terminals for cables up to 2.5 mm<sup>2</sup>, adaptor that can be firmly positioned by a bayonet catch, swing-out puller tool.

	BP	SP
	SU = 500	SU = 60
<b>8 A</b>	67713000	67723000
<b>16 A TÜV certified</b>	67713010	67723010



### Safety Universal Plug with screwed strain relief

With integrated, interchangeable fuse from 1-16 A, 12-24 V, fitting for cigarette lighter and standard sockets, screw terminals for cables up to 2.5 mm<sup>2</sup>, adaptor that can be firmly positioned by a bayonet catch, swing-out puller tool.

fused	BP	SP
	SU = 500	SU = 60
<b>1 A</b>	67712001	67722001
<b>2 A</b>	67712002	67722002
<b>5 A</b>	67712005	67722005
<b>8 A</b>	67712000	67722000
<b>16 A TÜV certified</b>	67712010	67722010



### Safety Universal Plug with maze-like strain relief

With integrated, interchangeable fuse from 1-16 A, 12-24 V, fitting for cigarette lighter and standard sockets, screw terminals for cables up to 2.5 mm<sup>2</sup>, adaptor that can be firmly positioned by a bayonet catch, swing-out puller tool.

fused	BP	SP
	SU = 500	SU = 60
<b>1 A</b>	67714001	67724001
<b>2 A</b>	67714002	67724002
<b>5 A</b>	67714005	67724005
<b>8 A</b>	67714000	67724000
<b>16 A TÜV certified</b>	67714010	67724010

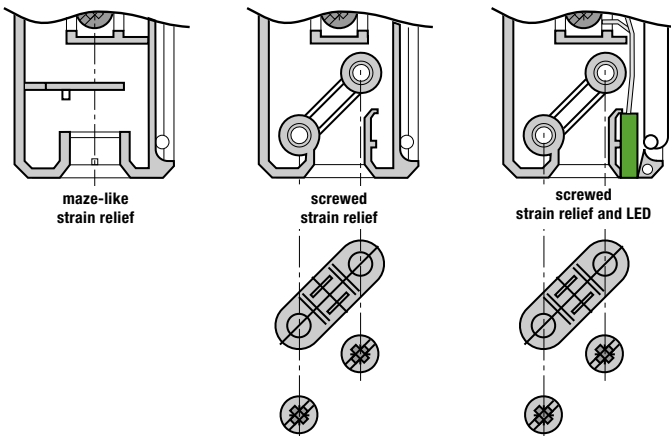



**Universal Plug with screwed strain relief and LED**

8 and 16 A, 12-24 V, fitting for cigarette lighter and standard sockets, screw terminals for cables up to 2.5 mm<sup>2</sup>, adaptor that can be firmly positioned by a bayonet catch, swing-out puller tool.

	BP	SP
	SU = 500	SU = 60
<b>8 A</b>	67711100	67721100
<b>16 A TÜV certified</b>	67711110	67721110



**Buckling Protective Sleeve**

for universal plug and safety universal plug, standard internal Ø 4 mm.

BP
80106000

... great contact  
and easy  
to connect!



**Safety Universal Plug with screwed strain relief and LED**

With integrated, interchangeable fuse from 1-16 A, 12-24 V, fitting for cigarette lighter and standard sockets, screw terminals for cables up to 2.5 mm<sup>2</sup>, adaptor that can be firmly positioned by a bayonet catch, swing-out puller tool.

	BP	SP
<b>fused</b>	SU = 500	SU = 60
<b>1 A</b>	67712101	67722101
<b>2 A</b>	67712102	67722102
<b>5 A</b>	67712105	67722105
<b>8 A</b>	67712100	67722100
<b>16 A TÜV certified</b>	67712110	67722110



**Power Plug 20 A max. / 12-24 V**

Assembled with cable 2 x 2.5 mm<sup>2</sup>, length 1.2 m. Fitting for cigarette lighter and power sockets. For connecting coffee makers, kettles, heaters etc.

Special versions on request.

	BP	SP
	SU = 100	SU = 60
<b>max. 20 A</b>	67101284	67101285



**Universal Angular Plug**

With operational check by diode. 7.5 A / 12-24 V, adaptor that can be firmly positioned by a bayonet catch, screwed strain relief, cable cross-section max. 1.5 mm<sup>2</sup>, Ø 8 mm, fitting for cigarette lighter and standard sockets according to DIN EN ISO 4165.

	BP	SP
	SU = 100	SU = 20
<b>7,5 A</b>	57730000	57730001



### Bendable Universal Plug

Bendable up to 180°, with screw terminals, with or without strain relief, adaptor that can be firmly positioned by a bayonet catch, 12-24 V, fitting for cigarette lighter and standard sockets.

	BP	SP
	SU = 100	SU = 60
8 A with screwed strain relief	67741000	67741500
8 A without strain relief	67741100	–

### Bendable Safety Universal Plug

Bendable up to 180°, with screw terminals, with or without strain relief, adaptor that can be firmly positioned by a bayonet catch, 12-24 V, fitting for cigarette lighter and standard sockets. With integrated, interchangeable fuse from 1-8 A / 12-24 V.

fused	BP	SP
	SU = 100	SU = 60
1 A with screwed strain relief	67742001	–
2 A with screwed strain relief	67742002	–
8 A with screwed strain relief	67742000	67742500
1 A without strain relief	67742101	–
2 A without strain relief	67742102	–
8 A without strain relief	67742100	–



### Example of use

Offering sufficient space for your electronics.

dimensions for pcb:

- with screwed strain relief = 28.5 x 26.5 x 1.5 mm
- strain relief by prommet = 35.5 x 26.5 x 1.5 mm



### Bendable Universal Plug with switch

8 A / 12-24 V, with single-pole circuit breaker 8 A, rocker switch imprinted with 0-I. The plug is bendable up to 180°, with screw terminals, adaptor that can be firmly positioned by a bayonet catch, fitting for cigarette lighter and standard sockets.

	BP	SP
	SU = 100	SU = 60
8 A	67746000	67746500

### Bendable Safety Universal Plug with switch

8 A / 12-24 V, with single-pole circuit breaker 8 A, rocker switch imprinted with 0-I. The plug is bendable up to 180°, with screw terminals, adaptor that can be firmly positioned by a bayonet catch. With integrated, interchangeable fuse 8 A, fitting for cigarette lighter and standard sockets.

fused	BP	SP
	SU = 100	SU = 60
8 A	67747000	67747500



### Bendable Universal Plug with switch

8 A / 12-24 V, with single-pole circuit breaker 8 A, rocker switch imprinted with 0-I, assembled with cable 2 x 0.75 mm<sup>2</sup>, length 2.0 m. The plug is bendable up to 180°, with screw terminals, adaptor that can be firmly positioned by a bayonet catch, fitting for cigarette lighter and standard sockets.

	BP	SP
	SU = 100	SU = 60
8 A	67745000	67745500

### Bendable Safety Universal Plug with switch

8 A / 12-24 V, with single-pole circuit breaker 8 A, rocker switch imprinted with 0-I, assembled with cable 2 x 0.75 mm<sup>2</sup>, length 2.0 m. The plug is bendable up to 180°, with screw terminals, adaptor that can be firmly positioned by a bayonet catch. With integrated, interchangeable fuse 8 A, fitting for cigarette lighter and standard sockets.

fused	BP	SP
	SU = 100	SU = 60
8 A	67748000	67748500



### Standard Plug 8 A

With soldering contacts and maze-like strain relief, for connecting any type of 8 A accessory, 12-24 V, fitting for all standard sockets according to DIN EN ISO 4165.

	BP	SP
	SU = 500	SU = 60
<b>8 A</b>	67751000	67751500



### Standard Plug 15 A

With screw terminals, for connecting any type of 15 A accessory, 12-24 V, easy to assemble, optimal contact, fitting for all standard sockets according to DIN EN ISO 4165.

	BP	BP
	SU = 500	SU = 60
<b>15 A</b>	53005000	53005001

... fits well  
great connections!



### Standard Plug 12 A

With screw terminals and strain relief. For connecting any type of 12 A accessory, 12-24 V, fitting for all standard sockets according to DIN EN ISO 4165.

	BP	SP
	SU = 500	SU = 60
<b>12 A</b>	58078300	58078301



### DIN-Socket-Adaptor 16 A

12-24 V. Adaptor for use of devices with cigarette lighter plug in standard sockets. Straight type, one side internal Ø 21mm fitting for cigarette lighter plugs, other side fitting for standard sockets according to DIN EN ISO 4165.

	BP	SP
	SU = 200	SU = 60
<b>16 A</b>	67872900	67882900





### DIN-Standard Built-In Socket

With 6.3 mm flat terminals. Fastening by hexagon nut, fitting for standard and universal plug, 16 A / 12-24 V max., TÜV certified and monitored, with contacts according to DIN EN ISO 4165. Port for installation: 18 mm.

	BP	SP
	SU = 500	SU = 60
<b>16 A</b>	57607000	57607001



### DIN-Standard Built-In Socket with Mounting Plate

With 6.3 mm flat terminals. Fastening by hexagon nut, fitting for standard and universal plug, 16 A / 12-24 V max., TÜV certified and monitored, with contacts according to DIN EN ISO 4165. Port for installation: 18 mm.

	BP	SP
	SU = 500	SU = 60
<b>with protective cap</b>	57607032	57607033
<b>without protective cap</b>	57607030	57607031



### DIN-Standard Built-In Socket with Protective Cap

Dust and splash-proof version. With 6.3 mm flat terminals. Fastening by hexagon nut, fitting for standard and universal plug, 16 A / 12-24 V max., TÜV certified and monitored, with contacts according to DIN EN ISO 4165. Port for installation: 18 mm.

	BP	SP
	SU = 500	SU = 60
<b>16 A</b>	57607002	57607003



### Motorcycle Socket with snap-on lid

12 V / 10 A, for connecting battery chargers, navigation systems, PDA's and other devices. Fitting for universal and safety universal plug, weather and splash-proof, assembled with approx. 50 cm cable, internal Ø 21 mm.

	BP	SP
	SU = 50	SU = 20
<b>12 V / 10 A</b>	57607050	57607550



### DIN-Standard Built-In Socket, Metal, with Protective Cap

With 6.3 mm flat terminals, fitting for standard and universal plug, 16 A / 12-24 V max. Port for installation: 18 mm.

	BP	SP
	SU = 100	SU = 60
<b>16 A</b>	53114320	53114321



### DIN Built-In Socket, waterproof

12-24 V, waterproof to IP 67, cables are waterproof encapsulated, with screw cap, 16 A, contacts according to DIN EN ISO 4165, ready-made 300 mm cable. Fastening by hexagon nut. Port for installation: 18.4 mm. Temperature resistant: -40°C to 105°C.

	BP	SP
	SU = 50	SU = 20
<b>16 A</b>	52005000	52005001



### Surface Mounted Socket

With 6.3 mm flat terminals, fitting for standard and universal plug, 16 A / 12-24 V max., TÜV certified and monitored, with contacts according to DIN EN ISO 4165.

	BP	SP
	SU = 100	SU = 60
<b>16 A</b>	57608000	57608001



### Surface Mounted Socket with Protective Cap

Dust-proof and splash-proof version. With 6.3 mm flat terminals, fitting for standard and universal plug, 16 A / 12-24 V max., TÜV certified and monitored, with contacts according to DIN EN ISO 4165.

	BP	SP
	SU = 100	SU = 60
<b>16 A</b>	57608002	57608003



### Triple Built-In Socket

Three standard sockets, 12-24 V. Connection with 6.3 mm flat terminals. Overall load up of all three Sockets: 16 A, with contacts according to DIN EN ISO 4165.

	BP	SP
	SU = 100	SU = 60
<b>16 A</b>	57612002	57612003



### Power Socket Connector

12-24 V, 20 A max. based on a cable cross section of 2.5 mm<sup>2</sup>, 16 A based on a cable cross section of 1.5 mm<sup>2</sup>, for constructing overhung connection. Internal Ø 21 mm, with 6.3 mm flat terminals, fitting for universal plug.

	BP	SP
	SU = 100	SU = 60
<b>12-24 V / max. 20 A</b> , with base plate	67604500	67614500



### Surface Mounted Power Socket

12-24 V. Current-carrying capacity: 20 A based on a cable cross section of 2.5 mm<sup>2</sup>, 16 A based on a cable cross section of 1.5 mm<sup>2</sup>. Internal Ø 21 mm, with 6.3 mm flat terminals, fitting for universal plug.

	BP	SP
	SU = 100	SU = 60
<b>12-24 V / max. 20 A</b>	67604000	67614000



**NEW**  
with **USB**

### USB Surface Mounted Socket

12 V DC / 5 V DC 1000 mA, with intergrated power voltage converter, for charging and operating sat navs, mobile phones, smart phones, PDAs, digital cameras and devices that are suitable for charging by 5 Volt USB.

	BP	SP
	SU = 100	SU = 60
<b>12 V</b>	67313000	67313500



### Triple Surface Mounted Power Socket

12-24 V, 20 A max. based on a cable cross section of 2.5 mm<sup>2</sup>, 16 A based on a cable cross section of 1.5 mm<sup>2</sup>. Internal Ø 21 mm. Mounting screws included

	BP	SP
	SU = 100	SU = 20
<b>12-24 V</b>	67601000	67611000



**NEW**  
with **USB**

### Triple Surface Mounted Socket with USB Socket

Two power sockets max. 20 A based on a cable cross section of 2.5 mm<sup>2</sup>, 16 A based on a cable cross section of 1.5 mm<sup>2</sup> and one USB Socket 12 V DC / 5 V DC 1000 mA, for charging and operating sat navs, mobile phones, smart phones, PDAs, digital cameras and devices that are suitable for charging by 5 Volt USB.

	BP	SP
	SU = 100	SU = 20
<b>12 V</b>	67314000	67314500



### Triple Power Socket

With universal plug 16 A, connection possible to all cigarette lighter sockets and DIN standard sockets, 12-24 V, 16 A max. with three sockets. Internal Ø 21 mm. Cable: 2 x 1.5 mm<sup>2</sup> flat cable. Length: 2.0 m

	BP	SP
	SU = 50	SU = 20
<b>12-24 V / 16 A</b>	67601500	67611500



**NEW**  
with **USB**

### Triple Power Socket with USB Socket

Two power sockets and one USB socket 12 V DC / 5 V DC 1000 mA, for charging and operating sat navs, mobile phones, smart phones, PDAs, digital cameras and devices that are suitable for charging by 5 Volt USB.

	BP	SP
	SU = 50	SU = 20
<b>12 V / 16 A</b>	67315000	67315500



### Power Socket with clamp sleeve

Designed to operate electrical devices in cars, boats and caravans. Current-carrying capacity: 20 A based on a cable cross section of 2.5 mm<sup>2</sup>, 16 A based on a cable cross section of 1.5 mm<sup>2</sup>. Internal Ø 21mm, port for installation 27.8 mm. Fastening by clamp sleeve.

	BP	SP
<b>illuminated</b>	SU = 160	SU = 60
<b>12 V, clamp sleeve clear</b>	68040740	68140740
<b>12 V, clamp sleeve red</b>	68040750	68140750
<b>12 V, clamp sleeve green</b>	68040760	68140760
<b>24 V, clamp sleeve clear</b>	68040770	68140770
<b>24 V, clamp sleeve red</b>	68040780	68140780
<b>24 V, clamp sleeve green</b>	68040790	68140790

	BP	SP
<b>without illumination</b>	SU = 160	SU = 60
<b>12-24 V, clamp sleeve green</b>	68040860	68140860

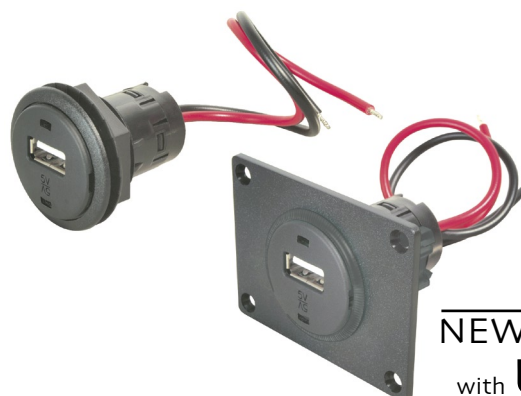

**NEW**  
with **USB**

### USB Built-In Socket with and without Mounting Plate

12 V DC / 5 V DC 1000 mA, with intergrated power voltage converter, for charging and operating sat navs, mobile phones, smart phones, PDAs, digital cameras and devices that are suitable for charging by 5 Volt USB. Fastening by plastic screw nut, installation dimensions Ø 27,8 mm

	BP	SP
	SU = 100	SU = 60
<b>12 V, without mounting plate</b>	67311000	67311500
<b>12 V, with mounting plate</b>	67312000	67312500





### Power Socket with screw thread

Designed to operate electrical devices in cars, boats and caravans. Current-carrying capacity: 20 A based on a cable cross section of 2.5 mm<sup>2</sup>, 16 A based on a cable cross section of 1.5 mm<sup>2</sup>. Internal Ø 21 mm, port for installation 27.8 mm. Fastening by hexagon nut.

	BP	SP
	SU = 160	SU = 60
12-24 V, screw thread black	68040800	68140800
12-24 V, screw thread red	68040810	68140810
12-24 V, screw thread green	68040820	68140820



### Power socket with Mounting Plate

12-24 V with clamp sleeve, without illumination, with mounting plate for front installation in e.g. thick-walled wood panels. Designed to operate electrical devices in cars, boats and mobile homes. Current-carrying capacity: 20 A based on a cable cross section of 2.5 mm<sup>2</sup>, 16 A based on a cable cross section of 1.5 mm<sup>2</sup>. Internal Ø 21 mm, port for installation 32 mm. Fastening by clamp sleeve snapped into the mounting plate: length: 60 mm, width: 45 mm, height: 2.2 mm. Mounting screws included.

	BP	SP
	SU = 160	SU = 60
12-24 V, clamp sleeve green, with mounting plate	68041000	68141000

... mature technology  
for original equipment!



### Cigarette Lighter with screw thread

12 and 24 V. With 6.3 mm flat terminals. Port for installation 27.8 mm. Fastening by hexagon nut. All versions also available for 24 V.

	BP	SP
	SU = 160	SU = 60
12 V, small knob, screw thread black	68031170	68131170
12 V, small knob, screw thread red	68031180	68131180
12 V, small knob, screw thread green	68031190	68131190
12 V, large knob, screw thread black	68031200	68131200
12 V, large knob, screw thread red	68031210	68131210
12 V, large knob, screw thread green	68031220	68131220



### Cigarette Lighter with clamp sleeve, illuminated

12 and 24 V. With 6.3 mm flat terminals. Port for installation 27.8 mm. Fastening by clamp sleeve. All versions also available for 24 V.

	BP	SP
	SU = 160	SU = 60
12 V, small knob, clamp sleeve clear	68031050	68131050
12 V, small knob, clamp sleeve red	68031060	68131060
12 V, small knob, clamp sleeve green	68031070	68131070
12 V, large knob, clamp sleeve clear	68031080	68131080
12 V, large knob, clamp sleeve red	68031090	68131090
12 V, large knob, clamp sleeve green	68031100	68131100



### Extension Cable

2 x 0.75 mm<sup>2</sup> helix cable. Length 0.6 m to 3.0 m.  
With 8 A safety universal plug (integrated fuse) and socket connector (internal Ø 21 mm), 12-24 V.

	BP	SP
	SU = 100	SU = 20
<b>8 A</b>	67818100	67828100



### Extension Cable

2 x 0.75 mm<sup>2</sup> flat cable. Length 4.0 m.  
With 8 A safety universal plug (integrated fuse) and socket connector (internal Ø 21 mm), 12-24 V.

	BP	SP
	SU = 100	SU = 20
<b>8 A</b>	67814100	67824100



### Extension Cable

2 x 0.75 mm<sup>2</sup> flat cable. Length 4.0 m. With 8 A safety universal plug (integrated fuse) and fracture-proof socket connector with contacts according to DIN EN ISO 4165, fitting for standard and universal plug.

	BP	SP
	SU = 100	SU = 20
<b>8 A</b>	67814000	67824000



### Connector

8 A, (internal Ø 21 mm), with 1.0 m feeder and crocodile clips.

	BP	SP
	SU = 150	SU = 60
<b>8 A</b>	67874000	67884000



### Helix Cable

2 x 0.75 mm<sup>2</sup> helix cable. Length 0.6 m to 3.0 m. With 8 A safety universal plug (integrated fuse) or universal plug. Standard version 8 A. Special versions on request.

	BP	SP
	SU = 100	SU = 20
with safety universal plug 8 A	67838000	67848000
with universal plug 8 A	67837000	67847000



### Flat Cable

2 x 0.75 mm<sup>2</sup> flat cable. Length 4.0 m. With 8 A safety universal plug (integrated fuse) or universal plug. Standard version 8 A. Special versions on request.

	BP	SP
	VSU = 100	SU = 60
with safety universal plug 8 A	67834000	67844000
with universal plug 8 A	67833000	67843000



**Flat Cable**

2 x 0.75 mm<sup>2</sup> flat cable. Length 1.8 m. With socket connector (internal Ø 21 mm), 12-24 V, 8 A max.

	BP	SP
	SU = 150	SU = 20
<b>8 A</b>	67877000	67887000



**Helix Cable**

2 x 0.75 mm<sup>2</sup> helix cable. Length 0.6 m to 3.0 m. With socket connector (internal Ø 21 mm), 12-24 V, 8 A max

	BP	SP
	SU = 100	SU = 20
<b>8 A</b>	67878000	67888000



**Adaptor**

With standard plug and socket connector (internal Ø 21 mm), 12-24 V, 8 A max., 2 x 0.75 mm<sup>2</sup> flat cable, length 0.25 m.

	BP	SP
	SU = 200	SU = 60
<b>8 A</b>	67872000	67882000



**Adaptor with Power Plug**

With socket connector (internal Ø 12 mm) according to DIN EN ISO 4165, 12-24 V, 16 A max. Flat cable 2 x 1.5 mm<sup>2</sup>, length 0.25 m.

	BP	SP
	SU = 200	SU = 60
<b>16 A</b>	67801000	67801500



**Socket Connector**

To install individual extensions for supplying power to electric accessories and lights, 16 A / 12-24 V max., with contacts according to DIN EN ISO 4165.

	BP	SP
	SU = 100	SU = 60
<b>16 A</b>	57620000	57620001

... manufacturing and trade!



### Twin Socket Connector

With two standard sockets to connect two electric accessories, flexible connection to the board system using the TÜV certified safety universal plug with interchangeable 16 A fuse, with contacts according to DIN EN ISO 4165.

	BP	SP
	SU = 50	SU = 20
16 A	67652000	67662000



### PowerTwin Socket Connector

With universal plug 16 A, permits connection in all cigarette lighters sockets and DIN standard sockets, 12-24 V, max. 16 A with two socket-connectors, internal Ø 21mm. Sturdy design.

	BP	SP
	SU = 60	SU = 20
16 A	67654000	67664000



### Twin Socket Connector

Connection is possible in all sockets for cigarette lighters, two large sockets (internal Ø 21 mm), 12-24 V, 2 x 8 A max. Integrated interchangeable 16 A fuse. 2 x 0.75 mm<sup>2</sup> flat cable, length 0.25 m.

	BP	SP
	SU = 100	SU = 20
16 A	67879000	67889000

... to connect  
with the best contact!



### Appliance Cable 2 A

Safety universal plug 2 A assembled with cable 2 x 0.4 mm<sup>2</sup>, length 2 m and DC connector, angled.

	BP	SP
	SU = 200	SU = 60
DC connector 2.1 x 5.5 mm	67854900	67864900
DC connector 2.5 x 5.5 mm	67854910	67864910



### Appliance Cable 8 A

Safety universal plug 8 A assembled with cable 2 x 0.75 mm<sup>2</sup>, length 2 m and DC connector, straight.

	BP	SP
	SU = 200	SU = 60
DC connector 2.1 x 5.5 mm	67854930	67864930
DC connector 2.5 x 5.5 mm	67854920	67864920





e1 035605



**Charging Cable with Micro USB Plug**

12-24 V, output 5 V, 2000 mA. For charging and operating sat navs, mobile phones, smart phones, PDAs, digital cameras and devices that are suitable for charging by 5 V USB. With high-performance flyback converter and integrated protection against short-circuit, polarity reversal and overload. Fitting for cigarette lighter and standard socket by using an up to 180° bendable universal plug, cable length: appr. 1.80 m.

	BP	SP
	SU = 100	SU = 60
12-24 V	67303000	67303100



e1 035605



**Charging Cable with Multi Plug**

12-24 V, output 5 V, 2000 mA. Including four adapters for charging and using the most popular sat navs, PDAs, digital cameras and other electronic devices. With high-performance flyback converter and integrated protection against short-circuit, polarity reversal and overload. Fitting for cigarette lighter and standard socket by using an up to 180° bendable universal plug, cable length: appr. 1.50 m. Mini-USB Plug, 5.5 x 2.5 mm plug, 4.0 x 1.70 mm plug, 3.5 x 1.35 mm plug

	BP	SP
	SU = 100	SU = 60
12-24 V	67854850	67864850



e1 035605



**Charging Cable with Mini USB Plug**

12-24 V, output 5 V, 2000 mA. For charging and operating sat navs, mobile phones, smart phones, PDAs, digital cameras and devices that are suitable for charging by 5 V USB. With high-performance flyback converter and integrated protection against short-circuit, polarity reversal and overload. Fitting for cigarette lighter and standard socket by using an up to 180° bendable universal plug, cable length: appr. 1.80 m.

	BP	SP
	SU = 100	SU = 60
12-24 V	67854800	67864800



**Digital Timer**

Reliable on and off switching of programmed time sets - for electrical devices like cool-boxes, seat heatings, lamps etc. Board network 12 V DC ± 10%, breaking capacity max. 10 (5) A / 120 W resistive load, 28 storage locations (14 x on / 14 x off), daily and weekly programme.

	BP
	SU = 30
12 V / 8 A	50080000



NEW  
 with **USB**

**USB Extension Cable**

With 2 A safety universal plug, input voltage 12 V battery power, output voltage USB 5 V DC 1000 mA. For charging and operating sat navs, mobile phones, smart phones and devices that are suitable for charging by 5 Volt USB.

	BP	SP
	SU = 100	SU = 60
12 V	68302050	68302150



NEW  
 with **USB**

**USB Charger Connector 5 V with protective cover**

Input voltage 12 V battery power / output voltage USB 5 V DC 1000 mA. For charging and operating sat navs, mobile phones, smart phones and devices that are suitable for charging by 5 Volt USB.

	BP	SP
	SU = 100	SU = 60
12 V	68302010	68302110

rated voltage	12V
operation current	8A
cut-out voltage	11.5 ± 0.2V
cut-in voltage	12.6 ± 0.2V
natural current consumption = ON/OFF	20 / 5 mA



### Battery Control

Protects the battery from excessive discharge caused by electrical appliances such as coolboxes, seat heatings, fans, etc. by automatic cut-out of the power supply. Renewed cut-in with the return of normal voltage conditions. Fitting for cigarette lighter and standard socket, with LED operational check and short circuit protection. 1.0 m feeder with connector (internal Ø 21 mm), bendable and therefore adjustable to various space conditions around the cigarette lighter.

	BP	SP
	SU = 100	SU = 10
<b>12 V / 8 A</b>	67301000	67301100



### k.o.-Gasalarm 12-24 Volt

The protection against attacks with narcotic gases in mobile homes, cars and trucks.

Warning by loud signal, long before the gas effects.

- warns for narcotic gases
- with 1.8 m cable and bendable universal plug with switch for multiple use in 12 V sockets for cigarette lighter and standard built-in sockets
- audible and optical signal
- dimensions 130 x 75 x 40 mm
- wall mounting included

	SP
	SU = 50
<b>12-24 V</b>	52002005

### k.o.-Gasalarm 12-24 Volt with relay 1 A

Option for connection with other devices e.g. additional alarm systems/sirenes/beacons. The protection against attacks with narcotic gases in mobile homes, cars and trucks.

	SP
	SU = 50
<b>12-24 V</b>	52002007



### Dimmer 12 Volt DC and 12/24 Volt DC

Automatic switching between 12 V and 24 V operation. Regulates from 1.5 W up to 140 W 12 V DC and up to 280 W in 24 V DC systems. The dimmer is equipped with a unique output limiter, which maximizes the output to the nominal value for 12 and 24 V lamps and with a constant lighting feature. Short-circuit proof and protected against overloading, overvoltage, overtemperature and faulty connection. Dimensions: 60 x 60 x 35 mm, opening for installation: Ø 46 mm.

	Volt	Watt	SP
			SU = 50
<b>white</b>	12 V	70 W	50021000
<b>brown</b>	12 V	70 W	50021010
<b>black</b>	12 V	70 W	50021020
<b>white</b>	12 / 24 V	max. 140 / 280 W	50022000
<b>brown</b>	12 / 24 V	max. 140 / 280 W	50022010
<b>black</b>	12 / 24 V	max. 140 / 280 W	50022020

Further colours on request.

... electronics  
for your safety!



### k.o.-Gasalarm 230 Volt

The protection against attacks with narcotic gases in houses, flats, etc., warning by loud signal, long before the gas effects.

- warns for narcotic gases
- audible and optical signal
- dimensions 130 x 75 x 40 mm
- wall mounting included
- on/off-intermediate switch

	SP
	SU = 50
<b>230 V</b>	52002008

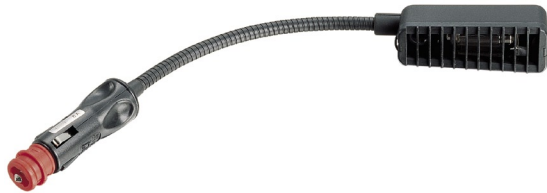

### Reading Light „Pilot Light“

Ready for use without assembly. Light unit with slide switch, antiglare screen, integrated reflector, flexible arm moveable in all directions and safety universal plug. With integrated 8 A fuse to protect the board system, according to DIN EN ISO 4165. Connection to cigarette lighter and standard sockets without any problems.

	BP	SP
	SU = 100	SU = 60
<b>12 V / 10 W</b>	57406005	57406006



### Supplementary Light „Backseat Light“

8 A, best as reading light in the passenger car's backseat, ideal for boats and caravans as well. Easy assembly by use of the enclosed assembly kit. Light unit with slide switch, antiglare screen and integrated reflector. Flexible light arm moveable in all directions.

	BP	SP
	SU = 50	SU = 20
<b>12 V / 10 W</b>	57405002	57405003



### Superlux Halogen Hand and Reading Light

All-round light for cars, boats and caravans. Attachment of the multi-purpose ball jointed holder permanent by screw-on fastening.

12 V / 10 W halogen incandescent lamp and computer calculated reflector, optimal antiglare light distribution by prismatic lens, helix cable 0.6 to 3.0 m, safety universal plug, 8 A.

	BP	SP
	SU = 50	SU = 20
<b>with holder 12 V / 10 W</b>	57415002	57415001
<b>without holder 12 V / 10 W</b>	57415000	–



### LED Nightlight

12 V / 0.6 W, 5 LED's integrated in bendable universal plug.

	BP	SP
	SU = 100	SU = 20
<b>12 V / 0,6 W</b>	57400600	57400601



### Mini LED Spot, waterproof

12 V / 0.6 W, for lighting in wet areas or for permanent illumination and safety light. Dimensions: 14.5 x 30 mm.

	BP	SP
	SU = 100	SU = 20
<b>12 V / 0,6 W</b>	57400500	57400501

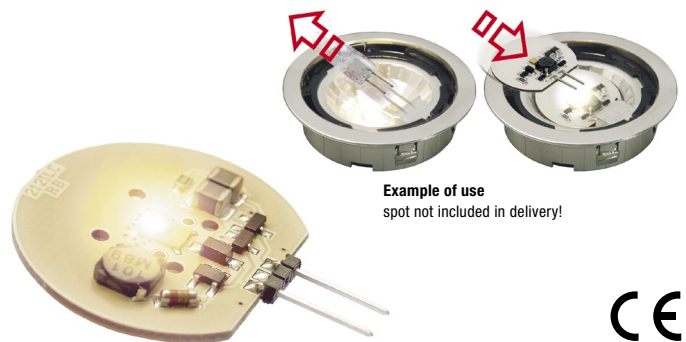

Example of use  
spot not included in delivery!



### Power LED illuminant

with G4 pin base on the side, 1.5 W. 12-24 V DC / 12 V AC, Ø 30 mm, Light-colour: warm-white 2,700 K. Keeps stable at voltage: 9-28 V DC / 9-20 V AC

	BP	SP
	SU = 100	SU = 60
<b>12-24 V</b>	57429000	57429050



### Mini LED Spot

8-30 V battery current / 2.5 W. The ballast is integrated in the lamp base. Can be pivoted and swivelled, high luminance, making it ideal as a reading and spotlight in mobile homes, trucks, boats. When used at home a 230 V power supply unit can be connected. Light colour: warm-white 2,700 K, housing: aluminium-matt

	BP	SP
	SU = 20	SU = 20
<b>without switch-key, 2.5 W</b>	57421010	57421510
<b>with switch-key, 2.5 W</b>	57421111	57421611
<b>Power LED Spot Maxi, with switch-key, 6 W</b>	57421210	-



### Surface Mounted / Built-In Power LED

8-30 V battery current / 3 W. All-purpose surface mounted / built-in LED light, with integrated ballast, pleasant warm white light colour, large radiation angle of 160°, extremely slim design, making it ideal for installation in/under cupboards and as an energy-saving light in mobile homes, trucks, boats. When used at home a 230 V power supply unit can be connected. Light colour: warm-white, housing: aluminium-matt

	BP	SP
	SU = 50	SU = 40
<b>without switch-key</b>	57423000	57423500
<b>with switch-key</b>	57423011	57423511

... future  
LED technology

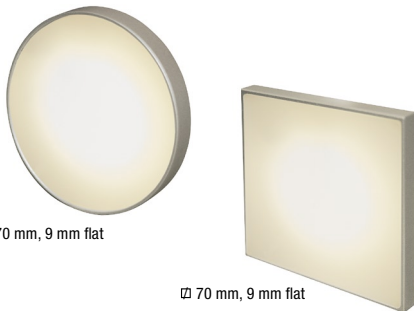

### Surface Mounted Power LED

8-30 V battery current / 3.6 W. Flat, all-purpose LED light with a large radiation angle of 160°, and an extremely slim design, making it ideal for installation in/under cupboards and as an energy-saving light in mobile homes, trucks, and boats. When used at home a 230 V power supply unit can be connected. Mounting via adhesive pads. Light colour: warm-white, 2,700 K, housing: aluminium-matt

	BP	SP
	SU = 20	SU = 20
<b>round</b>	57425000	57425500
<b>square</b>	57426000	57426500

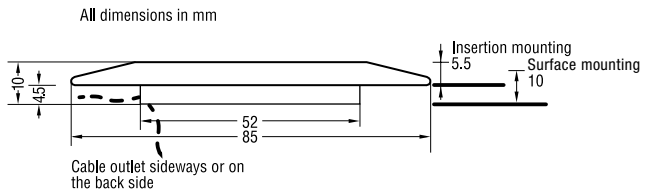

Diameter	85 mm
Height	10 mm
Operating voltage	8 – 30V
Current consumption	0.25A (bei 12V)
Power consumption	3W
LED Power	2.5W
Color temperature	2700 Kelvin
Angle of reflected beam	150°



### Surface Mounted Power LED Maxi

11-30 V battery current / 6 W. All-purpose surface mounted Power LED light. Its large angle of reflected beam and its high capacity makes it perfect for illuminating rooms. For use in cars, boats, and mobile homes. When used at home a 230 V power supply unit can be connected. Measurements: diameter 120 mm, height: 10.5 mm. Light colour: warm-white, housing: aluminium-matt

	BP	SP
	VSU = 20	SU = 20
<b>6 W</b>	57424000	57424500

... saves up to  
80% energy!