

Modular DC power protection and distribution solutions
Create space saving arrangements of fuseholders and busbars
Install quickly, easily and safely
5 year warranty

DC Modular high current busbars and fuseholders

Due to the ever increasing complexity of electrical DC systems onboard of vehicles or in stationary applications, there is a growing need for a uniform set of products that significantly improves the installation time and flexibility. The TBS DC Modular product range offers a perfect solution for this. It contains a wide range of high current busbars, fuseholders and interconnection materials. Compared to more traditional and often incompatible DC distribution products, the DC Modular system offers many innovative features.

The DC Modular product range is also a perfect companion for the TBS Expert Modular battery monitor. The footprint of this advanced battery monitor fits perfectly into the DC Modular grid, allowing optimal integration with the busbars and fuse holders.

All DC Modular products are equipped with stainless steel studs, washers and nuts for optimal corrosion resistance. Tin plated high purity copper busses provide maximum conductivity, reducing heat and improving efficiency. The base material used for the DC Modular products, is made from a special fiber reinforced compound. This material offers excellent high temperature properties, good chemical resistance and high strength. This focus on the highest quality materials, ensures long lifetimes in harsh environments. All DC Modular products are designed and assembled in The Netherlands.

Easy in-system connection access due to top locked covers by convenient thumb screws

Top sides of transparent covers are equipped with recessed locations to properly add custom labels

Special fiber reinforced base material offers excellent high temperature properties, good chemical resistance and high strength

Robust transparent covers with breakouts to allow wire access from any direction

Smart terminal design allows dual mirrored cable lug connections

Tin plated high purity copper busses provide maximum conductivity, reducing heat and improving efficiency

Stainless steel studs, nuts and washers for optimal corrosion resistance

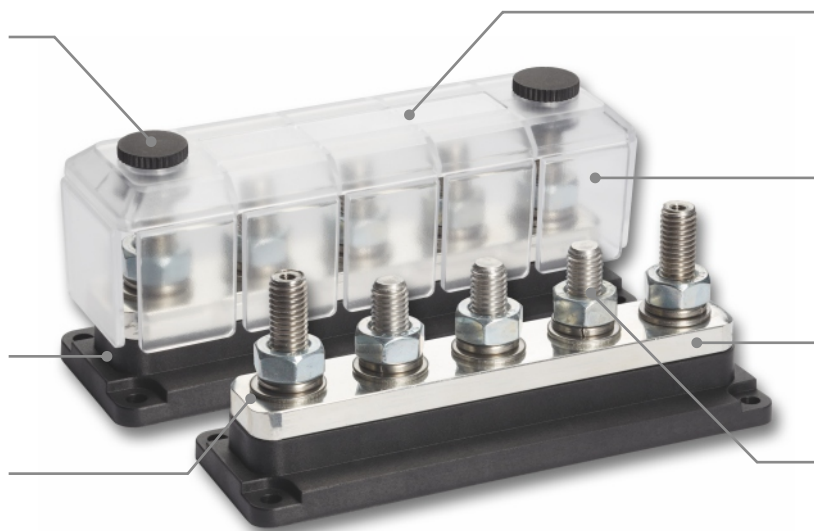

Transparent polycarbonate cover with break-out side skirts at each side, for easy cable entry



The optional adapter plate allows a mixture of high- and low power cables to be connected to the same stud

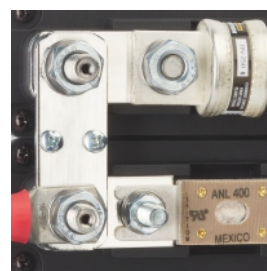

Multiple fuseholders and busbars can be connected to each other with the optional link plates



Smart terminal design allows dual mirrored cable lug connections

DC Modular high current busbars

The DC Modular high current busbars are used to distribute high DC currents to a number of connected cables, or other DC Modular family members. The solid and compact design, as well as the possibility to link up multiple busbars on a fixed grid, make these products the best choice for all professional DC power systems. The high current busbars are available with M8 or M10 stud sizes.

Features:

- Stainless steel studs, nuts and washers for optimal corrosion resistance
- Tin plated high purity copper busses provide maximum conductivity, reducing heat and improving efficiency
- Special fiber reinforced base material offers excellent high temperature properties, good chemical resistance and high strength
- Unique grid optimized footprints allow space saving arrangements of multiple products
- Common interconnection heights for easy combining of multiple products using link plates
- Robust transparent covers with breakouts to allow wire access from any direction
- Smart terminal design allows dual mirrored cable lug connections
- Easy in-system connection access due to top locked covers

3 stud Busbar

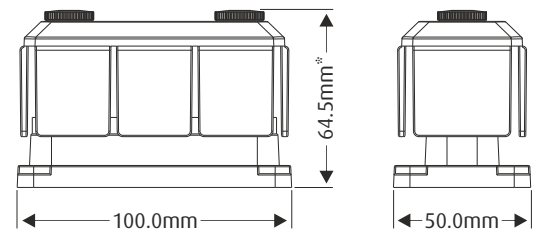

* Total height without cover is 56.3mm

Model	Art.no.	Grid size	Maximum Current	Max. Voltage ¹⁾	Connection stud size
DCM 3xM8 Busbar	5073160	1 x 2	600A	50V	M8
DCM 3xM10 Busbar	5073180	1 x 2	600A	50V	M10



¹⁾ Higher voltages may require additional safety measures

5 stud Busbar

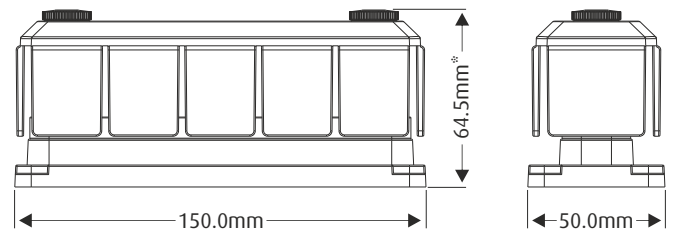

* Total height without cover is 56.3mm

Model	Art.no.	Grid size	Maximum Current	Max. Voltage ¹⁾	Connection stud size
DCM 5xM8 Busbar	5075160	1 x 3	600A	50V	M8
DCM 5xM10 Busbar	5075180	1 x 3	600A	50V	M10



¹⁾ Higher voltages may require additional safety measures

DC Modular insulated studs

The DC Modular single and dual insulated studs are ideal parts to extend cables, add power taps or form termination end-points. The solid and compact design, as well as the possibility to link these up with other DC Modular family members, make these products the best choice for all professional DC power systems. The insulated studs are available with M8 or M10 stud sizes.

Features:

- Stainless steel studs, nuts and washers for optimal corrosion resistance
- Special fiber reinforced base material offers excellent high temperature properties, good chemical resistance and high strength
- Unique grid optimized footprints allow space saving arrangements of multiple products
- Common interconnection heights for easy combining of multiple products using link plates
- Robust transparent covers with breakouts to allow wire access from any direction
- Top sides of transparent covers are equipped with recessed locations to properly add custom labels (Dual insulated stud only)
- Smart terminal design allows dual mirrored cable lug connections
- Easy in-system connection access due to top locked covers

Single Insulated Stud

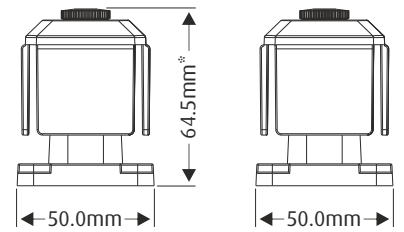

* Total height without cover is 56.3mm

Model	Art.no.	Grid size	Maximum Current	Max. Voltage ¹⁾	Connection stud size
DCM 1xM8 Single Stud	5071160	1 x 1	N/A	50V	M8
DCM 1xM10 Single Stud	5071180	1 x 1	N/A	50V	M10

¹⁾ Higher voltages may require additional safety measures



Dual Insulated Stud

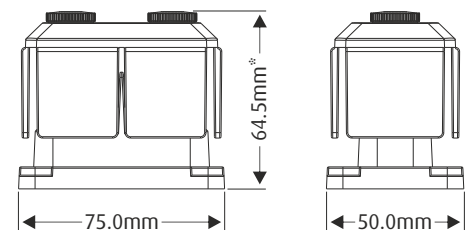

* Total height without cover is 56.3mm

Model	Art.no.	Grid size	Maximum Current	Max. Voltage ¹⁾	Connection stud size
DCM 2xM8 Dual Stud	5072160	1 x 1.5	N/A	50V	M8
DCM 2xM10 Dual Stud	5072180	1 x 1.5	N/A	50V	M10

¹⁾ Higher voltages may require additional safety measures



DC Modular fuseholders

A wide range of fuseholders are available in the DC Modular lineup, covering fuse Amp ratings from 35A up to 600A. Fuseholders are offered for the Mega®, ANL and Class-T type of fuses, providing solutions for a wide range of applications. The solid and compact design, as well as the possibility to link up multiple fuseholders on a fixed grid, make these products the best choice for all professional DC power systems.

Features:

- Stainless steel studs, nuts and washers for optimal corrosion resistance
- Tin plated high purity copper busses provide maximum conductivity, reducing heat and improving efficiency
- Special fiber reinforced base material offers excellent high temperature properties, good chemical resistance and high strength
- Unique grid optimized footprints allow space saving arrangements of multiple products
- Common interconnection heights for easy combining of multiple products using link plates (except Mega and ANL (300A) fuseholders)
- Robust transparent covers with breakouts to allow wire access from any direction
- Smart terminal design allows dual mirrored cable lug connections
- Easy in-system connection access due to top locked covers (except Mega and ANL (300A) fuseholders)

Mega Fuseholder

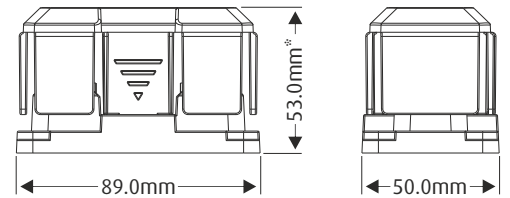

* Total height without cover is 43.5mm

Model	Art.no.	Grid size	Fuse range ¹⁾	Max. Voltage ²⁾	Connection stud size
DCM Mega Fuseholder	5073300	1 x 1.78 ³⁾	40 .. 300A	50V	M8

¹⁾ Compatible with Littelfuse® 'Mega' and Cooper Bussmann® 'AMG' fuses

²⁾ Higher voltages may require additional safety measures

³⁾ The Mega fuseholder is optimized for stand-alone use and is not compatible with link- and adapter plates



ANL Fuseholder (300A)

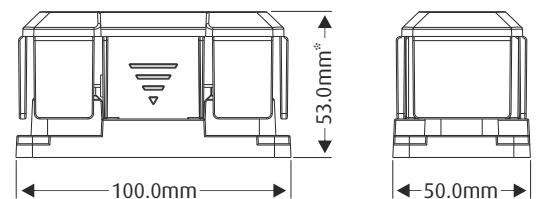

* Total height without cover is 43.5mm

Model	Art.no.	Grid size	Fuse range ¹⁾	Max. Voltage ²⁾	Connection stud size
DCM ANL Fuseholder (300A) M8	5073500	1 x 2 ³⁾	35 .. 300A	50V	M8
DCM ANL Fuseholder (300A) M10	5073510	1 x 2 ³⁾	35 .. 300A	50V	M10

¹⁾ M8 version compatible with Littelfuse® 'CNN' and 'CNL' plus Cooper Bussmann® 'ANL' and 'ANN' fuses
M10 version compatible with Littelfuse® '157.57' plus SIBA '90 058 05' fuses

²⁾ Higher voltages may require additional safety measures

³⁾ The ANL fuseholder has a grid optimized footprint but is not compatible with link- and adapter plates



DC Modular fuseholders

ANL Fuseholder (600A)

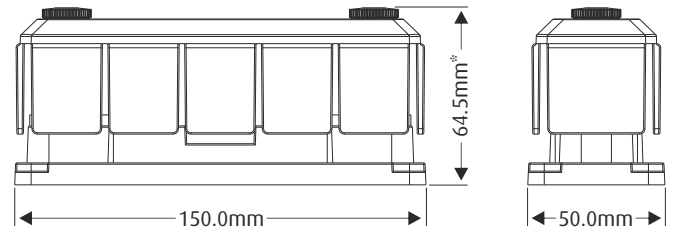

* Total height without cover is 56.3mm

Model	Art.no.	Grid size	Fuse range ¹⁾	Max. Voltage ²⁾	Connection stud size
DCM ANL Fuseholder (600A) M8	5073550	1 x 3	35 .. 600A	50V	M8
DCM ANL Fuseholder (600A) M10	5073560	1 x 3	35 .. 600A	50V	M10



¹⁾ M8 version compatible with Littelfuse® 'CNN' and 'CNL' plus Cooper Bussmann® 'ANL' and 'ANN' fuses

M10 version compatible with Littelfuse® '157.57' plus SIBA '90 058 05' fuses

²⁾ Higher voltages may require additional safety measures

Class-T Fuseholder (225-400A)

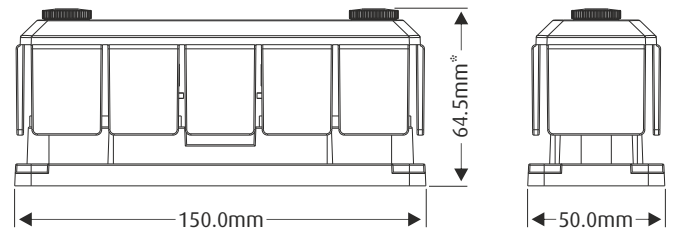

* Total height without cover is 56.3mm

Model	Art.no.	Grid size	Fuse range ¹⁾	Max. Voltage ²⁾	Connection stud size
DCM Class-T Fuseholder (400A)	5073850	1 x 3	225 .. 400A	50V	M10



¹⁾ Compatible with Littelfuse® 'JLLN', Cooper Bussmann® / Edison® 'JJN' and 'TJN' and Mersen® 'A3T' fuses

²⁾ Higher voltages may require additional safety measures

Class-T Fuseholder (450-600A)

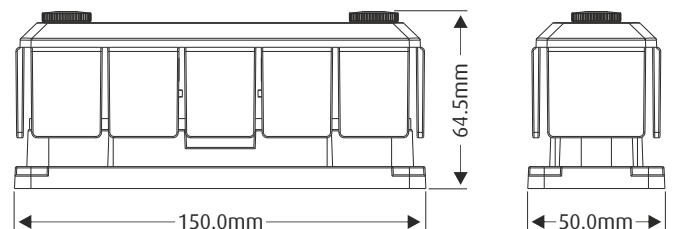

* Total height without cover is 56.3mm

Model	Art.no.	Grid size	Fuse range ¹⁾	Max. Voltage ²⁾	Connection stud size
DCM Class-T Fuseholder (600A)	5073880	1 x 3	450 .. 600A	50V	M10



¹⁾ Compatible with Littelfuse® 'JLLN', Cooper Bussmann® / Edison® 'JJN' and 'TJN' and Mersen® 'A3T' fuses

²⁾ Higher voltages may require additional safety measures

DC Modular accessories

Due to the common interconnection heights, smart space saving arrangements of multiple DC Modular products can be made by linking these together using the optional Link Plates. We have managed to offer only two Link Plate sizes to create all possible combinations. Both Link Plates are compatible with M8 and M10 studs. Additionally, we have equipped the Link Plates with two M4 screws to provide convenient connection points for smaller cables. For this purpose only, we are also offering an Adapter Plate which allows a mixture of high and low power cables to be connected to the same stud. The Adapter Plate can be used on M8 and M10 studs and offers four connection points for smaller cables.

Features:

- Tin plated high purity copper busses provide maximum conductivity, reducing heat and improving efficiency
- Stainless steel M4 screws and washers provide convenient connection points for smaller cables
- Compatible with M8 and M10 studs

Link Plate 41mm

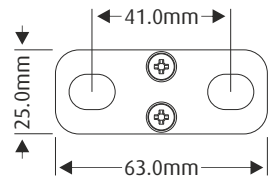

Model ¹⁾	Art.no.	Max. Current ²⁾	Dimensions (L x W)	Accepts stud size
DCM Link Plate 41mm	5079062	600A	63.0 x 25.0mm	M8 + M10

¹⁾ Not compatible with "Mega" and "ANL (300A)" fuseholders

²⁾ Current capacity can be doubled by stacking two Link Plates (after removal of M4 screws)

End to end linking

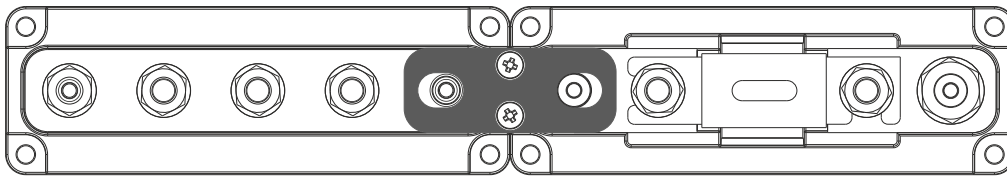

For linking to and from:

- DCM 1xM8/M10 Single Stud
- DCM 2xM8/M10 Dual Stud
- DCM 3xM8/M10 Busbar
- DCM 5xM8/M10 Busbar
- DCM ANL Fuseholder (50V/600A)
- DCM Class-T Fuseholder (50V/225-400A)
- DCM Class-T Fuseholder (50V/450-600A)

End to side linking

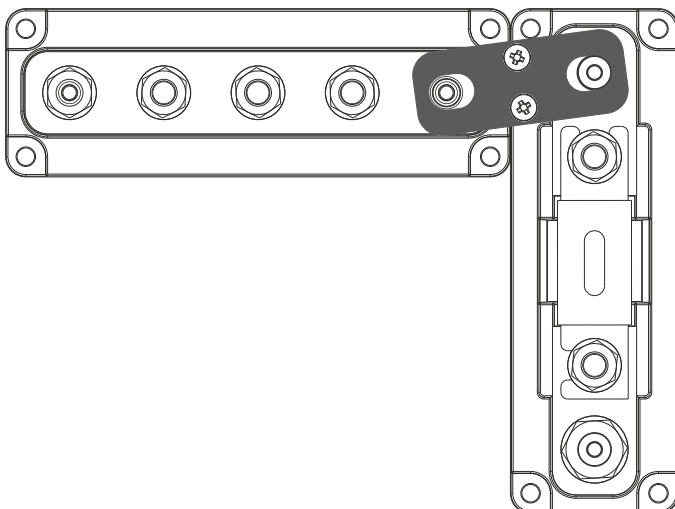

For linking to and from:

- DCM 2xM8/M10 Dual Stud
- DCM 3xM8/M10 Busbar
- DCM 5xM8/M10 Busbar
- DCM ANL Fuseholder (50V/600A)
- DCM Class-T Fuseholder (50V/225-400A)
- DCM Class-T Fuseholder (50V/450-600A)

Link Plate 50mm

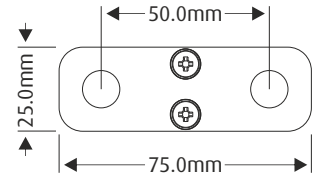

Model ¹⁾	Art.no.	Max. Current ²⁾	Dimensions (L x W)	Accepts stud size
DCM Link Plate 50mm	5079072	600A	75.0 x 25.0mm	M8 + M10

¹⁾ Not compatible with "Mega" and "ANL (300A)" fuseholders

²⁾ Current capacity can be doubled by stacking two Link Plates (after removal of M4 screws)

Side to side linking

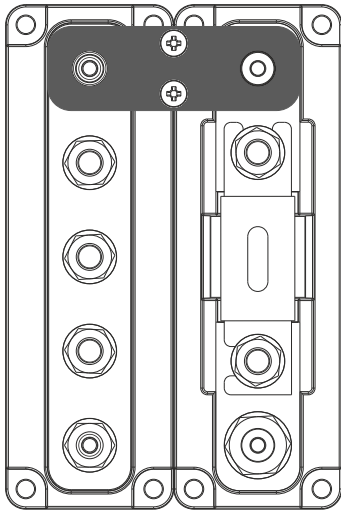

For linking to and from:

- DCM 1xM8/M10 Single Stud
- DCM 2xM8/M10 Dual Stud
- DCM 3xM8/M10 Busbar
- DCM 5xM8/M10 Busbar
- DCM ANL Fuseholder (50V/600A)
- DCM Class-T Fuseholder (50V/225-400A)
- DCM Class-T Fuseholder (50V/450-600A)

Adapter Plate

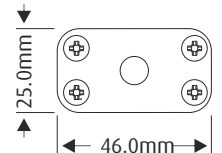

Model ¹⁾	Art.no.	Max. Current	Dimensions (L x W)	Accepts stud size
Adapter Plate (1xM8/M10 to 4xM4)	5079020	600A	46.0 x 25.0mm	M8 + M10

¹⁾ Not compatible with "Mega" and "ANL (300A)" fuseholders

For converting an M8 or M10 stud to 4xM4 fork/ring terminals

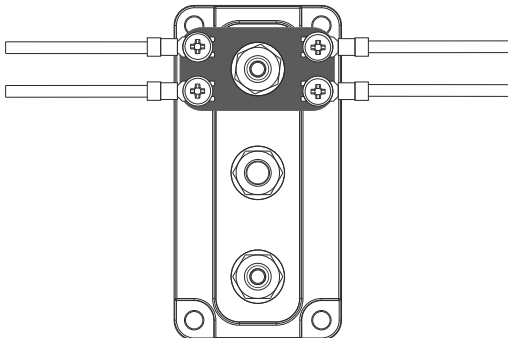

www.tbs-electronics.com



TBS Electronics BV
De Marowijne 3
1689AR Zwaag
The Netherlands

All specifications are subject to change without notice
DCM-EN-REVD