



Thule XT Kit 3020

> Instructions

SEAT Leon I, 3-dr Hatchback, 99-05

SEAT Leon I, 5-dr Hatchback, 99-05

SEAT Toledo II, 4-dr Sedan, 98-04

This kit is only for vehicles with fixpoint mounting.

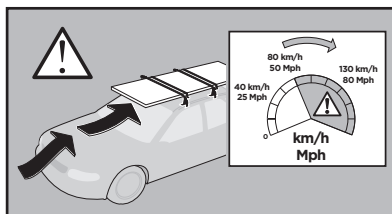
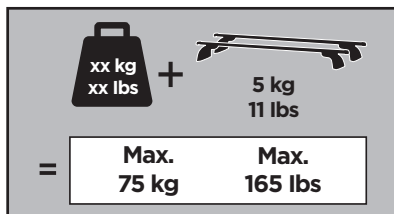
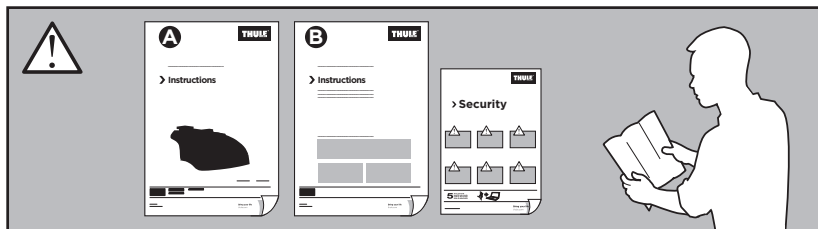

ISO 11154-E

183020

C.20130527
509-3020-02

Bring your life
thule.com

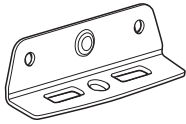

◀ 08 x4

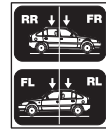
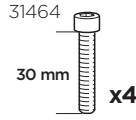

x1

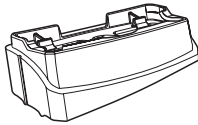

◀ 22 x2

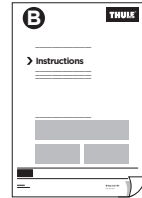

x1

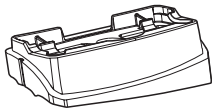

◀ 23 x2

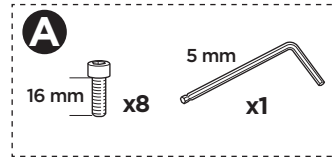

1

08



22



23

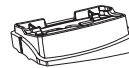

08



08

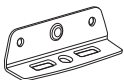

23

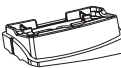

22

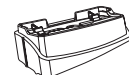

08

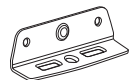

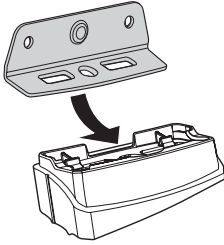
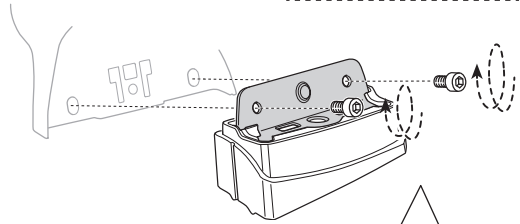
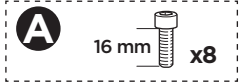
2**A****B**

EN Only a few turns
DE Nur wenige Umdrehungen
FR Quelques tours uniquement
NL Slechts enkele slagen
IT Solo qualche giro
ES Sólo algunas vueltas
PT Noções básicas
SV Endast några varv
DK Kun nogle få omgange
NE Bare noen få omdreinger
FI Vain muutama kierros
ET Ainult mõni pööre
LV Tikai daži apgriezieni
LT Tik keli pasukimai
PL Wystarczy kilka obrotów
RU Только несколько оборотов

UK Лише декілька обертів
BG Само няколко завъртания
CS Pouze několik otáček
SK Len niekoľko otáčok
SL Le nekaj obratov
HR/BiH Samo nekoliko okreta
RO Doar câteva rotiri
HU Csak néhány fordítás
EL Μόνο λίγες περιστροφές
TR Yalnızca birkaç tur

بعض دورات فقط

AR

רק מספר סיבובים

HE

ZH 仅几圈
JA 2～3回転のみ
KO 몇 번만 돌리면 됨
TH เพียงสองสามรอบ

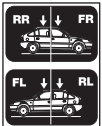
3

x1

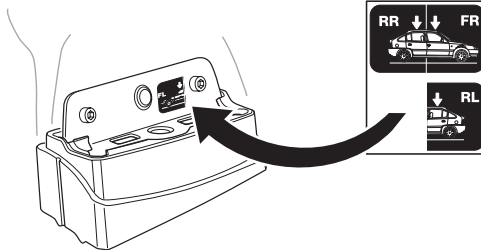

4

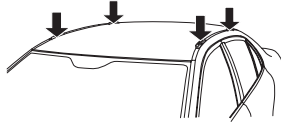

A

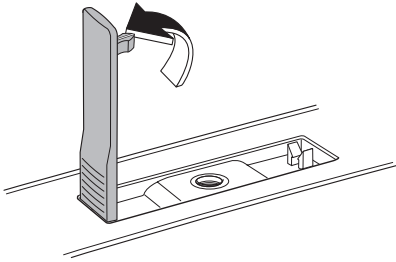

B

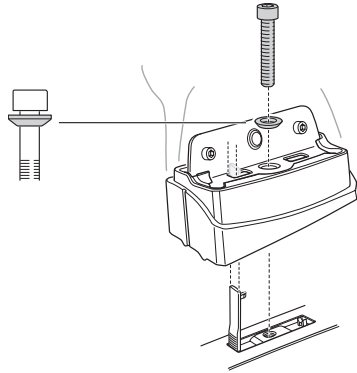

5

A



6 Nm

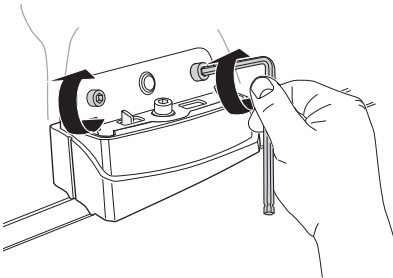

B

4 Nm

