

**17L
4213**

Nissan NP300 Navara D23, Md. 2016

EU-pedestrian protection bar 76 mm

EU-Personenschutzbügel 76 mm

Protection avant, homologuée CEE, 76 mm

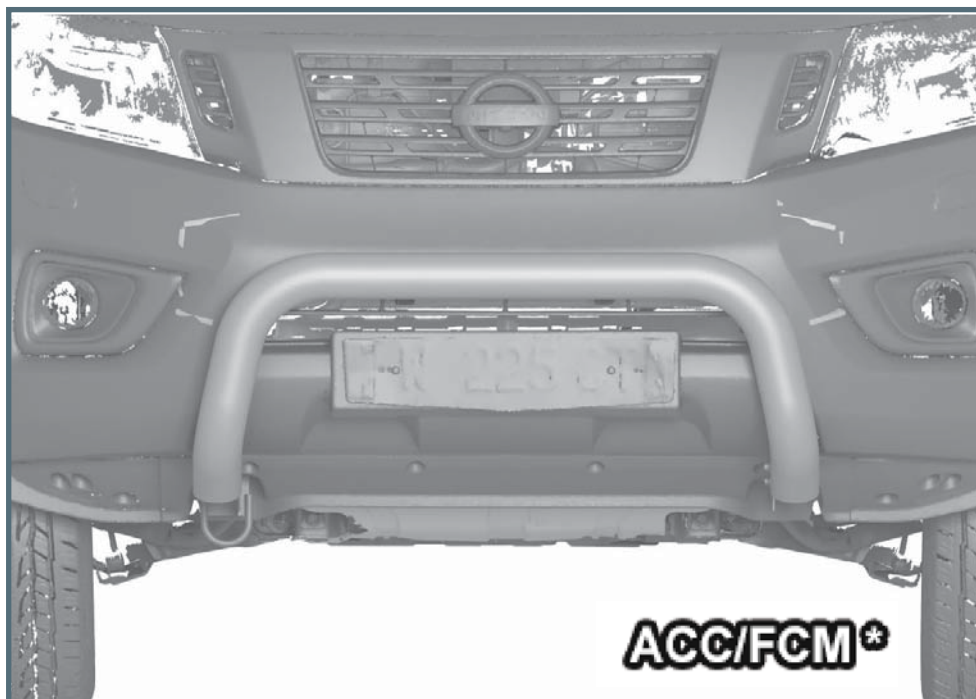

*Compatible with Automatic Cruise Control /Forward Collision Mitigation
Kompatibel mit Abstandsregeltempomat /Auffahrvermeidungs-oder warnsystem
compatible avec radar de régulation de distance/ freinage autonome d'urgence



ASSEMBLY INSTRUCTION

Montageanleitung • Instructions de montage

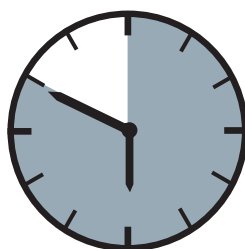

50 Minuten

Artikel-Nr:

17L4213 stainless steel

17L5213 black steel

Revision 2: 18.05.2016



13
17
19

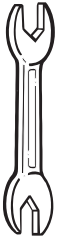

M8 (A2):
21,4 Nm
M8:
25 Nm
M10:
50 Nm
M12:
87 Nm

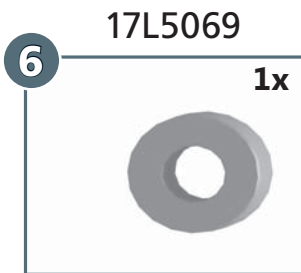
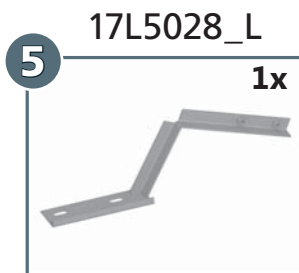
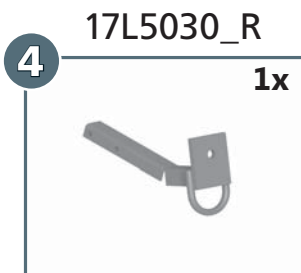
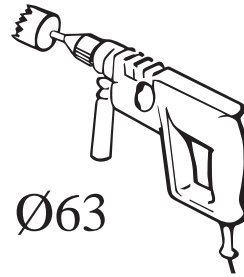
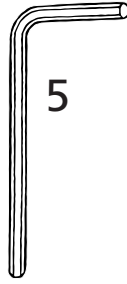
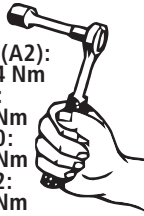

a		M8x20; ähnl. ISO 7380 A2	4x
b		M8; DIN 934 Zn	2x
c		M8x25; DIN 933 A2	2x
d		M12x55; DIN 933 Zn	1x
e		M10; DIN 934 Zn	2x
f		M12; DIN 934 Zn	1x
g		Ø 8; DIN 127 Zn	2x
h		Ø 8; DIN 127 A2	2x
i		Ø 10; DIN 127 Zn	2x
j		Ø 12; DIN 127 Zn	1x
k		Ø 8,4; DIN 125 Zn	2x
l		Ø 8,4; DIN 9021 A2	2x
m		Ø 10,5; DIN 9021 Zn	2x
n		Ø 13; DIN 9021 Zn	2x
o		SW 13	2x

