

15U 4113

Isuzu D-Max; Md.2012+2017

EU-pedestrian protection bar 76 mm with cross pipe 51 mm

EU-Personenschutzbügel 76 mm mit Querrohr 51 mm

Protection avant, homologuée CEE, 76 mm, traverse 51 mm

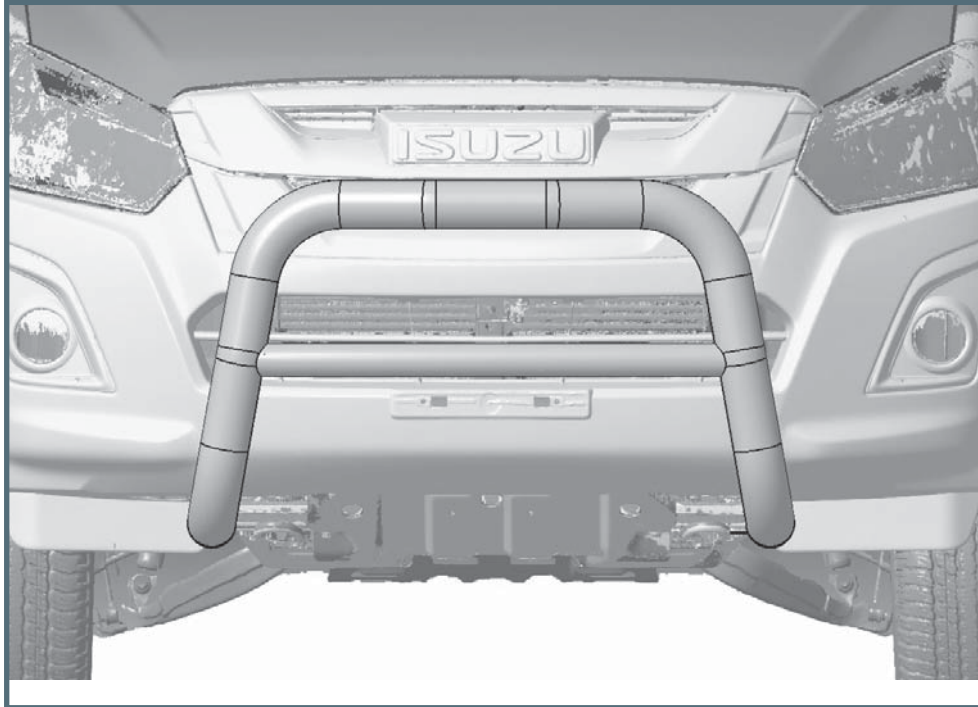

ASSEMBLY INSTRUCTION

Montageanleitung • Instructions de montage

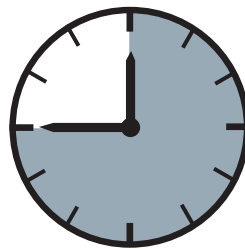

45 Minuten

Artikel-Nr.:

15U4113 Stainless Steel

15U5113 black Steel

Revision 6: 23.08.2017



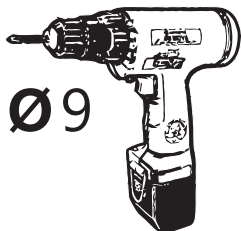
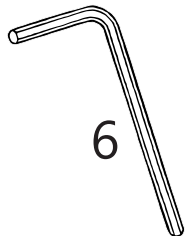
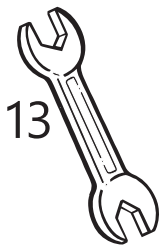

M8 (A2):
21,4 Nm
M8:
25 Nm

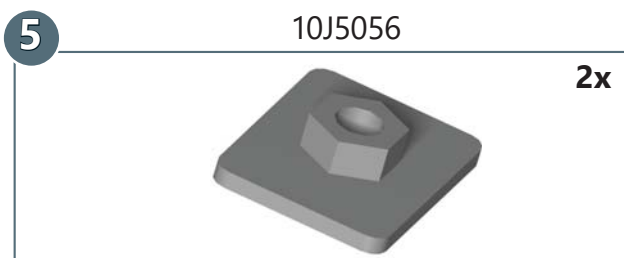
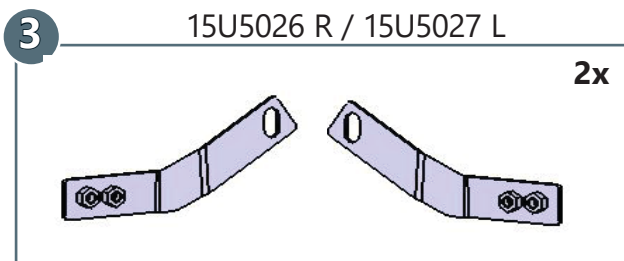
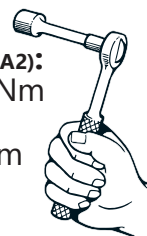

| | | | |
|---|--|----------------------------|----|
| a | | M8 x 20; ähnl. ISO 7380 A2 | 2x |
| b | | M8 x 25; DIN 933 A2 | 2x |
| c | | M8 x 30; DIN 933 Zn | 2x |
| d | | Ø 8,4; DIN 9021 A2 | 2x |
| e | | Ø 8,4; DIN 125 Zn | 2x |
| f | | Ø 8; DIN 127 A2 | 2x |
| g | | Ø 8; DIN 127 Zn | 2x |
| h | | SW13 | 2x |

