

Technical Manual

Installation and Service

BlazeCut Automatic Fire Suppression System

C Series Direct Clean Agent Systems

CEA116, CFK116

CEA118, CFK118

CEA126, CFK126

CEA128, CFK128



TABLE OF CONTENTS

1	INTRODUCTION	4
2	BASIC INFORMATION ABOUT THE SYSTEM	5
2.1	EXPLANATION OF MODEL NAME CAPTION	5
2.2	TECHNICAL SPECIFICATIONS AND TYPES OF DLP SYSTEMS	6
2.3	USE OF THE SYSTEM	7
3	SYSTEM DESIGN LIMITATIONS	8
3.1	LPCB APPLICATIONS (FK-5-1-12 ONLY).....	8
3.2	VOLUME COVERAGE	9
4	COMPONENTS OF THE SYSTEM AND THEIR DESCRIPTION	15
4.1	CYLINDERS FOR EXTINGUISHING AGENT.....	15
4.2	CYLINDER VALVES	18
4.3	BLAZETUBE DETECTION	22
4.4	PRESSURE GAUGES	24
4.5	BLAZETUBE PUSH-IN CONNECTORS	24
4.6	BLAZETUBE END-OF-LINE DEVICES.....	25
4.7	FASTENING MATERIAL	26
4.8	LABELS.....	28
5	DEFINITION OF LEGAL REQUIREMENTS	30
6	INFORMATION ON EXTINGUISHING AGENTS USED	30
6.1	DESCRIPTION OF HFC-227EA.....	30
6.2	DESCRIPTION OF FK-5-1-12	30
6.3	PERMISSIBLE USES OF EXTINGUISHING AGENTS.....	31
6.4	SOME PHYSICAL AND CHEMICAL PROPERTIES	32
6.5	IMPROPER USES OF THE EXTINGUISHING AGENT	33
6.6	WARNINGS.....	33
6.7	HANDLING OF HFC GASES	34
7	INSTRUCTIONS FOR INSTALLATION OF THE SYSTEM	34
7.1	GENERAL RULES	34
7.2	INSTALLATION OF THE CYLINDER AND BRACKET.....	35
7.3	INSTALLATION OF THE BLAZETUBE DETECTION	38
7.4	PRESSURIZATION OF THE CYLINDER AND THE DETECTION SYSTEM.....	43
7.5	FINAL INSPECTION OF THE SYSTEM INSTALLATION.....	47
8	REGULAR INSPECTION AND MAINTENANCE OF THE FIRE SUPPRESSION SYSTEM	47
8.1	OVERALL INSPECTION OF THE SYSTEM	48

AUTOMATIC FIRE SUPPRESSION SYSTEMS



8.2	INSPECTION OF PRESSURE IN THE SYSTEM	48
8.3	PRESSURIZATION OF THE SYSTEM.....	49
8.4	INSPECTION OF WEIGHT OF THE EXTINGUISHING AGENT IN THE SYSTEM	49
8.5	REMOVAL OF THE SYSTEM FROM SERVICE	50
9	OPERATION OF THE BLAZECUT SYSTEM IN CASE OF FIRE	51
10	RESTORATION OF ACTIVITY OF BLAZECUT SYSTEM IN CASE OF FIRE	52
11	SYSTEM DEACTIVATION	53
12	MAINTENANCE OF THE SYSTEM, REPLACEMENT OF COMPONENTS	53
12.1	GENERAL RULES	53
12.2	REPLACEMENT OF THE CYLINDER	53
12.3	REPLACEMENT OF THE BLAZETUBE DETECTION	54
12.4	CLEANING THE SYSTEM.....	55
12.5	DECLARATION OF CONFORMITY	55
13	PRODUCT TRAINING.....	56
14	LIST OF ANNEXES.....	56
ANNEX 1: SIGNALLING DEVICES		57
A1.1.	SIGNALLING UNITS.....	57
A1.2.	ALARM PANEL	58
ANNEX 2: PRESSURE MONITORING AND ELECTRICAL COMPONENTS.....		59
A2.1.	PRESSURE TRANSDUCER ATA100.....	59
A2.2.	PRESSURE SWITCH APS001-xx.....	60
A2.3.	ELECTRICAL CABLES, CONDUITS AND CONNECTORS.....	62
ADDITIONAL NOTES		64

1 INTRODUCTION

1.1.1 MANUFACTURER INFORMATION

BlazeCut s.r.o., Triblavinská 3191, 90025 Chorvátsky Grob, Slovakia

GLOBAL HEAD OFFICE

BlazeCut Pty Ltd, 45 Evans St, Balmain NSW 2041 Australia

+61 2 8006 1300

www.blazecut.com; customerservice@blazecutgroup.com

1.1.2 INSTRUCTIONS FOR USE OF THE MANUAL

This manual is intended to supply technical information for the trained and authorized by BlazeCut Group. Any personnel performing installation, inspection, maintenance or replacement of components with the BlazeCut system shall have this manual available and proceed solely in accordance with it. Failure to follow the instructions in this manual and any other BlazeCut manuals may result in system malfunctioning, causing damage to the protected equipment and presents serious danger to the life and health of others.

1.1.3 SAFETY FIRST

Please read this manual in its entirety. Operation and installation instructions need to be fully understood before this BlazeCut product is installed. Failure to do so may void warranty. Your local governing regulations for safety and compliance must be followed.

1.1.4 WARNINGS AND CAUTIONS



This symbol within the manual represents warning of specific risks, dangers, or warning of described procedures. Failure to follow the instructions in the text marked with this symbol may result in loss of warranty, damage to property, threat to safety or life of persons performing the operation on the system or persons in the vicinity. Do not proceed without following the instructions marked with such symbols.

1.1.5 FURTHER INFORMATION

BlazeCut® is a registered trademark of BlazeCut and is recorded in the Register of Community Trade Marks.

If any of the instructions in this manual are unclear or in case of further questions, contact the BlazeCut Team.

This document is the property of BlazeCut It is prohibited to reproduce it, copy it in whole or in part, or provide third parties with any related information without prior written consent of BlazeCut.



WARNING

Please ensure that the safety instructions are fully understood before the equipment is put into service.

Do not modify any part of the BlazeCut components as this may cause serious injury or a failure of the system.

Always wear the appropriate protective equipment and clothing whilst installing or servicing.

2 BASIC INFORMATION ABOUT THE SYSTEM

2.1 EXPLANATION OF MODEL NAME CAPTION

C FK 126-1.8-3

Product line

C – Cylinder Series systems

Extinguishing agent

EA – HFC-227ea

FK – FK-5-1-12

Valve series

116 – with one outlet for Ø 6 mm BlazeTube detection

118 – with one outlet for Ø 8 mm BlazeTube detection

126 – with two outlets for Ø 6 mm BlazeTube detections

128 – with two outlets for Ø 8 mm BlazeTube detections

Quantity of extinguishing agent

0.9 – 0.9 kg of agent

1.8 – 1.8 kg of agent

3.75 – 3.75 kg of agent

Lower G1/8" port on a valve (126 and 128 valves only)

0 – plug FVP1B02

3 – M10x1 adapter FVABM0210 with a plug

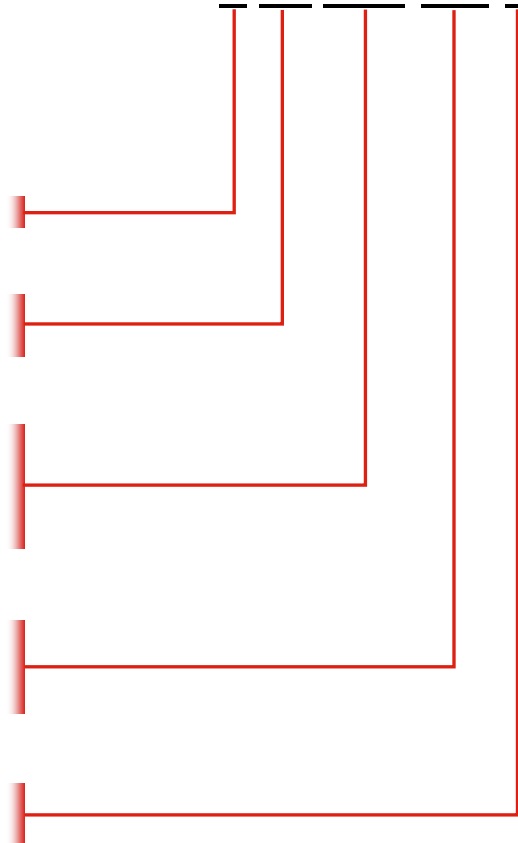

Example 1: CFK126-1.8-3 – includes BlazeCut system with one cylinder (C) with the extinguishing agent used FK-5-1-12 (FK), with the valve type 126 (126), total amount of the extinguishing agent 1.8 kg (-1.8), an additional M10 adapter on the lower G1/8" port (-3).

2.1.1 DESCRIPTION OF THE SYSTEM

Commercial name: BlazeCut

Characteristics: Clean Agent Automatic fire suppression system

Type: Cylinder Series (C Series), Direct Low Pressure (DLP)

Examples of applications:

- engine compartments of mobile equipment, boats, buses and vehicles
- electrical switchboards, fuse boxes, electrical supply sources, battery spaces,
- network installations, voltage junctions,
- server racks, audio-video equipment,
- fume cabinets,
- telecom tower shelters,
- elevator engine rooms,
- cable trays,
- CNC machining centres,
- wind turbines,
- 3D printers, laser cutters,
- others.

Functionality: BlazeCut Direct Low-Pressure System suppresses fire automatically without any external power source. Extinguishing agent is stored in a cylinder. The cylinder is closed with a valve, which keeps the pressure in the cylinder and releases the agent.

The system is referred to as direct, which means that the activation and distribution of the agent is secured by heat detection tubing – BlazeTube. The fire suppression system operates by detecting fire and also application of the agent using a BlazeTube detection connected to the cylinder valve. The BlazeTube detection is placed in the protected enclosure and is under constant pressure. In case of a fire the BlazeTube detection degrades by the effect of a fire or high temperature. When the BlazeTube detection is disrupted, the agent is released through created “nozzle”. This system is independent of any electrical supply and operates solely on physical principles.

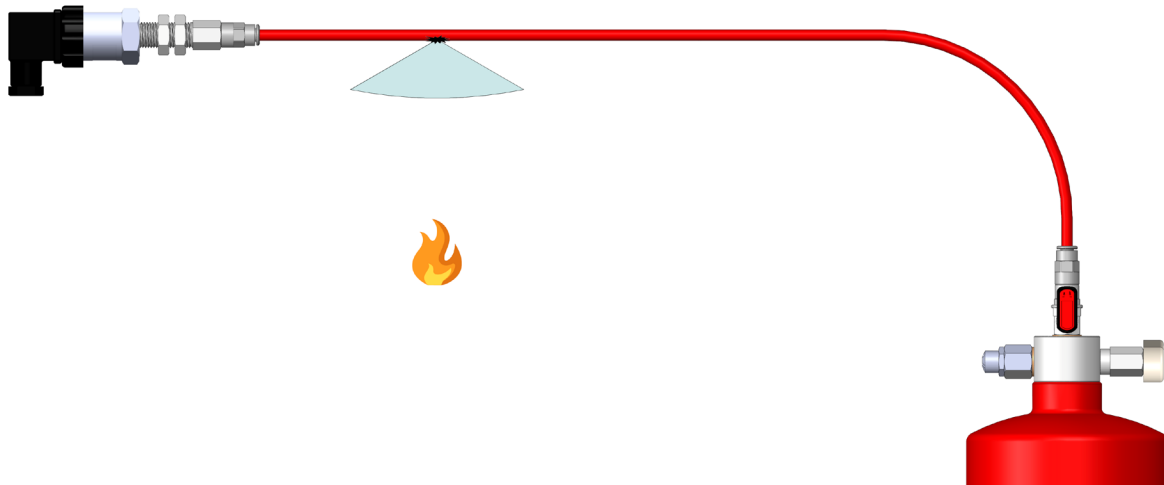

Principle of operation of BlazeCut DLP system

Systems BlazeCut C(EA, FK)(126, 128) with valves 126 and 128 have two outlets to connect two BlazeTube detections. This allows for better coverage of the enclosure, higher flow rate of the agent in a loop configuration or greater variability of enclosures protection.

2.1.2 OPTIONAL COMPONENTS

Installation, use, function and service of selected optional components is described in annexes of this Installation and service manual or supplied as a separate manual. For more information contact the supplier.

2.2 TECHNICAL SPECIFICATIONS AND TYPES OF DLP SYSTEMS

Table 1: DLP basic kits with HFC-227ea

Model number	Valve type	Agent quantity [kg]	BlazeTube size [mm]	BlazeTube outlets	Operating pressure at 20 °C [bar]	Operating pressure range [bar]	Operating temperature range [°C]
CEA116-1	116	1	ø 6	1	12	8 – 20	-20 to +55
CEA116-2		2					
CEA116-4		4					
CEA118-1	118	1	ø 8				
CEA118-2		2					
CEA118-4		4					
CEA126-2	126	2	ø 6	2			
CEA126-4		4					
CEA128-2	128	2	ø 8				
CEA128-4		4					

Table 2: DLP basic kits with FK-5-1-12

Model number	Valve type	Agent quantity [kg]	BlazeTube size [mm]	BlazeTube outlets	Operating pressure at 20 °C [bar]	Operating pressure range [bar]	Operating temperature range [°C]
CFK116-1.25	116	1.25	ø 6	1	15	12 – 20	-20 to +60
CFK116-2.5		2.5					
CFK116-5		5					
CFK118-1.25	118	1.25	ø 8	1	15	12 – 20	-20 to +60
CFK118-2.5		2.5					
CFK118-5		5					
CFK126-2.5	126	2.5	ø 6	2	15	12 – 20	-20 to +60
CFK126-5		5					
CFK128-2.5	128	2.5	ø 8	2	15	12 – 20	-20 to +60
CFK128-5		5					

Table 3: Installation characteristics for BlazeCut DLP systems

Parameter	Description
Test pressure of pressure equipment	30 bar
Amount of agent	1 to 5 kg
Type of extinguishing agent	HFC-227ea or FK-5-1-12
Expellant gas	nitrogen
Pneumatic activation	yes
Connection to a fire alarm or other warning device	with AAP210, AAP310
Display, monitor and provide a low-pressure alarm	with APS001/ATA100 + AAP210; APS001 + custom panel
Connection to a sounder or other alarm activation system	with APS001 + signalling unit
Isolating power supplies and auxiliary equipment such as fan units to the enclosure upon system activation	with APS001, AAP210 or AAP310

NOTE

As a general rule, it shall not be possible for the user to isolate any electrical power supply or alarm connections to the DLP system without also isolating the power supply to the enclosure, and/or placing the system into an alarm state. If the end user does not require operational shut down of the enclosure during DLP equipment maintenance, this shall be clearly acknowledged and confirmed in written form by the installer to the end user.

2.3 USE OF THE SYSTEM

The BlazeCut system is designed for protection of closed spaces from fire using volume or local fire suppression. It is not intended for use as a whole room, building fire protection system or where people are present.

The fire suppressing properties depend on many factors, including the size of the protected enclosure, the properties of the flammable substances in the space, shape and degree of closure of the area, the possibility of placement of the BlazeTube detection, air circulation etc. In order to reach desired extinguishing concentration and effective use of BlazeCut system consult the choice of type, amount of agent and cylinders, type of extinguishing agent and installation method with the supplier of the system.

In order to achieve accurate design of the system, it is necessary to obtain the following information:

- the dimensions of the protected area,
- openness of the protected area and airflow in it,
- the nature of fire risk in the protected area (presence of flammable materials, their amount, location),
- layout of the protected enclosure,
- sites with the highest probability of fire (presence of possible ignition sources of fire),
- placement options of the system within the protected area (especially the location of the cylinder and BlazeTube detection).

It is always recommended to discuss the potential fire risk factors in the protected enclosure with a local fire protection specialist who has knowledge about the protected enclosure and this information is provided to the supplier of the system. A BlazeCut risk assessment template is available for this purpose if required.

It is also necessary that the conditions in the protected area are in accordance with the permissible parameters of the system, especially the lowest and highest temperature in the protected area.

Remember that there are many factors and variables that can affect the extinguishing process in event of fire. It is not possible to guarantee total suppression of fire in the protected enclosure under all circumstances.

The BlazeCut system is designed to protect equipment in closed spaces. Use in partially or completely open spaces or spaces with strong air circulation may significantly decrease the efficiency of the system.

In case of forced ventilation in protected enclosure after activation of the system the ventilation shall be switched-off immediately to avoid venting of the agent from the protected area. In such case, it is recommended to provide automatic cut-off of ventilation when BlazeCut system is activated (e.g., with the Pressure Switch APS001-xx).

Use of the system is also limited by the properties of extinguishing agent and its possible application. Detailed information is described in Chapter [6.3](#).

2.3.1 WARNINGS



Install and use BlazeCut system only with originally supplied components. Do not replace anything in the system, use only original components and spare parts. The use of external components not approved by the manufacturer, for example beacons and alarms, will not be the responsibility of BlazeCut and no warranty or claim will be acknowledged in this regard.



BlazeCut system is not compatible with other fire suppression systems, do not try to connect the system to any other equipment.



The system may be installed, maintained and repaired only by persons trained or authorized by the manufacturer and also holding relevant professional qualification depending on the procedure. Unprofessional interference with the system may cause malfunction of the system and provides threat to safety and health of people.



The system is not designed to be used as portable fire extinguisher. Do not try to suppress fire by holding the system in hands or sprinkling the extinguishing agent directly into the fire. Do not use the system in any other way than described in this manual.

3 SYSTEM DESIGN LIMITATIONS

3.1 LPCB APPLICATIONS (FK-5-1-12 ONLY)

Each cylinder is limited to

- a single maximum volume of 2 m³.
- maximum single dimension of the enclosure 3 m (length, height or width)
- up to 4 BlazeTube runs connected to a single cylinder can be installed with each run protecting a maximum volume of 2 m³.
- a maximum BlazeTube length of 10 m from the valve to the end of any single BlazeTube run or 20 m for two outlet valves with loop configuration (*Example 3* in Chapter [3.2.3](#)).
- only vertical installation of the cylinder is allowed;
- the system shall display, monitor and provide a low-pressure alarm either as a stand-alone alarm unit or for connection to a fire control panel;
- the provision of an alarm which sounds in the event of system operation is required.*

* Implementation may not be necessary where, based on local risk assessments, warning devices may not be required such as remote and/or isolated applications.

The BlazeCut system is designed for protection of closed spaces from fire using volume or local fire suppression. It is not intended for use as a whole room or building fire protection system. This is based on the LPCB LPS 1666 requirements and test procedures for DLP fixed fire suppression systems.

3.2 VOLUME COVERAGE

Maximum volume coverage depends on two major factors: maximum ambient temperature in the protected enclosure and design concentration required. In [Table 4](#) and [Table 6](#) are listed most of standard applications for respective agent. For HFC-227ea and FK-5-1-12 the design concentration is to cover most of fixed applications with Class A and electrical fires classified by European standard EN 2. The design concentrations by volume are at ambient temperature 20 °C.

Table 4: Design concentrations of HFC-227ea

Class A Fires		6.7*	
Energized Electrical Fires <480 V		7.0*	
Energized Electrical Fires ≥480 V		12.0*	
Class B and C Fires			
1-Propane	10.0	Isopropanol	9.8
2-butoxyethanol	9.0	JP 4	9.0
Acetone	10.0	JP 5	9.0
Acetonitrile	7.0	Kerosene	9.6
Benzene	9.5	Methane	7.2
Commercial Heptane	8.7	Methanol	15.2
Commercial Hexanes	9.0	Methyl Ethyl Ketone	9.6
Crude Oil	8.5	Methyl Isobutyl Ketone	9.1
Cyclohexane	9.4	Methyl Tert-Butyl Ether	8.8
Cyclopentanone	9.6	n-Heptane	9.6
Denatured Alcohol	9.8	n-Pentane	8.8
Diesel fuel	8.7	Propane	8.7
Diethyl Ether	9.8	Pyrrolidine	9.5
Ethanol	12.6	Tetrahydrofuran	9.6
Ethyl Acetate	8.9	Toluene	7.6
Gasoline-87 Octane Unleaded	9.0	Transformer Oil	9.5
Hexene	7.6	1-Butane	8.6
Hydraulic Fluid	8.5	Xylene	7.8
Hydraulic Oils	7.7		

*Minimum design concentration according to NFPA 2001 (2022) and FM 4-9 (2018)

Table 5: Maximum volume coverage in m³ for HFC-227ea for different concentrations

Concentration:	6.7 %			7.0 %			9.0 %		
Temperature [°C]	1 kg	2 kg	4 kg	1 kg	2 kg	4 kg	1 kg	2 kg	4 kg
-20	1.63	3.26	6.51	1.55	3.11	6.21	1.18	2.36	4.73
-15	1.66	3.33	6.65	1.59	3.17	6.35	1.21	2.41	4.83
-10	1.69	3.38	6.77	1.61	3.23	6.46	1.23	2.46	4.91
-5	1.73	3.46	6.91	1.65	3.30	6.60	1.25	2.51	5.02
0	1.77	3.53	7.06	1.68	3.37	6.74	1.28	2.56	5.13
5	1.80	3.60	7.21	1.72	3.44	6.88	1.31	2.62	5.23
10	1.84	3.68	7.35	1.75	3.51	7.01	1.33	2.67	5.34
15	1.88	3.75	7.50	1.79	3.58	7.16	1.36	2.72	5.45
20	1.91	3.82	7.65	1.82	3.65	7.30	1.39	2.78	5.55
25	1.95	3.90	7.79	1.86	3.72	7.43	1.41	2.83	5.66
30	1.98	3.97	7.94	1.89	3.79	7.57	1.44	2.88	5.76
35	2.02	4.04	8.08	1.93	3.85	7.71	1.47	2.93	5.86
40	2.06	4.11	8.22	1.96	3.92	7.84	1.49	2.98	5.97
45	2.09	4.18	8.37	2.00	3.99	7.98	1.52	3.04	6.07
50	2.13	4.25	8.51	2.03	4.06	8.11	1.54	3.09	6.18
55	2.16	4.33	8.65	2.06	4.13	8.25	1.57	3.14	6.28

Table 6: Design concentrations of FK-5-1-12

Class A Fires		4.5*	
Energized Electrical Fires <480 V		4.5*	
Energized Electrical Fires ≥480 V		10.0*	
Class B and C Fires			
1-Butane	6.4	Isopropanol Alcohol	6.4
1-Propanol	7.0	Methane	7.3
2-butoxyethanol	6.8	Methanol	8.5
Acetone	5.6	Methyl Ethyl Ketone	5.9
Acetonitrile	4.2	Methyl Isobutyl Ketone	5.7
Commercial Heptane	5.7	Methyl Tert-Butyl Ether	6.0
Commercial Hexanes	5.6	n-Heptane	5.9
Cyclohexane	5.9	n-Pentane	6.1
Cyclopentanone	6.0	Propane	7.5
Denatured Alcohol	6.9	Pyrrolidine	6.1
Diesel fuel	4.4	Tetrahydrofuran	6.5
Diethyl Ether	6.4	Toluene	4.6
Ethanol	7.2	Transformer Oil	5.9
Ethyl Acetate	6.1	2,2,4-trimethylpentane	6.1
Gasoline-87 Octane Unleaded	5.9	Isooctane	6.1
Hexene	6.0		

*Minimum design concentration according to NFPA 2001 (2022) and FM 4-9 (2018)

NOTE:

For applications with different design concentration required use the BlazeCut Tool Calculator or contact the supplier of the system.

Table 7: Maximum volume coverage in m³ with 4.5 % design concentration for FK-5-1-12

Temperature [°C]	1.25 kg	2.5 kg	5 kg
-20	1.62	3.23	6.46
-15	1.65	3.30	6.61
-10	1.69	3.38	6.75
-5	1.73	3.45	6.90
0	1.76	3.52	7.05
5	1.80	3.60	7.19
10	1.83	3.67	7.34
15	1.87	3.74	7.48
20	1.91	3.81	7.63
25	1.94	3.89	7.77
30	1.98	3.96	7.92
35	2.02	4.03	8.06
40	2.05	4.11	8.21
45	2.09	4.18	8.36
50	2.13	4.25	8.50
55	2.16	4.32	8.65
60	2.20	4.40	8.79

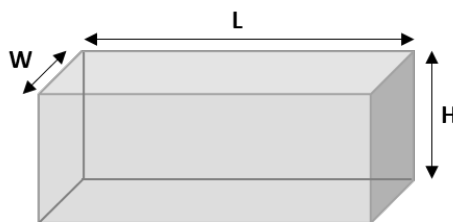

$$V = W * L * H \quad (1)$$

V – compartment volume [m³]

W – width [m]

L – length [m]

H – height [m]

3.2.1 CALCULATION OF REQUIRED AGENT

Determine the required agent quantity for hazard protection with the desired concentration. The agent amount is dependent on two major factors: lowest ambient temperature in the protected enclosure and design concentration required for the type of hazard.

$$S = k_1 + k_2 \times t \quad (2)$$

S – specific volume of the superheated agent vapor at 1 atmosphere and at temperature t [m³/kg]

t – minimum anticipated temperature of the protected volume [°C]

for HFC-227ea:

$k_1 = 0.1269$ $k_2 = 0.0005$

for FK-5-1-12:

$k_1 = 0.0664$ $k_2 = 0.0002741$

$$Q = \frac{V}{S} \times \frac{C}{100 - C} \quad (3)$$

Q – agent quantity [kg]

V – compartment volume [m³]

C – agent volumetric concentration at the given ambient temperature t [%]

Calculation example of required agent HFC-227ea:

Given values for an enclosure with Class A fire:

$V_t = 6.5 \text{ m}^3$ $t = 10 \text{ °C}$ $C = 6.7 \%$

$$Q = \frac{V_t}{S} \times \frac{C}{100 - C} = \frac{6.5}{0.1269 + 0.0005 \times 10} \times \frac{6.7}{100 - 6.7} = 3.54 \text{ kg}$$

Recommended system: CEA1xx-4-x

3.2.2 MAXIMUM VOLTAGE APPLICATION



BlazeCut recommends where the system is installed into applications above 480 V, a risk assessment must be completed and that the application is immediately de-energized via the use of a pressure switch.

Metal components (e.g., pressure gauge, fittings) shall be kept clear from the protected electrical equipment. Any BlazeCut system electrical components (e.g., pressure switch) in close vicinity to high voltage equipment shall be grounded. This must be carried out by a qualified electrical contractor.

AUTOMATIC FIRE SUPPRESSION SYSTEMS



Referencing below the NFPA 2001:2018 Standards Article 5.4.2.5.1 (Article 7.2.2.4.2 in 2022 revision)



The minimum design concentration for spaces containing energized electrical hazards supplied at greater than 480 volts that remain powered during and after discharge shall be determined by a hazard analysis and testing, as necessary.

For applications above 480 V, as each application is unique and requires a hazard analysis/risk assessment, the user/installer is responsible for any testing, if required.

Please contact BlazeCut for a copy of our hazard analysis/risk assessment form.

Referencing below FM Global Data sheet 4-9 (OCT 2018) Article 2.2.2.2.B

When the electrical equipment is not de-energized upon activation of the clean agent extinguishing system or has a time-delayed power disconnect, provide the minimum design concentration for an energized electrical fire (Class C – US classification) in accordance with Table 1 for the applicable equipment voltage. If the electrical equipment is not de-energized before the clean agent concentration falls below the minimum design value shown in Table 1 (Table 8), reignition is expected.



Table 8: Minimum Design Concentrations according to FM Global 4-9

Agent	Minimum Design Concentration, %			
	Class A	Class B ¹	Class C, <480 V	Class C, ≥480 V ^{2,3}
FK-5-1-12	4.5	5.9	4.5	10
HFC-125	9.7	11.3	9.0	20
HFC-227ea	6.7	8.7	7.0	12
HFC-23	18	19.5	20.3	Not tested ³
IG-01	38.0	52.5	42.8	Not tested ³
IG-55	37.9	39.1	42.7	Not tested ³
IG-100	37.2	43.7	41.9	Not tested ³
IG-541	34.2	40.6	38.5	57

¹ Class B values are for hydrocarbon fuels similar to n-Heptane. Class B minimum design concentrations will vary for other ignitable liquid fuels, based on the information provided in the manufacturer's design, installation, operation, and maintenance manual.

² These higher concentrations need to be reviewed for restrictions when used in normally occupied areas. See Section 3.2.4 and Table 5 for information regarding No Observed Adverse Effects Limit (NOAEL) and Lowest Observed Adverse Effects Limit (LOAEL).

³ FM Global conducted testing that indicates higher agent concentrations are needed for high-energy arcing faults. Only certain clean agents were tested. Refer to Section 3.3 for additional information on this testing. Where an agent is listed as "not tested," additional testing is necessary if the clean agent system is intended to protect energized electrical hazards greater than 480 volts that remain energized following discharge. Do not use an agent to protect high-energy electrical hazards if this testing has not been conducted.

IMPORTANT!

Please note the recommended increase gas concentration for Application higher than 480 V is by FM Global for Class C (US classification), Electrical applications. Please refer to FM Global for further information

3.2.3 DESIGN OF BLAZETUBE DETECTION

Maximum volume of protected enclosure by single system:

1. [Table 5](#) for HFC-227ea systems
2. [Table 7](#) for FK-5-1-12 systems
3. For custom agent concentrations use BlazeCut Design Calculator
4. 2 m³ for LPCB certified systems

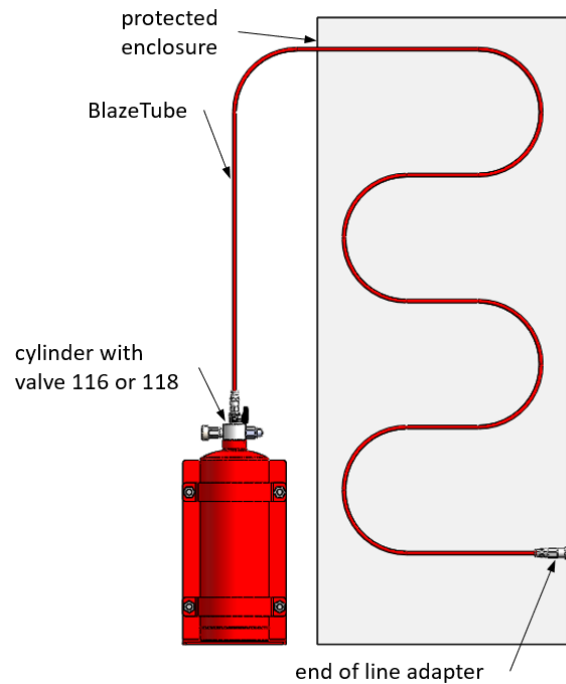

Example 1: one enclosure – system with the valve type 116 or 118

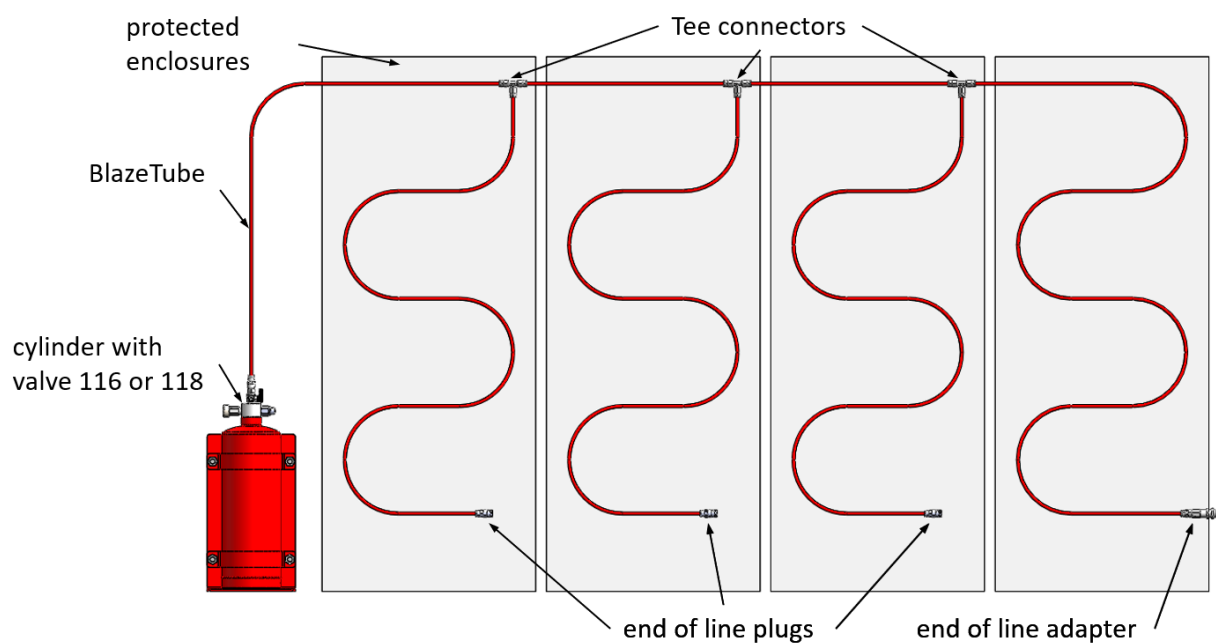

Example 2: multiple enclosures – system with the valve type 116 or 118; the detection tube is branched. It is suitable for installations with separate enclosures that are situated side by side.

With installation in Example 2 in case of fire and release of the extinguishing agent to one protected enclosure, the other enclosures remain unprotected.

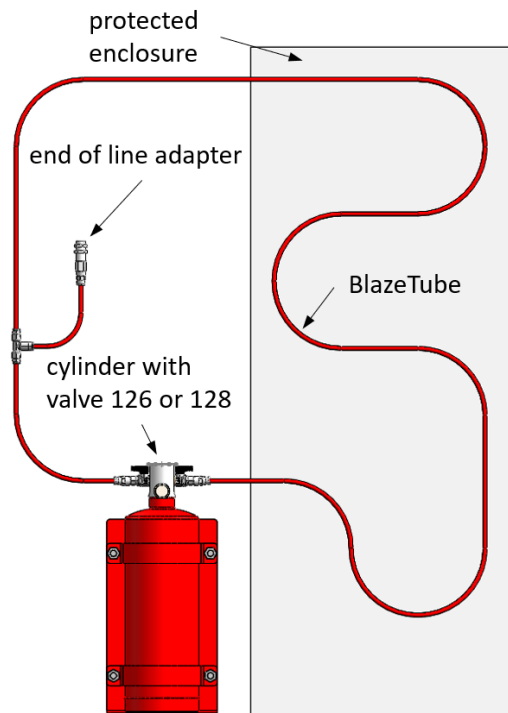

Example 3: one enclosure – system with the valve type 126 or 128 (valves with two outlets), the BlazeTube detection forms a „loop“. This method secures flow of the extinguishing agent to disruption point from two outlets which secures faster discharge of the extinguishing agent.

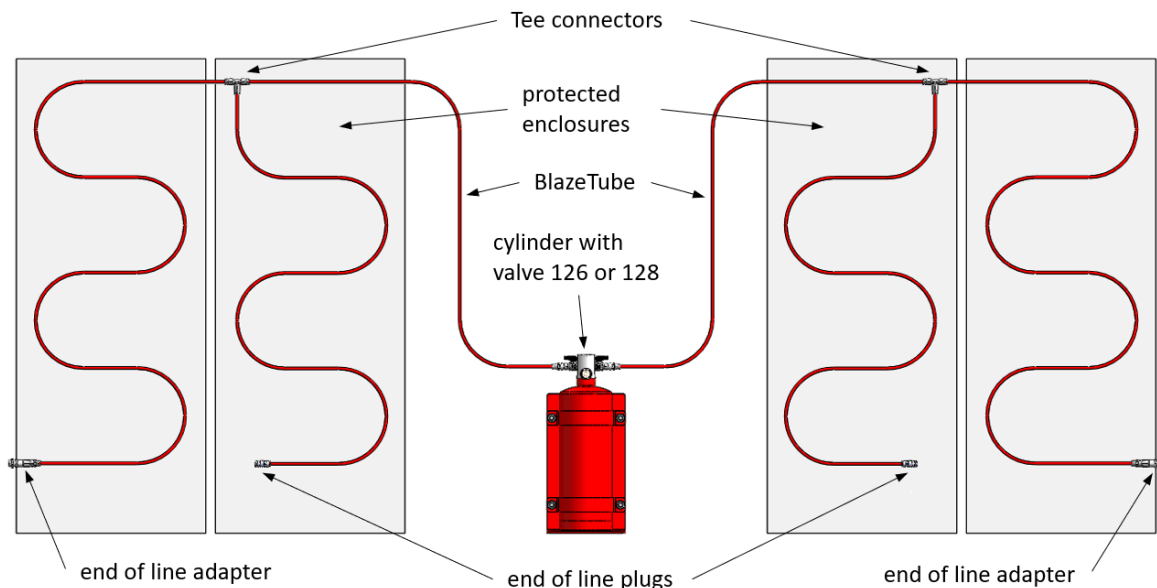

Example 4: multiple enclosures – system with the valve type 126 or 128 (valves with two outlets). It is suitable for installations with separate enclosures that are situated on two sides.

With installation in Example 4 in case of fire and release of the extinguishing agent to one protected enclosure, the other enclosures remain unprotected.

Method of installation consult with the supplier of BlazeCut system.

4 COMPONENTS OF THE SYSTEM AND THEIR DESCRIPTION

4.1 CYLINDERS FOR EXTINGUISHING AGENT

Depending on the system configuration and the necessary amount of the extinguishing agent, different size cylinders filled with the necessary amount of extinguishing agent may be used. The set size and selected parameters of normally used cylinders and valves are shown in pictures and [Table 9](#).

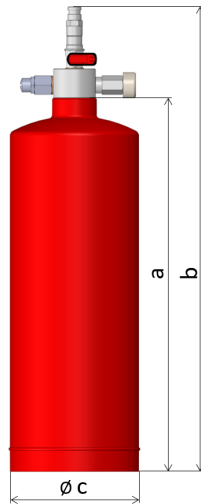

Cylinder with a valve 116 or 118

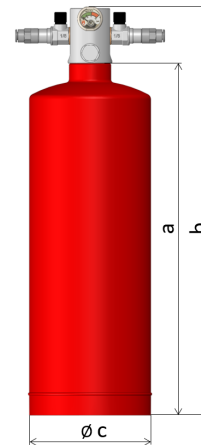

Cylinder with a valve 126 or 128

Table 9: Parameters and dimensions of cylinders including a cylinder valve

Cylinder volume [L]	Valve	a [mm]	b [mm]	Ø c [mm]	M* [kg]	Amount of agent [kg]
1.2	116	245	323	90	1.42	1 (HFC-227ea)
1.2	118	245	323	90	1.43	1.25 (FK-5-1-12)
2.4	116	319.5	397.5	110	1.90	2 (HFC-227ea) 2.5 (FK-5-1-12)
2.4	118	319.5	397.5	110	1.91	
2.4	126	319.5	369.5	110	2.18	
2.4	128	319.5	369.5	110	2.19	
5.0	116	348	426	150	2.85	4 (HFC-227ea) 5 (FK-5-1-12)
5.0	118	348	426	150	2.85	
5.0	126	348	398	150	3.12	
5.0	128	348	398	150	3.13	

*Weight of the empty cylinder with the valve and without the extinguishing agent, tolerance ± 0.05 kg

Table 10: Cylinders parameters

Parameter	Description
Certification	2014/68/EU
Material	steel DC04 EN10130
Surface treatment	high resistant powder coating
Neck ring	stainless steel 316L AISI/EN 1.4435/1.4404
Inside surface	polymer coating
Max. working pressure	PS 20 bar at 60 °C
Working temperature	-30 to +60 °C
Testing pressure	PT 30 bar
Colour	red RAL 3000



System model: CFK1xx
 System kit: CFK1xx-2.5-x
 Amount of agent: 2.5 kg
 Cylinder volume: 2.4 L
 Serial number: 0000001
 Production date: 01-2022

Cylinder label with model designation and production data

The cylinder is used for storage of extinguishing agent and expellant gas. The expellant gas is required to release the agent through the nozzle and also assists in the stabilization of pressure in the cylinder. Pressure in the cylinder will vary depending on the ambient temperature (see graph below). The amount of the extinguishing agent and its fill pressure are indicated on the label of the cylinder. Cylinders with HFC-227ea arrive **pressurized** as standard, while cylinders with FK-5-1-12 are **unpressurized** but can be delivered pressurized at customer's request.

4.1.1 SYSTEMS WITH EXTINGUISHING AGENT HFC-227EA USED – C(EA)(116, 118, 126, 128)

Extinguishing agent in the cylinder is in form of liquefied gas. The cylinder is pressurized with nitrogen gas under pressure of 12 bar at temperature 20 °C.

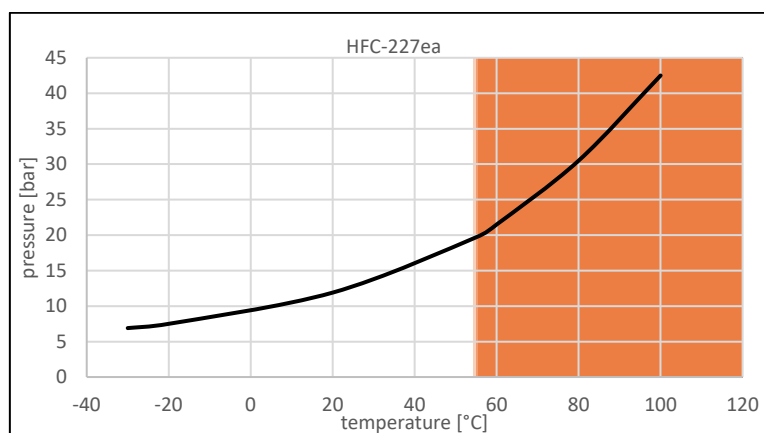

The relationship between temperature and pressure in the cylinder for HFC-227ea

Table 11: Values of pressure in the cylinder at given temperatures

Temperature [°C]	-20	-10	0	10	20	30	40	50	55
Pressure [bar]	8	8.5	9.2	10.4	12.0	13.3	15.3	18.1	20.0

4.1.2 SYSTEMS WITH EXTINGUISHING AGENT FK-5-1-12 USED – CFK (116, 118, 126, 128)

Extinguishing agent in the cylinder is in liquid form. The cylinder is pressurized with nitrogen gas under pressure of 15 bar at temperature 20 °C.

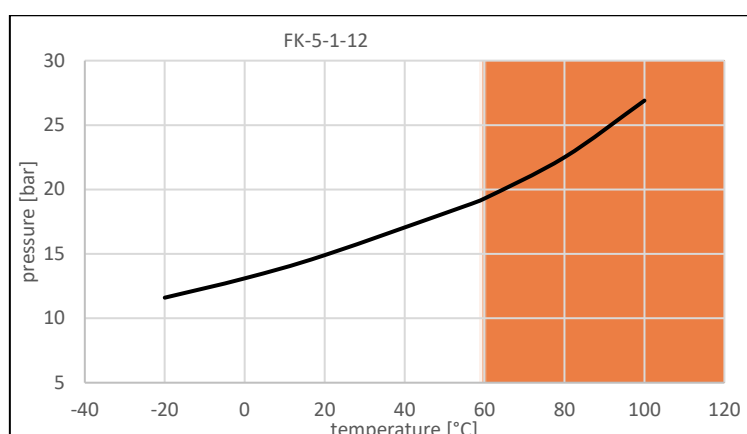

The relationship between temperature and pressure in the cylinder for FK-5-1-12

Table 12: Values of pressure in the cylinder at given temperatures

Temperature [°C]	-20	-10	0	10	20	30	40	50	60
Pressure [bar]	12	12.4	12.9	13.9	15.0	16.1	17.3	18.6	20.0

4.1.3 WARNINGS



In case of a significant difference between the actual pressure in the system with the data on the cylinder label, conduct an inspection of the system.



Do not install the cylinder, if an incorrect pressure is detected in the cylinder during inspection (i.e., pressure is significantly different from the values stated on the label).



The cylinder of the system is under constant pressure. Do not damage, puncture or throw the cylinder. During transfer or transport, secure the cylinder to avoid tipping, rolling, or rubbing against other objects or the ground. Do not mend or solder a damaged cylinder, it must be replaced.



During storage, separate empty cylinders from fully charged cylinders and appropriately label their storage area. Do not store or transport in the vicinity of strong sources of heat, aggressive chemical (caustic, corrosive) substances, prevent contact with sharp objects, vibrations or loading with other objects. Store in dry and well-ventilated rooms.



Do not expose the cylinder to extreme heat or direct sunlight if possible. Heating the surface of the cylinder may significantly increase pressure in the cylinder.



Always handle the cylinder as if it was under pressure, unless it is directly verified that it is completely empty (e.g., by pressing the Schrader valve in the M10x1 pressure gauge outlet on the cylinder valve; the value of the pressure on the pressure gauge may be incorrect or the pressure gauge may be malfunctioning).



Transportation of equipment under pressure by transportation vehicles is governed by specific legislation. Seek information and follow corresponding security requirements during transportation depending on the method of transport.

4.2 CYLINDER VALVES

The cylinder valve is assembled and is part of the charged cylinder when the BlazeCut system is supplied. The valve is closed by an external ball valve, which holds the pressure in the cylinder. The ball valve can be opened once the BlazeTube is installed and connected with the supplied end-of-line adapter or plug.

4.2.1 VALVES 116 AND 118 WITH ONE BLAZETUBE OUTLET Ø 6 OR Ø 8 MM

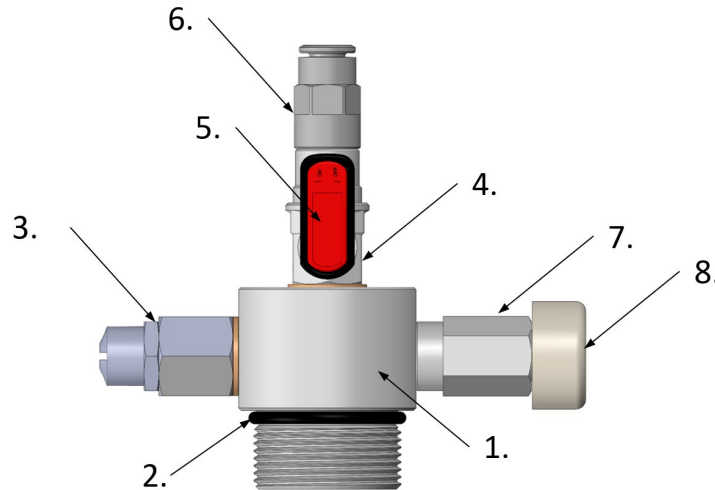

Side view of the cylinder valve 116, 118 and connecting components

1. Body of the cylinder valve 116, 118
2. O-ring seal of the cylinder valve
3. G1/8" outlet with a pressure relief valve APR001 and a bonded seal FVG002
4. G1/8" agent discharge outlet with a ball valve ABV001 and a bonded seal FVG002
5. Removable lever of the ball valve
6. BlazeTube outlet connector FBT1BP026 (valve 116) or FBT1BP028 (valve 118) for the BlazeTube detection
7. G1/8" outlet with a valve adaptor FVABM0210 (G1/8" to M10x1) – comes with pre-installed pressure gauge 8. as standard
8. Pressure gauge APG001 (for HFC-227ea) or APG002 (for FK-5-1-12) with an O-ring, thread M10x1

4.2.2 WARNINGS



Prevent the cylinder valve from damage and impact. Do not lift the cylinder holding it by the cylinder valve or by other components connected to the valve. Always store and transport cylinders with the valve facing upwards.



Do not try to remove the cylinder valve if the cylinder is under pressure. Prevent the cylinder valve from damage and impact. Do not lift the cylinder by holding it by the cylinder valve or by other components of the system. Always store and transport cylinders with the valve facing upwards.



The valve is mounted on the cylinder by a specific tightening torque. Do not tighten or release the valve. If leak is detected on the connector of the valve and the cylinder join, the charged cylinder cannot be used.

Table 13: Parameters of valves 116 and 118

Valve type	Total valve height	Valve height w/o the cylinder thread	Cylinder thread	Dip tube thread	Pressure gauge thread	BlazeTube Detection outlet	Ball valve outlet
116	94 mm	78 mm	M30x1.5	M16x1.5	M10x1	Ø 6 mm	G1/8"
118	99 mm	78 mm	M30x1.5	M16x1.5	M10x1	Ø 8 mm	G1/8"

4.2.3 BLAZETUBE DETECTION OUTLET

The BlazeTube connector with $\varnothing 6$ (valve 116) or $\varnothing 8$ mm (valve 118) outlet is coupled with a small ball valve mounted on the top valve outlet with a thread G1/8". The ball valve is closed when supplied and must only be opened after pressurization of the BlazeTube detection, for the system to become fully functional.

For safety reasons cylinders under pressure must be protected against accidental activation by removal of the lever of the ball valve during transportation of the cylinder. Install the lever when required during installation of the BlazeTube detection by using the supplied parts – lever body, lever cover, screw. During the installation of the ball valve lever, follow the steps listed below. To uninstall the ball valve lever, remove the red cover by pushing its pin on the back and follow the steps in reverse to the installation.

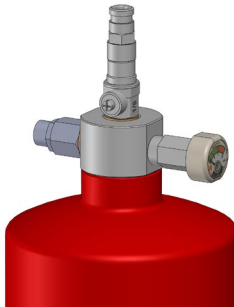

Ball valve without a lever

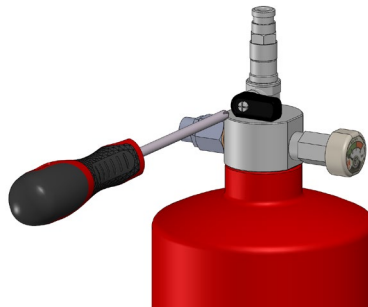

Use a screwdriver for mounting

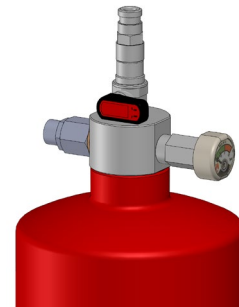

Place the red cover on the lever

4.2.4 WARNINGS



Do not try to remove the BlazeTube detection ball valve connector from the cylinder valve if the system is under pressure. This will cause the cylinder valve to activate and discharge the agent.



Always remove the lever of the ball valve during transportation of cylinders which are under pressure.



Do not open the ball valve of the BlazeTube detection outlet connector before the installation and pressurization of the BlazeTube, the extinguishing agent will be released. Protect the ball valve from accidental opening during transportation and handling of the cylinder. Follow the instructions for transportation of the cylinder.

The ball valve of the BlazeTube detection outlet connector can only be opened after completing the following:



- the cylinder of the system is properly fastened,
- the system is completely installed,
- the BlazeTube detection is properly connected to the valve and to the end-of-line adapter,
- the end-of-line adapter is properly mounted and secured with a P-clamp,
- the BlazeTube detection is pressurized to 1 bar above the current cylinder pressure.

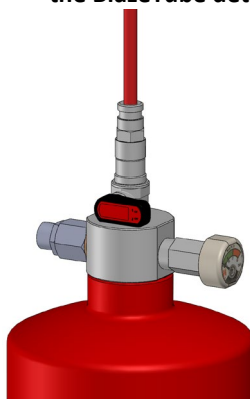

Ball valve is closed

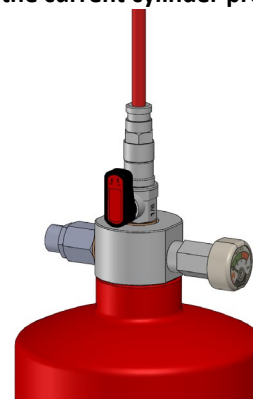

Ball valve is open

To prevent unintentional switch of the ball valve lever to closed position, install the ball valve anti tamper safety lock ABL001 and a plastic lock seal ALS001.

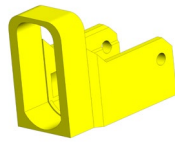

Ball valve anti tamper safety lock ABL001

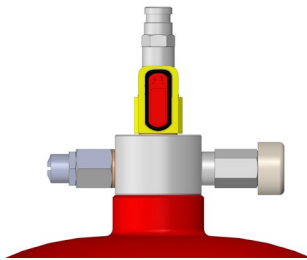

Installed ball valve anti tamper safety lock

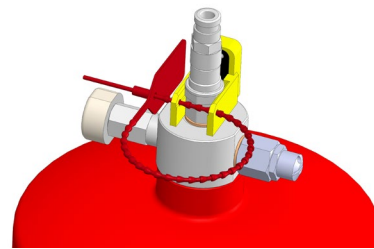

Installed plastic lock seal

Put the ball valve anti tamper safety lock in position so that the front face of it and the front face of the ball valve lever are in plane. To secure the ball valve anti tamper safety lock, insert a plastic lock seal through the two holes on the ball valve anti tamper safety lock. Fasten the lock seal tightly.

4.2.5 VALVE 126 AND 128 WITH TWO BLAZETUBE DETECTIONS Ø 6 OR Ø 8 MM

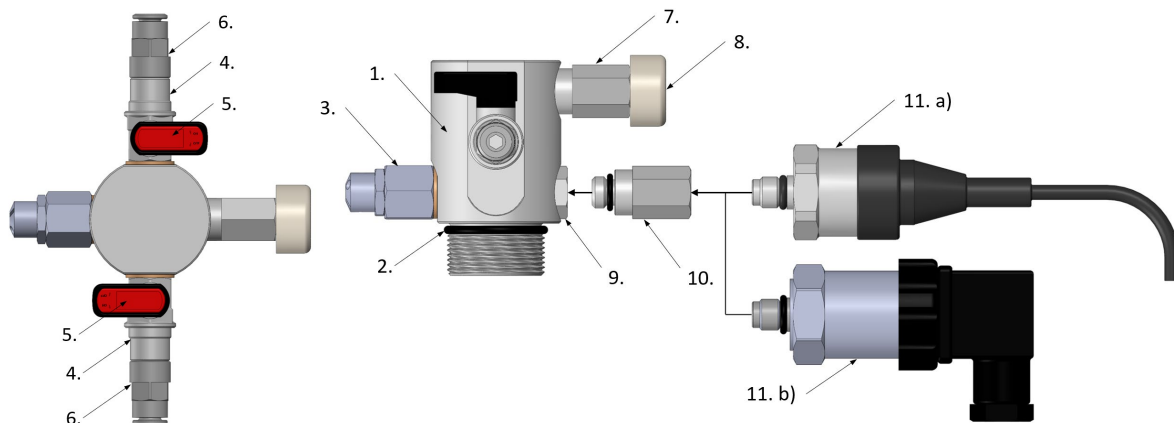

Top (left) and side view (right) of the cylinder valve 126, 128 and connecting components

1. Body of the cylinder valve 126, 128
2. O-ring seal of the cylinder valve
3. G1/8" outlet with a pressure relief valve APR001 and a bonded seal FVG002
4. G1/8" agent discharge outlet with a ball valve ABV001 and a bonded seal FVG002
5. Removable lever of the ball valve
6. BlazeTube outlet connector FBT1BP026 (valve 126) or FBT1BP028 (valve 128)
7. G1/8" outlet with a valve adaptor FVABM0210 (G1/8" to M10x1) – comes with pre-installed pressure gauge 8. as standard
8. Pressure gauge APG001 (for HFC-227ea) or APG002 (for FK-5-1-12) with an O-ring, thread M10x1
9. G1/8" outlet with a sealing plug FVP1B02 with an O-ring; can be replaced with an adaptor FVABM0210
10. (G1/8" to M10x1) for use with 11. a) or 11. b)
11. G1/8" to M10x1 adaptor FVABM0210 – optional component
11. Pressure monitoring components
 - a) Pressure Transducer ATA100
 - b) Pressure Switch APS001

NOTE:

The adaptor FVABM0210 for the outlet 9. has to be installed at the factory before pressurization of the cylinder.

Table 14: Parameters of the valves 126 and 128

Valve type	Total valve height	Height of the valve without the cylinder thread	Cylinder thread	Dip tube thread	Pressure gauge thread	BlazeTube Detection outlet	Ball valve outlet
126	66 mm	50 mm	M30x1.5	M16x1.5	M10x1	2 x Ø 6 mm	2 x G1/8"
128	66 mm	50 mm	M30x1.5	M16x1.5	M10x1	2 x Ø 8 mm	2 x G1/8"

4.2.6 BLAZETUBE DETECTION OUTLET

The BlazeTube connectors with Ø 6 (valve 126) or Ø 8 mm (valve 128) outlets are coupled with a small ball valve mounted on the side valve outlets with a thread G1/8". The ball valves are closed when supplied and must only be opened after pressurization of the BlazeTube detection, for the system to become fully functional.

For safety reasons cylinders under pressure must be protected against accidental activation by removal of the lever of the ball valve during transportation of the cylinder. Install the lever during installation of the BlazeTube detection by using the supplied parts – lever body, lever cover, screw. During installation proceed as shown on the figures below. To uninstall the valve, pray off the red cover with a flathead screwdriver and follow the steps backwards of installation.

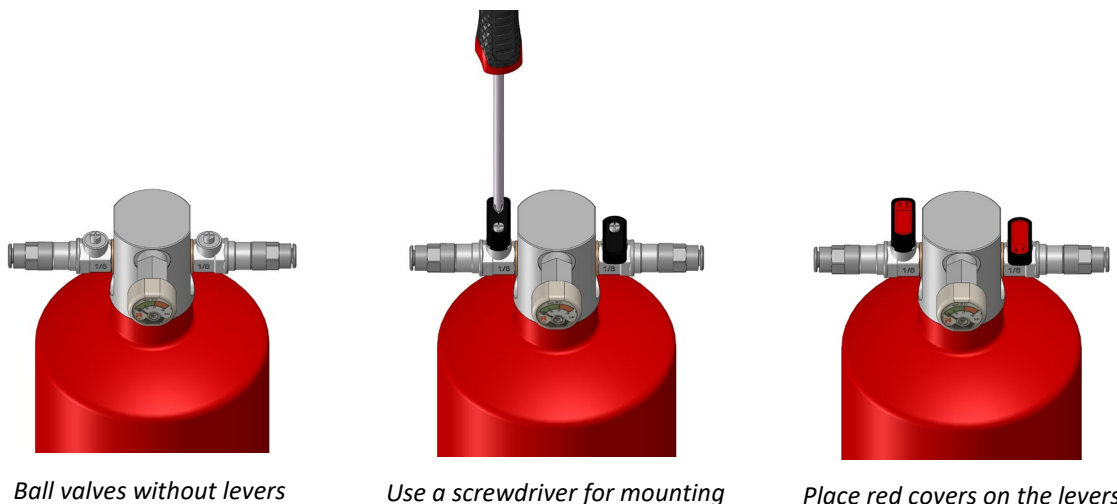

4.2.7 WARNINGS



Do not try to remove the BlazeTube detection ball valve connector from the cylinder valve if the system is under pressure. This will cause the cylinder valve to activate and discharge the agent.



Always remove the lever of the ball valve during transportation of cylinders which are under pressure.



Do not open the ball valve of the BlazeTube detection outlet connector before the installation and pressurization of the BlazeTube, the extinguishing agent will be released. Protect the ball valve from accidental opening during transportation and handling of the cylinder. Follow the instructions for transportation of the cylinder.

The ball valve of the BlazeTube detection connector can only be opened after completing the following:



- the cylinder of the system is properly fastened,
- the system is completely installed,
- the BlazeTube detection is properly connected on the valve and to the end-of-line adapter,
- the end-of-line adapter is properly mounted and secured with a P-clamp,
- the BlazeTube detection is pressurized to 1 bar above the current cylinder pressure,
- if using only one BlazeTube detection on a 126 or 128 valve, unused outlet must be sealed by a valve plug (see Chapter [7.3.1](#)).

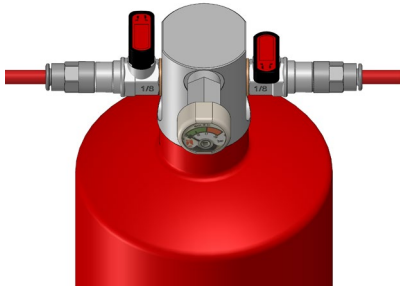

Ball valves are closed

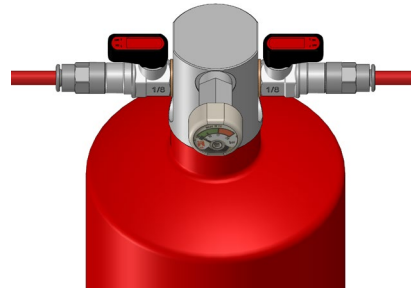

Ball valves are open

To prevent unintentional switch of the ball valve lever to closed position, install the ball valve anti tamper safety lock ABL001 and a plastic lock seal ALS001.

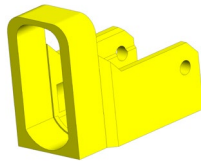

Ball valve anti tamper safety lock ABL001

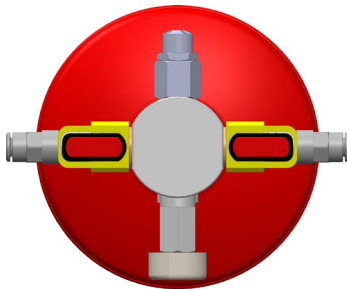

Installed ball valve anti tamper safety locks

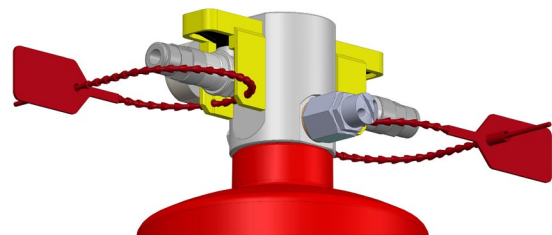

Installed plastic lock seal

Put the ball valve anti tamper safety lock in position so that the front face of it and the front face of the ball valve lever are in plane. To secure the ball valve anti tamper safety lock, insert a plastic lock seal through the two holes on the ball valve anti tamper safety lock. Fasten the lock seal tightly.

4.3 BLAZETUBE DETECTION

The BlazeTube detection is a linear indicator of fire and also distribution tube for application of the agent into the protected enclosure. During installation, the tube is pressurized with nitrogen gas and during operation of the system it is under constant pressure. Pressure in the tube and in the cylinder is the same during the operation of the system. During fire, the BlazeTube detection degrades by direct effect of fire or high temperature at any place whereby disrupting the BlazeTube in the place of direct effect of fire or the highest temperature and releasing entire content of the cylinder through the created “nozzle”. This system is independent of any electrical supply and operates solely on physical principles.

The time taken to cause the rupture of the BlazeTube detection may vary and depends on the pressure in the tube, which is affected by the level of pressurization in the system and ambient temperature. The higher the pressure in the BlazeTube detection, the sooner the BlazeTube detection ruptures and activates the system.

Table 15: BlazeTube detection parameters

Parameter	Property
material	special heat sensitive plastic
colour	red (RAL3000)
outside diameter	6 mm or 8 mm
operating temperature	-30 °C to +110 °C
activation temperature	about 170 °C
life span	up to 10 years



BlazeTube Detection

Table 16: Compatibility with selected common chemicals

Name	Status	Name	Status
Sodium Hydroxide, 35 %	OK	Standard fuel with alcohol	OK
Ammonium Hydroxide, 10 %	OK	Standard fuel without alcohol	OK
Isopropyl alcohol	OK	Sodium Carbonate, 20 %	OK
Ethanol	OK	Sodium Hypochlorite, 10 %	OK
Methanol	OK	Sodium Chloride, 10 %	OK
Diethyl ether	OK	Zinc Chloride, 50 %	OK
Acetone	OK	Citric Acid, 10 %	OK
Toluene	OK	Acetic Acid, 5 %	OK
Hexane	OK	Sulfuric Acid, 38 %	OK
iso-Octane	OK	Lactic Acid, 10 %	OK
Insulating Oil	OK	Ethylene Glycol in water, 50 %	OK
Multi-grade motor oil	OK	Hydrogen peroxide	OK
Hypoid gear oil	OK	Ethyl Acetate	OK
Diesel fuel	OK	Water	OK

Table 17: Types of BlazeTube detection

Part №	Description
ABT170	6 mm BlazeTube detection suits to valve type 116, 126
ABT170-8	8 mm BlazeTube detection suits to valve type 118, 128

Table 18: BlazeTube detection standard kits

Part №	Description
KABT170-005	∅ 6 mm BlazeTube 5 metres, cable gland ACG112, 20 cable ties ACT314, 2 labels ALA018
KABT170-010	∅ 6 mm BlazeTube 10 metres, cable gland ACG112, 40 cable ties ACT314, 4 labels ALA018
KABT170-015	∅ 6 mm BlazeTube 15 metres, cable gland ACG112, 60 cable ties ACT314, 6 labels ALA018
KABT170-020	∅ 6 mm BlazeTube 20 metres, cable gland ACG112, 80 cable ties ACT314, 8 labels ALA018
KABT170-030	∅ 6 mm BlazeTube 30 metres, cable gland ACG112, 120 cable ties ACT314, 12 labels ALA018
KABT170-040	∅ 6 mm BlazeTube 40 metres, cable gland ACG112, 160 cable ties ACT314, 16 labels ALA018

Table 19: BlazeTube detection heavy-duty kits

Part №	Description
KABT170-005-HD	∅ 6 mm BlazeTube 5 metres, cable gland ACG112, 10 P-clamps APC020, 10 grommets AGBT005, 2 labels ALA018
KABT170-010-HD	∅ 6 mm BlazeTube 10 metres, cable gland ACG112, 10 P-clamps APC020, 20 grommets AGBT005, 4 labels ALA018
KABT170-015-HD	∅ 6 mm BlazeTube 15 metres, cable gland ACG112, 10 P-clamps APC020, 30 grommets AGBT005, 6 labels ALA018
KABT170-020-HD	∅ 6 mm BlazeTube 20 metres, cable gland ACG112, 10 P-clamps APC020, 40 grommets AGBT005, 8 labels ALA018
KABT170-030-HD	∅ 6 mm BlazeTube 30 metres, cable gland ACG112, 10 P-clamps APC020, 60 grommets AGBT005, 12 labels ALA018
KABT170-040-HD	∅ 6 mm BlazeTube 40 metres, cable gland ACG112, 10 P-clamps APC020, 80 grommets AGBT005, 16 labels ALA018



BlazeTube detection standard kit



BlazeTube detection heavy duty kit

4.4 PRESSURE GAUGES

Actual pressure in the cylinder can be determined by reading the value on the pressure gauge, which is mounted on the cylinder valve, alternatively an additional gauge on the end-of-line adapter. Green zone of the pressure gauge indicates the permissible pressure in the system.

Table 20: Types of pressure gauges

Part No	Description	Pressure range	Thread	Material
APG001	for HFC-227ea agent	green zone: 8 – 20 bar red zones: 0 – 8 bar, 20 – 28 bar	M10x1	body: nickel plated brass O-ring: EPDM
APG002	for FK-5-1-12 agent	green zone: 12 – 20 bar red zones: 0 – 12 bar, 20 – 28 bar	M10x1	body: nickel plated brass O-ring: EPDM



Pressure gauge APG001



Pressure gauge APG002

When the system is supplied, the pressure gauge is mounted on the cylinder valve via an adapter FVABM0210 (G1/8" to M10x1). It is always recommended to keep the pressure gauge located in the same position as it was supplied. If there is a need for the pressure gauge relocation, follow instructions in Chapter [A2.1.1](#).

Always place the pressure gauge so that the value of pressure can be read easily.



If the system is in operation and the BlazeTube detection under pressure, the ball valve on the cylinder valve must be closed, when mounting and dismantling the pressure gauge at the end-of-line device.

4.5 BLAZETUBE PUSH-IN CONNECTORS

BlazeCut double seal push-in connectors provide a double tight connection on the BlazeTube, thus ensuring a highly reliable connection and avoiding possible leakage that may occur. Connection and disconnection of the tube can be repeated several times without the use of proper tools and without compromising the performance of the fitting and the sealing around the tube.

The BlazeTube detection can be connected through Tee, elbow or straight push-in connectors. It is recommended to minimise the use of BlazeTube connectors and install them low in the main fire risk areas to avoid high temperatures during the operation of the equipment. In fire risk areas with high temperatures like engine compartments it is recommended to install the BlazeTube detection in whole length and refrain from using BlazeTube fittings in the heated areas.

Table 21: BlazeTube push-in connectors

Part №	Description	Working temperature	Working pressure	Material
FBT1PP66	straight connector for BlazeTube Ø 6 mm, NBR	-20 to +80 °C	0.9 – 60 bar	body and gripper: nickel-plated brass seals: NBR or EPDM
FBT1PP88	straight connector for BlazeTube Ø 8 mm, NBR			
FBT3PPP666	Tee connector for BlazeTube Ø 6 mm, NBR			
FBT3PPP888	Tee connector for BlazeTube Ø 8 mm, NBR			
FBT1BP026	outlet connector for BlazeTube Ø 6mm, G1/8", EPDM	-30 to +80 °C		
FBT1BP028	outlet connector for BlazeTube Ø 8mm, G1/8", EPDM			



FBT1PP66, FBT1PP88



FBT1BP026, FBT1BP028



FBT3PPP666, FBT3PPP888

4.6 BLAZETUBE END-OF-LINE DEVICES

Table 22: List of end-of-line devices

Part №	Description
FBT1P6	End-of-line plug Ø 6 mm
FBT1P8	End-of-line plug Ø 8 mm
AEA006	End-of-line adapter Ø 6 mm with standard push-in connector for BlazeTube
AEA008	End-of-line adapter Ø 8 mm with standard push-in connector for BlazeTube

4.6.1 END-OF-LINE PLUGS

End-of-line plugs are used to close one BlazeTube detection in installations with two BlazeTube detections (valve types 126 and 128) or when branching the BlazeTube.

Table 23: Types of end-of-line plugs

Part №	Description	Working temperature	Working pressure	Material
FBT1P6	End-of-line plug Ø 6 mm	-30 to +80 °C	0.9 – 60 bar	body and gripper: nickel-plated brass seals: EPDM
FBT1P8	End-of-line plug Ø 8 mm	-30 to +80 °C		



FBT1P6, FBT1P8

4.6.2 END-OF-LINE ADAPTERS

BlazeTube end-of-line adapter is used for pressurization of the BlazeTube detection system when the system is installed (see Chapter 7.4) and for pressurization of the system during inspection (see Chapter 8.3).

IMPORTANT!

The end of the adapter with internal thread M10x1 must be occupied by a pressure gauge, Pressure Switch APS001 or Pressure Transducer ATA100, to protect the Shrader valve inside.

Table 24: Types of end-of-line adapters

Part №	Description	Working temperature	Working pressure	Material
AEA006	End-of-line adapter \varnothing 6 mm	-30 to +80 °C	0.9 – 60 bar	body and gripper: nickel-plated brass seals: EPDM
AEA008	End-of-line adapter \varnothing 8 mm			

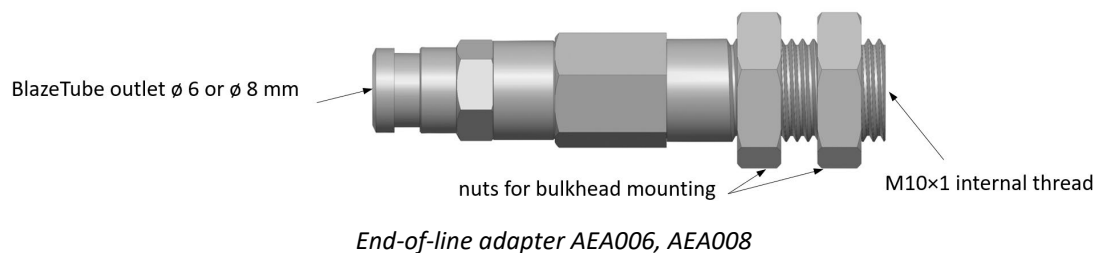

Table 25: End-of-line adapter components

Part №	Description	Material
ANE001	spare nut for end-of-line adapter AEA006 and AEA008, M14x1.5	galvanized steel



ANE001

4.7 FASTENING MATERIAL

Linear parts of BlazeCut system (BlazeTube detection, electrical cables) must be tightly fastened and secured against movement. Use enclosed connecting material if necessary. It is possible to use other suitable fastening systems if they provide secure mounting of the components and are suitable for the environment (high temperatures etc.). Avoid damaging the components when fastening. Follow the instructions in this manual when fastening.

4.7.1 P-CLAMPS AND FASTENERS

BlazeCut system kits are supplied with various P-clamps suitable for firm fastening of the BlazeCut components.

Table 26: P-clamps

Part №	Description	Material
APC006	6 mm – suits 6 mm BlazeTube detection	galvanized steel, rubber insert
APC008	8 mm – suits 8 mm BlazeTube detection	galvanized steel, rubber insert
APC010	10 mm – suits spiral ABTS006	galvanized steel, rubber insert
APC012	12 mm – suits spiral ABTS008, all push-in connectors for \varnothing 6 BlazeTube	galvanized steel, rubber insert
APC014	14 mm – suits end-of-line plug FBT1P6, all push-in connectors for \varnothing 8 BlazeTube, end-of-line adapters AEA006 and AEA008	galvanized steel, rubber insert
APC016	16 mm – suits end-of-line plug FBT1P8	galvanized steel, rubber insert
APC020	20 mm – suits grommets	stainless steel, PVC cover

Table 27: Through panel fasteners

Part No	Description	Material
ACG112	cable gland with locknut, for detection tube, 12 mm steel tube and electrical cable, 18.5 mm hole for mounting	polyamide



P-clamp APC006 - APC016



P-clamp APC020



Cable gland ACG112

4.7.2 PROTECTIVE SPIRALS AND BRAIDS FOR THE BLAZETUBE DETECTION

In case of installation in enclosures with increased risk of mechanical damage part of the BlazeTube detection exposed to higher risk of mechanical damage can be installed in the protective spiral or braid. Slot the BlazeTube detection into the protective spiral or braid before installation.



Do not use the protective spiral or braid on the BlazeTube detection in the main fire risk area as it could affect discharge of the extinguishing agent from the BlazeTube detection.

IMPORTANT!

Always ensure the cut ends of the spiral do not turn inward towards the BlazeTube, this will avoid scratches and damage to the BlazeTube.

Table 28: Types of protective spirals and braids

Part No	Description	Material	Length
ABTS006-005	protective spiral for \varnothing 6 mm BlazeTube detection	stainless steel	5 m
ABTS006-010		stainless steel	10 m
ABTS008-005	protective spiral for \varnothing 8 mm BlazeTube detection	stainless steel	5 m
ABTS008-010		stainless steel	10 m
ABTB006-005	protective braid for \varnothing 6 mm and \varnothing 8 mm BlazeTube, from -55 °C to 180 °C	polyamide	5 m
ABTB006-010		polyamide	10 m



Protective spiral



Protective spiral with BlazeTube



Protective spiral kit



Protective braid

Table 29: Protective spiral kits

Part No	Description
KABTS006-005	for Ø 6 mm BlazeTube, 5 metres protective spiral ABTS006, 10 P-clamps APC010
KABTS006-010	for Ø 6 mm BlazeTube, 10 metres protective spiral ABTS006, 20 P-clamps APC010
KABTS008-005	for Ø 8 mm BlazeTube, 5 metres protective spiral ABTS008, 10 P-clamps APC010
KABTS008-010	for Ø 8 mm BlazeTube, 10 metres protective spiral ABTS008, 20 P-clamps APC010

4.7.3 BLAZETUBE GROMMETS

For installation of the BlazeTube (ABT170 only) in harsh environments use silicone grommets and plastic-coated P-clamps APC020. Maximum recommended distance between the clamps is 500 mm.

Table 30: Grommet and cable ties

Part No	Description	Material
AGT005	grommet with 5 mm hole – suits BlazeTube	silicone
ACT314	cable tie with increased heat resistance up to +125 °C, 3.6 x 140 mm, black	plastic
ACT528	cable tie with increased heat resistance up to +125 °C, 5 x 280 mm, black	plastic



BlazeTube ABT170 in the APC020 clamp and AGT005 grommet



Cable tie



Never use cable ties for installation of BlazeTube in engine compartment or other installations with high ambient temperature. Always use suitable hose clamps.

4.8 LABELS

Various high-quality UV stabilized labels are supplied with the BlazeCut system to ensure that the operator or people that may come in contact with the system are informed about its presence and operation. All labels can be reordered separately when replacement is required due to damage.

Table 31: Notification labels

Part No	Description	Comment
ALA002	"Shutdown Equipment"	label for use with the Pressure switch and a relay, 100 x 70 mm
ALA008	General warning	Label for DLP systems 100 x 70 mm
ALA018	"Caution fire detection"	label for BlazeTube, 135 x 25 mm
ALA019	"Fire Alarm"	label for the buzzer AWB001, Ø 53 mm
ABS110	"BlazeCut"	promotional sticker, 110 x 68 mm
ABS220	"BlazeCut"	promotional sticker, 220 x 135 mm
ABS300	"BlazeCut"	promotional sticker AFSS, 300 x 110 mm

AUTOMATIC FIRE SUPPRESSION SYSTEMS



ALA002



ALA008



ALA018



ALA019



ABS110 and ABS220



ABS300

Table 32: Cylinder label types

Part No	Agent	Cylinder size
ALA020	HFC-227ea	1.2 L, 2.4 L
ALA021	HFC-227ea	5.0 L
ALA029	FK-5-1-12	1.2 L, 2.4 L
ALA030	FK-5-1-12	5.0 L

BLAZECUT FIRE SUPPRESSION SYSTEM

CLEAN AGENT

CE 1354

Technical Specification
 Type of agent: HFC-227ea
 Allowed operation temperature: -20°C up to +55°C
 Operation pressure at 20°C: 12 bar
 Charged with: Nitrogen (N₂)

Instructions for installation, maintenance and inspection

- The system may be installed, maintained and inspected by persons trained or authorized by BlazeCut.
- Installation, maintenance and inspection must be performed in accordance with instructions in the BlazeCut Installation and Service Manuals.
- Inspection of the system must be performed at least once in 12 months.
- Inspection of the system condition must be performed according to local legislation and statutory requirements.
- Install and maintain the system with BlazeCut components. The use of components not approved by the manufacturer will void the warranty, and may cause malfunction of the system, threatening the safety and health of people.

Warnings:

- The system is under constant pressure; any mechanical interference is prohibited.
- Interference with the system may cause malfunction of the system and presents danger to safety and health of people.
- Do not use the system as a portable fire extinguisher! It can present danger to the safety and health of people.
- Contains gas under pressure; may explode if heated.

Attention:

Always consult suitability of use of the system and type of extinguishing agent in specific conditions with the manufacturer.

Contains fluorinated greenhouse gases. Chemical name: 1,1,1,1,2,3,3,3-heptafluoropropane (HFC-227ea)

Cylinder labels identifying type of extinguishing agent and basic information and instructions about the system.

5 DEFINITION OF LEGAL REQUIREMENTS



After the BlazeCut System is installed the cylinder, valve and BlazeTube detection is under constant pressure. The activities of installation of the system, its activation, operation, repair and maintenance may be governed by specific legislation. These activities may need to be performed only by persons with professional qualifications. Activation and operation of the equipment under pressure may also be governed by specific legislation.



Always observe local legislation and statutory requirements.



BlazeCut systems CEA(116, 118, 126, 128) contain clean extinguishing agent HFC-227ea which is a fluorinated greenhouse gas. Installation of the system, its activation, operation and repair and maintenance are governed by specific legislation and these activities may be performed only by persons with professional qualification. Operation of the system is also governed by specific legislation and is subject to inspections for gas leak. Always observe local legislation and statutory requirements.

6 INFORMATION ON EXTINGUISHING AGENTS USED

Systems BlazeCut CEA(116, 118, 126, 128) uses extinguishing agent:

- HFC-227ea; chemical name: 1,1,1,2,3,3,3-Heptafluoropropane. It is halogen derivative of hydrocarbons. It is liquefied hydrocarbon gas, colourless and odourless. GWP: 3220

Systems BlazeCut CFK(116, 118, 126, 128) uses extinguishing agent:

- FK-5-1-12, chemical name: Perfluoro (2-Methyl-3-Pentanone). It is a fluorinated ketone, synthetically made agent. In normal conditions it is a non-conductive clear liquid with a slight odour.

6.1 DESCRIPTION OF HFC-227EA

The extinguishing agent is clean extinguishing medium, used in BlazeCut system for volume or local fire suppression. Extinguishing effects are due to cooling and anticatalyst effect. Extinguishing agent siphons heat from fire, enters the chain chemical reaction of burning, slows this reaction and stops it.

Extinguishing agent is not toxic or poisonous, it does not have carcinogenic or mutagenic effects and it is considered environmentally accepted substitute for halon extinguishing agents harmful to the environment used in the past.

With volume fire suppression the efficiency of the system depends mainly on extinguishing concentration, which should be reached in the area of fire. Desired extinguishing concentration with HFC-227ea is lower than concentration dangerous to people.

6.1.1 MAIN ADVANTAGES OF THE EXTINGUISHING AGENT

- electrically non-conductive
- non-corrosive
- resistant to temperature changes
- safe for people when safety instructions are followed
- leaves no residue
- does not damage equipment, objects or sensitive devices
- zero ozone depletion potential (ODP – Ozone Depletion Potential)

6.2 DESCRIPTION OF FK-5-1-12

The extinguishing agent is clean extinguishing medium, used in BlazeCut system for volume fire suppression. Extinguishing effects are due to cooling and anticatalyst effect. Extinguishing agent siphons heat from fire, enters the chain chemical reaction of burning, slows this reaction and stops it. Extinguishing agent is not toxic or poisonous, it does not have carcinogenic or mutagenic effects.

FK-5-1-12 is an ecological alternative and it is considered to be a next generation substitution of halon agents used in the past. Compare to chemical extinguishing substances used today (like HFC gases) FK-5-1-12 has at the moment lowest global warming potential (GWP = 1), lowest atmospheric lifetime (5 days) and zero ozone depletion potential (ODP = 0). These unique environmental features promise to FK-5-1-12 its long-term use in the future.

With volume fire suppression the efficiency of the system depends mainly on extinguishing concentration, which should be reached in the area of fire. Desired extinguishing concentration with FK-5-1-12 is lower than concentration dangerous to people.

6.2.1 MAIN ADVANTAGES OF THE EXTINGUISHING AGENT

- electrically non-conductive
- non-corrosive
- resistant to temperature changes
- safe for people when safety instructions are followed
- leaves no residue
- does not damage equipment, objects or sensitive devices
- zero ozone depletion potential (ODP – Ozone Depletion Potential)
- almost zero global warming potential (GWP – Global Warming Potential)

6.3 PERMISSIBLE USES OF EXTINGUISHING AGENTS

Both HFC-227ea and FK-5-1-12 may be used for the following classes of fire:



Class A – flammable combustibles (creating flames)



Class B – flammable liquids



Class C – flammable gaseous substances



System is suitable for fire suppression of electrical equipment under voltage

Always consult suitability of use of the system and type of extinguishing agent in specific conditions with the supplier.

Although the extinguishing agent is not toxic or poisonous, unnecessary excessive exposure of persons to its influence should be avoided. Under no circumstances should persons be exposed to the extinguishing agent for more than 5 minutes even if an extinguishing concentration is not exceeding LOAEL level (see toxicity information in Table 33).

The BlazeCut system is primarily designed for small enclosed areas and equipment where people are not normally present (or only for a short time for inspection, maintenance, etc.).

More information about HFC-227ea and FK-5-1-12 can be found in the Safety data sheets supplied by the manufacturer on the BlazeCut website or the distributor.

6.4 SOME PHYSICAL AND CHEMICAL PROPERTIES

Table 33: Properties of HFC-227ea

Property	Description
Global warming potential	3220
Ozone depletion potential	0
Chemical name	1,1,1,2,3,3,3-Heptafluoropropane
Formula	CF ₃ CHFCF ₃
CAS number	431-89-0
Extinguishing concentration*	6.7 % of volume
Boiling point at pressure 1 bar	-16.34 °C
Freezing point	-131 °C
Critical temperature	101.75 °C
Critical pressure	2925 kPa
Critical density	621 kg/m ³
Density in liquefied form at 25 °C	1387.7 kg/m ³
Pressure of saturated vapours at 25 °C	454.73 kPa
Molecular weight	170
Dielectric Strength at 1 atm, 25 °C (N ₂ =1)	2.0
Dielectric Strength in kV (vapor)	13.9
Toxicity LC ₅₀ (4 h inh.)	800 000 ppm
Toxicity AEL	1000 ppm
Toxicity NOAEL	9 % concentration, 90 000 ppm
Toxicity LOAEL	10.5 % concentration, 105 000 ppm
Flammability	inflammable substance
Form	liquefied gas
Colour	colourless substance
Odour	odourless

*Extinguishing concentration determined for reference substance n-Heptane

Table 34: Properties of FK-5-1-12

Property	Description
Global warming potential	1
Ozone depletion potential	0
Chemical name	Dodecafluoro-2-methylpentan-3-one
Formula	CF ₃ CF ₂ C(O)CF(CF ₃) ₂ or C ₆ F ₁₂ O
CAS number	756-13-8
Extinguishing concentration*	4.5 % of volume
Boiling point at pressure 1 bar	49.2 °C
Freezing point	-108 °C
Critical temperature	168.7 °C
Critical pressure	1865 kPa
Critical density	639.1 kg/m ³
Density in liquid form at 25 °C	1600 kg/m ³
Pressure of saturated vapours (at 25 °C)	40.4 kPa
Molecular weight	316.04
Dielectric Strength at 1 atm, 25 °C (N ₂ =1)	2.3
Dielectric strength in kV (vapour)	16
Dielectric Strength in kV (gaseous mixture 5 % in air)	9.2
LC ₅₀ (4 h inh.)	100 000 ppm
Toxicity NOAEL	>10 % concentration, 100 000 ppm
Toxicity LOAEL	10 % concentration, 100 000 ppm
Flammability	non-flammable substance
Form	liquid
Colour	colourless substance
Odour	Slight odour

*Extinguishing concentration determined for reference substance n-Heptane

6.5 IMPROPER USES OF THE EXTINGUISHING AGENT

Extinguishing agent is not suitable for fire suppression in spaces with:

- certain chemicals or mixtures of chemicals, such as cellulose nitrate and gunpowder, which are capable of rapid oxidation in the absence of air;
- reactive metals such as lithium, sodium, potassium, magnesium, titanium, zirconium, uranium and plutonium;
- metal hydrides;
- chemicals capable of undergoing autothermic decomposition, such as certain organic peroxide, pyrophoric materials and hydrazine.

6.6 WARNINGS



During the system activation the extinguishing agent emerges from the BlazeTube detection under high pressure and at very low temperature. It is recommended that the automatic activation function of the system is deactivated when working less than 1 metre from the BlazeTube detection (see Chapter [11](#)).



No permanent workplace should be placed less than 1 metre from the system if the system is not installed in enclosure that prevents the extinguishing agent being discharged onto the people or no other barriers are in place preventing the extinguishing agent being discharged onto the people.



Extinguishing agent under normal (atmospheric) pressure evaporates quickly. Do not breathe its vapours. Exposure to high concentrations may cause health problems: a temporary loss of nerve activity, numbness, dizziness, confusion, loss of coordination, drowsiness, unconsciousness, irregular heartbeat, palpitations, depression, fainting, and weakness. Exposure to extreme concentrations of extinguishing agent may cause death without warning.



Extinguishing agent is heavier than air in a gaseous state. Accumulation in enclosed or low area may cause lack of oxygen and suffocation. After use of the system use natural or forced ventilation and do not enter thereafter.



HFC gases in liquid form may cause frostbite upon contact with eyes and skin. Avoid contact of liquid extinguishing agent with eyes and skin.



For installation, inspection, maintenance and repair of the system always use eye protection – wear appropriate protective glasses with side-shields and appropriate protective impervious working gloves.



Extinguishing agent is subject to thermal decomposition and forms toxic products – hydrogen halides after exposure to high temperatures in the fire area. Avoid exposure of extinguishing agent to high temperatures. After fire is indicated take precautions to avoid exposure of extinguishing agent to high temperatures. After use of the system secure the area by natural or forced ventilation. Use the system only in permissible ways required by the manufacturer.

The most dangerous by-product of thermal decomposition of the extinguishing agent is hydrogen fluoride (HF). It is a gaseous substance, irritating and toxic, it is dissolved in water in mucous membrane creating hydrofluoric acid. Symptoms of HF exposure depend on the intensity and duration of exposure and are mainly as follows:

- irritation of eyes and mucous membranes of the nose,
- total respiratory irritation at a high concentrations,
- irritation to the skin at high concentrations,
- without medical assistance very high concentrations can cause death.

6.7 HANDLING OF HFC GASES

Systems BlazeCut CEA(116, 118, 126, 128) contains clean extinguishing agent HFC-227ea. This is fluorinated greenhouse gas. Installation of the system, its activation and repair and maintenance is governed by specific legislation and may be performed only by persons with professional qualification.

Operation of the system is also governed by specific legislation and performing relevant gas leak inspections.

Operator of the system must prevent leak of HFC gases and as soon as possible repair any detected leak using all measures which are technically feasible and do not entail disproportionate costs.

Operator of the system is obliged to ensure recovery of the gases by a person with professional qualification in case of maintenance or expiration of containers holding HFC gases. This means gathering and storage of gases and ensuring their recycling, regeneration or destruction.



Do not open the valves of the cylinder and components before completing the system. Do not activate the system without reason.



Always have appropriate detection device for inspection of leak of HFC gases used in BlazeCut system during the installation, maintenance and inspection of the system. Always follow the manual of the detection device.



In case of suspected leak of extinguishing agent, it is essential that the operator of the system shall take corresponding measures immediately to prevent leak of extinguishing agent and repair any detected leak as soon as possible.

NOTE:

For the purposes of the next chapters "Inspection for leak" means that the equipment or system is tested for leak using direct or indirect measuring methods, focusing on those parts of the equipment or system, which are most likely to leak.

7 INSTRUCTIONS FOR INSTALLATION OF THE SYSTEM

7.1 GENERAL RULES

All parts of the system must be placed into the protected enclosure so that they are not in direct contact with parts of the protected equipment or in the immediate vicinity of the equipment parts that reach high temperatures during operation (transformers, engine block, exhaust pipes, etc.), not exposed to aggressive chemical substances (caustic, acids, solvents, corrosive substances etc.) and it is not exposed to direct atmospheric influences.

All components of the BlazeCut system must be firmly secured by using the recommended fixings to avoid movement and vibration. Do not secure any components to parts, which may move when the protected equipment is in operation.

Choose mountings so that fastening components are not damaged when the device is in operation. Accidental displacement of any part of BlazeCut system from the place of installation may result in reduction of the extinguishing effect of the system, its damage or device damage.

When fastening the system, make sure not to damage other parts of the device.

The system has to be positioned so that it is possible to perform future maintenance, component replacement, inspections and optimising safety of the pressurized equipment. Do not secure any components that will interfere with future inspection and maintenance of the equipment.

Ensure that no part is damaged after closing off the protected enclosure (e.g., after closing the covers/doors of the installation, engine etc.) and that no part is affected by moving parts of the equipment (fans etc.).

When fastening the system, make sure not to damage other parts of the equipment.

Do not overload the threads on the components, do not tighten or release the threads on the components forcibly, use the correct tightening torque. Make sure not to damage the components of the system by tools. Always check that the thread is clean and undamaged before installation.

During handling and installation of components of the system do not strain the components or handle forcibly.

In the event of subsequent changes in the protected enclosure during operation of BlazeCut system, always check whether changes are or not necessary in the installation of the system, relocation of BlazeTube detection etc. to secure the functionality and efficiency of the system.



Installation of the system, its activation and repair and maintenance is governed by specific legislation and these activities may only be performed by persons with relevant professional qualification subject to applicable legislation. Depending on procedure, also a relevant training or authorization by the manufacturer is required. Unprofessional interference with the system may cause malfunction of the system and provides danger to safety and health of people.



After the installation of the system the configuration is under constant pressure. Never tamper with the system under pressure.



In the case of work in the vicinity of electrical equipment observe corresponding safety rules and instructions. Do not perform installation and maintenance of the system when the equipment is in operation. In the case of work in the vicinity of electrical equipment observe corresponding safety rules and instructions. Work on electrical installations may be performed only by qualified persons.



Install and use BlazeCut system only with original supplied components. Do not replace anything in the system; use only original component and spare components. Using components not approved by the manufacturer causes loss of warranty, may cause malfunction of the system and presents danger to life and health of persons.



Do not install the cylinder to configuration if non-corresponding pressure is detected in the cylinder during inspection.



When handling parts of the system under pressure (cylinder, valves, Pressure Switch/Transducer, BlazeTube detection) always wear appropriate protective glasses with side-shields. Eyes may be seriously damaged when coming into contact with extinguishing agent in case of sudden leak.



If leak of liquid extinguishing agent occurs, always prevent contact with skin. Use suitable impermeable protective work gloves.



During installation and maintenance of a system with HFC gases, have appropriate detection device for inspection of leaks of HFC gases used in BlazeCut system available at all times.



Refrain from handling the system, if it was exposed to high temperature (as a result of operation of the protected device or after exposure to fire etc.). If the system is hot, temperature of extinguishing agent increases and pressure in the system increases. In this case the BlazeTube detection cannot be put under mechanical stress. Splashing of hot extinguishing agent under high pressure may cause serious injury. Wait until the system cools off naturally.

7.2 INSTALLATION OF THE CYLINDER AND BRACKET

In order to release the extinguishing agent by pressure, there is a dip tube in the cylinder. Therefore, the cylinder is required to be installed in vertical position. If the cylinder is leaning, the extinguishing agent may not be fully released, the greater the mounted angle of the cylinder the higher risk of the agent not discharging entirely.

The cylinder should be placed as close to the protected area as possible, so that the BlazeTube detection can be as short as possible. If the cylinder is placed directly into the protected area, the cylinder should be protected from elevated temperatures or potential damage if necessary.

AUTOMATIC FIRE SUPPRESSION SYSTEMS



The cylinder should be placed so that the cylinder label is visible, and the current pressure can be read on the pressure gauge and be readily accessible to allow future servicing or inspection.

Only install undamaged cylinders that are properly labelled and with the correct mounted cylinder valve. The cylinder can be supplied pressurized to the required pressure at the time of filling. The current pressure can be determined by reading the value on the pressure gauge, which is mounted on the cylinder valve when the system is supplied.



Do not install the cylinder, if the pressure is significantly different from values stated on the cylinder label or stated in this manual.

Carefully select a firm and secure part of the equipment to install the cylinder bracket using appropriate fasteners. If necessary, fabricate additional support to mount the cylinder. The cylinder must be properly fastened in the bracket using the bracket straps supplied. Once installed ensure all fastenings are firm and have no risk of loosening.

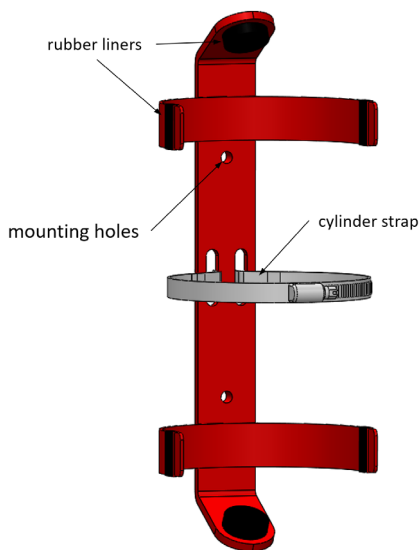

Light bracket

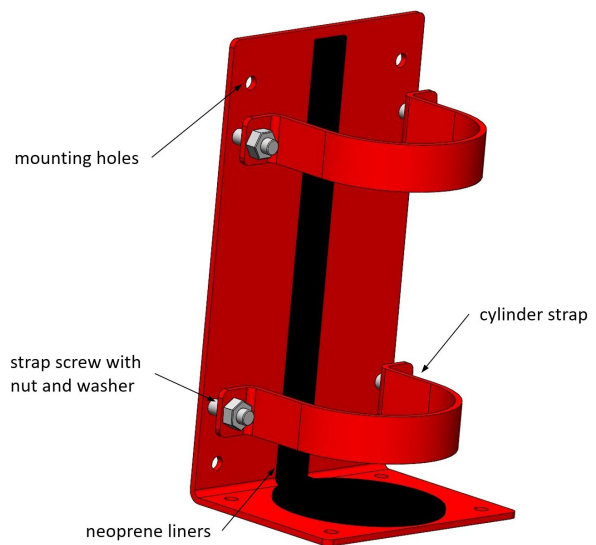

Heavy duty bracket

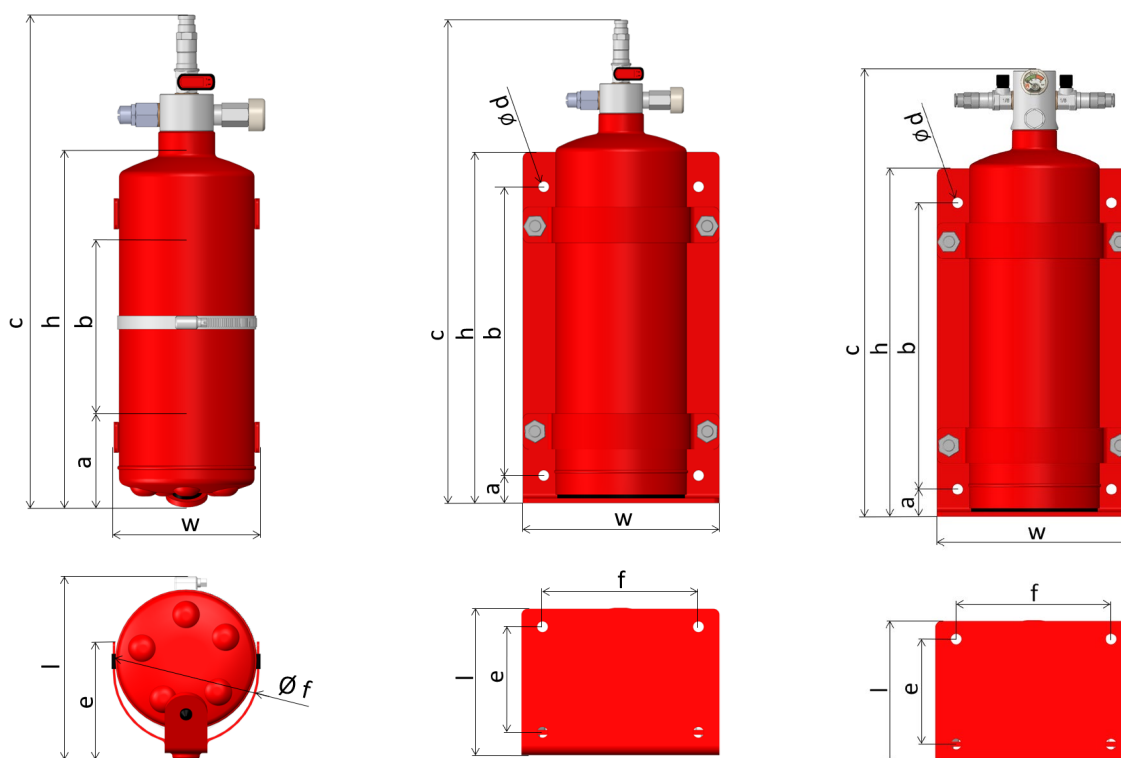

Cylinder with 116 or 118 valve in a light bracket ACB012

Cylinder with 116 or 118 valve in a heavy-duty bracket

Cylinder with 126 or 128 valve in a heavy-duty bracket

Table 35: Brackets

Part No	l × w × h [mm]	a [mm]	b [mm]	Ø d [mm]	e [mm]	f [mm]	Material	Colour	Operating temperature
ACB012	104×96×241	59	120	5.5	63	Ø 90	powder coated steel	red RAL3000	-40 to +80 °C
ACB124	122×165×294	23	242	9	83	130	powder coated steel	red RAL3000	-40 to +80 °C
ACB150	162×220×314	25	270	9	123	180	powder coated steel	red RAL3000	-40 to +80 °C

Table 36: Cylinder assembly dimensions and weights (cylinder with valve fitted in a bracket)

Cylinder volume [L]	Bracket	Valve type	Total height c [mm]	Total weight [kg]*
1.2	ACB012	116	333	1.74
		118	333	1.75
2.4	ACB124	116	406	4.50
		118	406	4.51
		126	378	4.78
		128	378	4.79
		116	434	6.75
5.0	ACB150	118	434	6.75
		126	406	7.02
		128	406	7.03
		128	406	7.03

*all weights do not include extinguishing agent.

When placing the cylinder, leave free area around the cylinder valve of minimum 100 mm on the sides and above the valve, to install other components of the system and perform maintenance of the system in future.

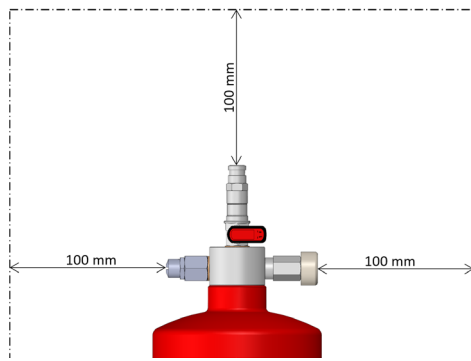

Example with the valve 116, 118

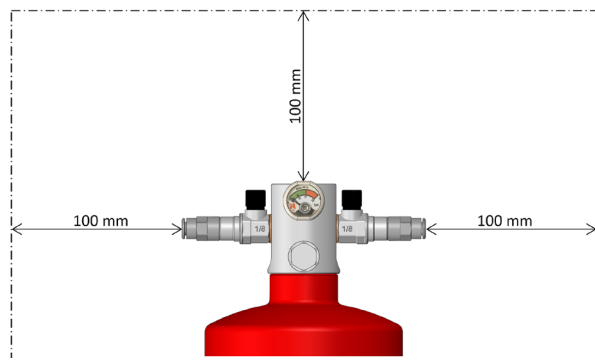

Example with the valve 126, 128

7.3 INSTALLATION OF THE BLAZETUBE DETECTION

Table 37: Tool charging kit

Model	Included components
KATC001	1 x adjustable regulation valve (Standard W 24,32x1/14") 1 x Charging adapter ATC001 2 m BlazeTube, 6 mm 1 x BlazeTube cutter



Tool charging kit KATC001

The efficiency of BlazeCut system significantly depends on correct placement of the BlazeTube detection. Follow the instructions below. The BlazeTube must be placed so that it is disrupted as soon as the fire starts, before damaging other components of BlazeCut system and before the fire spreads outside of the protected enclosure.

BlazeCut system uses quick slotting system of mounting BlazeTube detections in connectors with double seal to prevent leak of extinguishing agent and of pressure. Use only the connectors supplied with the system. Ends of the BlazeTube detection must be properly adjusted. End of the BlazeTube detection must be straight before inserting, without cuttings and notches to avoid damaging the seals in the BlazeTube connectors.

To cut the BlazeTube detection use special cutter ATC002 included in the Tool charging kit KATC001.

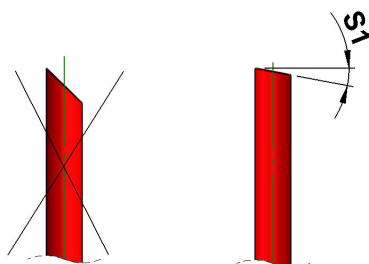

Example of incorrect (left) and correct (right) BlazeTube end cuts



BlazeTube cutter ATC002

Step 1. Cut the BlazeTube detection straight, maximum degree of chamfer is 5°

Fasten the BlazeTube detection firmly so that it is slotted into the BlazeTube outlet connector and pushed all the way by hand. After slotting always check if the BlazeTube is firmly fastened by gently pulling it. Do not open the ball valve on the BlazeTube outlet connector yet.

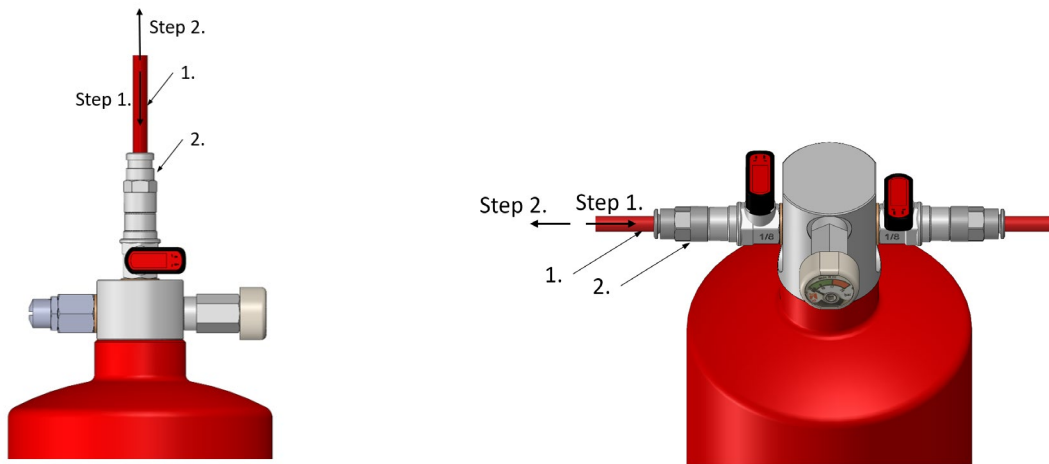

Scheme of connecting the BlazeTube detection to the connector on the cylinder valve (example: valve 116 and 118 on the left, valve 126 and 128 on the right)

1. BlazeTube Detection
2. BlazeTube Detection outlet

Step 1. Slot the BlazeTube detection firmly into the *BlazeTube connector* all the way in
Step 2. Pull the BlazeTube detection slightly and make sure that it is firmly fastened

Always slot the BlazeTube detection to the outlet adapter all the way in.

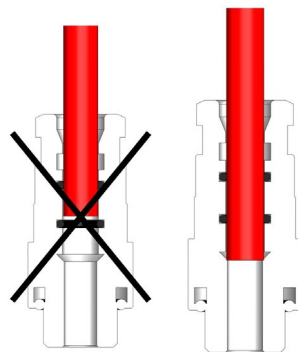

Detail of slotting the BlazeTube detection to the outlet connector



Do not open the ball valve before pressurizing the BlazeTube detection, this will release the extinguishing agent! Protect the ball valve from accidental opening during transportation and handling of the cylinder. Follow the instructions for transportation of the cylinder.



During normal operation of the system, the pressure in the BlazeTube detection is the same as in the cylinder.

Disconnect the BlazeTube detection from a BlazeTube connector by pushing the connector's ring in (away from the BlazeTube detection) and pull the BlazeTube detection away from the connector. Proceed accordingly when disconnecting the BlazeTube detection from the end-of-line adapter.

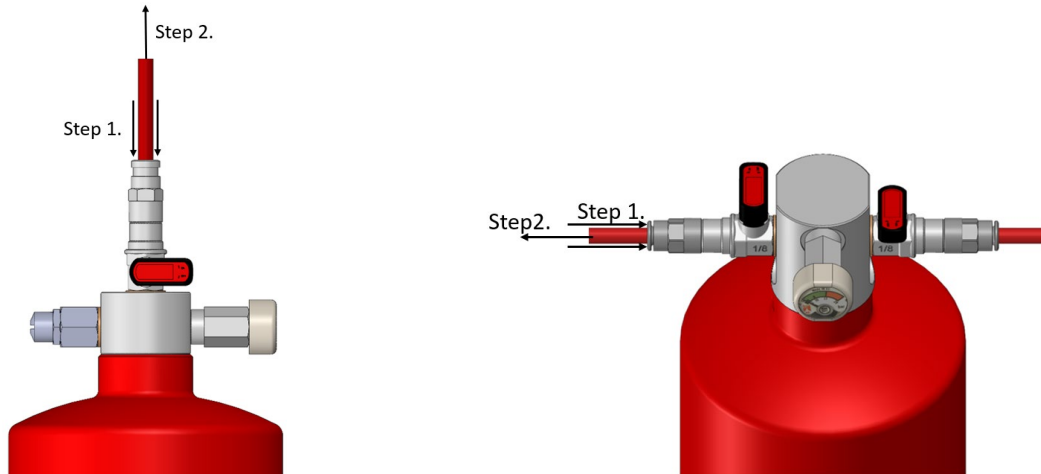

*Disconnection of the BlazeTube detection from the valve
(example: valve 116 and 118 on the left, valve 126 and 128 on the right)*

- Step 1: Push the ring of the BlazeTube connector
- Step 2: Pull the BlazeTube detection from the connector



During disconnection of the BlazeTube detection under pressure, a pressure is released and if the system was in operation, also small amount of agent is released. In such case always wear appropriate protective glasses with side-shields and suitable protective gloves. Aim the BlazeTube detection always apart. Make sure not to interpose any other person.

If the BlazeTube detection is under pressure disconnection can be more difficult. The pressure can be released by pushing a small pin of the charging adapter inside the end-of-line device. Before this procedure dismantle the pressure gauge and make sure that the ball valve is closed.

7.3.1 CONNECTION OF TWO BLAZETUBE DETECTIONS – TYPES C(EA, FK)(126,128)

Type of BlazeCut systems C(EA, FK)(126, 128) with valves 126 and 128 allow a connection of two BlazeTube detections. This solution provides better detection in the protected enclosure or protection of two separate enclosures with one system. Function of both BlazeTube detections is the same.



All instructions for connection and disconnection of both BlazeTube detection are the same. All systems can be installed with only one BlazeTube detection.

If you are using only one BlazeTube detection it is necessary to close the second unused BlazeTube outlet. To secure the agent discharge outlet use a FVP1B02 valve plug with G1/8" thread (optional component). The procedure is described below.

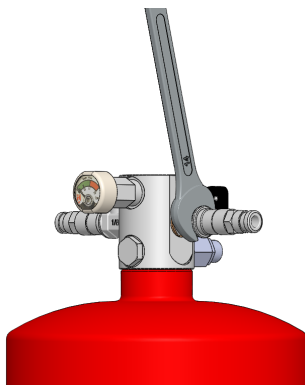

Step 1: The assembly of ball valve, gasket and outlet connector can be dismantled with a spanner 14 mm from the agent discharge outlet

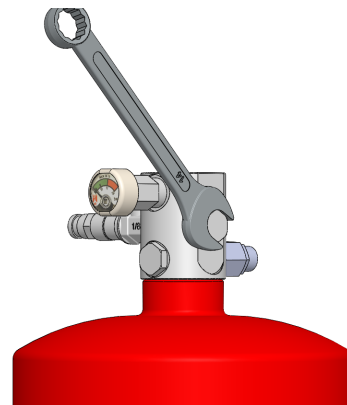

Step 2: Secure the G1/8" outlet with the FVP1B02 valve plug

7.3.2 INSTALLATION PROCEDURE OF THE BLAZETUBE DETECTION IN THE PROTECTED ENCLOSURE

Place the BlazeTube detection in the protected enclosure and gradually fasten it with P-clamps and fastening elements. Proper fastening of BlazeTube detection is important. In case of fire, it is exposed to fast changes in pressure and forces of flowing gas or extinguishing agent. Maximum distance between fastenings of the tube cannot be more than 250 mm. Fastening must also be in place where the tube bends. The BlazeTube detection has minimum bend radius of 100 mm. Do not bend the tube more. To preserve sufficient flexibility of the BlazeTube detection, it is recommended to install it at an ambient temperature of more than 10 °C.

IMPORTANT!

The BlazeTube detection must come out of each connection in direct position in order to avoid any leakage. If a redirection of the BlazeTube detection is needed, the bend of the tube from the connection must be in a minimum distance of 50 mm. To determine the required length of BlazeTube to be used in an enclosure, the horizontal mounting of BlazeTube is to be between 200 mm – 500 mm to ensure a more rapid actuation is achieved.

Table 38: Installation limitations of the BlazeTube detection for HFC-227ea and FK-5-1-12 DLP systems

Valve type	Total BlazeTube supplied in standard kit	Max. BlazeTube length from cylinder outlet to the tubes end point	Max. number of tubes connected to a single cylinder
116	10 m	10 m	4
118		10 m	
126	20 m	10 m	
128		20 m for loop	

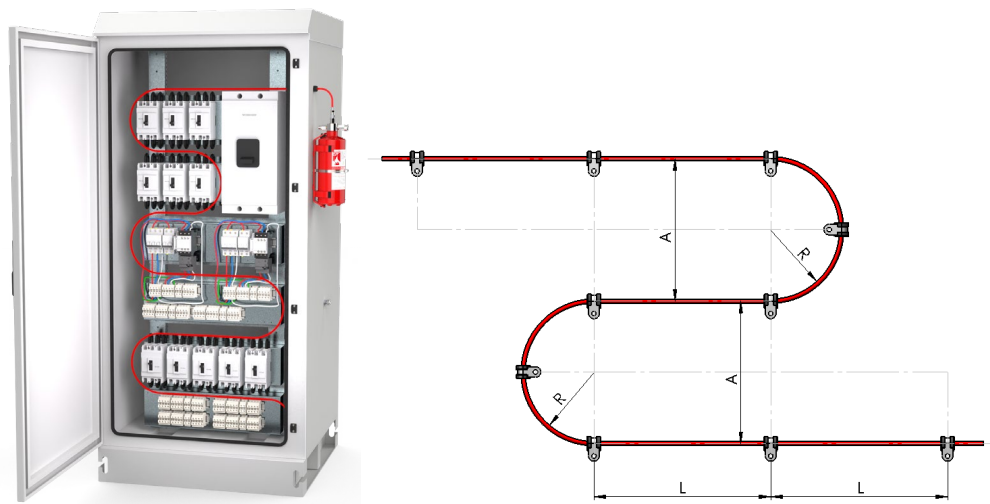

Installation of BlazeTube detection

Distance between installed BlazeTube detection and a fire hazard must stay between h_{min} and h_{max} .

h – distance between fire hazard and BlazeTube

L – distance between fastenings

R – bending radius

A – distance between BlazeTube detections

Table 39: Boundary distance values

Symbol	Value
h_{min}	0 mm*
h_{max}	150 mm

L	max. 250 mm
R	min. 100 mm
A	max. 1000 mm
Number of bends per 1 m	3

*Surface temperature of the protected item has to be within operating temperature of the BlazeTube (see [Table 15](#))

1. structure
2. BlazeTube detection
3. protective element (cable gland ACG112, rubber grommet etc.)

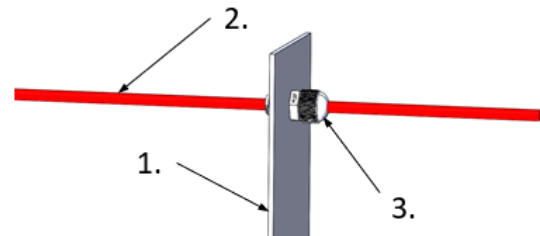

At the crossing of the BlazeTube through a structure it is advised to protect the BlazeTube

Place the BlazeTube detection as close as possible above the places with greatest risk of fire. Do not place the tube horizontally next to places of possible fire, it may significantly delay activation of the system in case of fire.

The BlazeTube detection cannot be placed freely in the protected enclosure. It must be tightened to appropriate construction. If necessary, the BlazeTube detection can be installed in open space (e.g., above the protected device) by using steel wire, which is wired in suitable area of the protected enclosure and the BlazeTube detection can be tightened on a steel wire. Use a steel wire with appropriate strength and secure the steel wire firmly.

Proceed carefully during installation not to damage the tube with sharp objects. Do not refract or forcibly bend the BlazeTube.

During the installation of BlazeTube detection, specifically make sure that the tube will not be damaged during operation of the device by mechanical stress. After the system is fully installed and functional, if the BlazeTube is damaged, and the pressure decreases the system will always activate.

The tube cannot be in direct contact with hot parts of the protected device or in immediate proximity of parts of the device, which heat to high temperatures during operation (transformers etc.).

Depending on the size and shape of the protected enclosure use necessary length of the BlazeTube detection. If you do not use the whole tube, cut the ending. The ending must be adjusted, see figures at start of this chapter.

Place the loose ending of the BlazeTube detection into the area so that it is possible to pressurize the system using external device through end-of-line adapter of the tube. It also enables in future to perform inspection of pressure in the system with pressure gauge on end-of-line adapter of the tube if the pressure gauge will be installed at the end-of-line.

Two end-of-line adapters are needed in systems C(EA, FK)(126,128) (*Example 3*). If the BlazeTube is connected in a closed loop configuration (*Example 3*), then one end-of-line adapter is sufficient.

Fasten the end-of-line adapter into the ending of the BlazeTube; proceed according to the figure below.

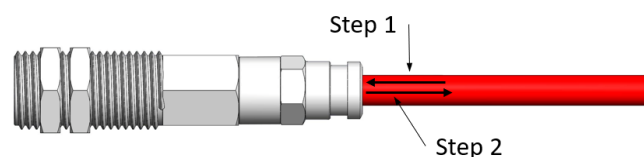

Connection of the BlazeTube detection on the end-of-line adapter

Step 1: Slot the BlazeTube detection firmly into the end-of-line adapter all the way

Step 2: After slotting always make sure that the BlazeTube is firmly fastened by gentle pulling it

7.4 PRESSURIZATION OF THE CYLINDER AND THE DETECTION SYSTEM

The BlazeTube detection must be pressurized with the correct pressure by nitrogen gas (N₂) before the system is put into operation. Use appropriate source of N₂ - cylinder with a control valve.



*Tool charging adapter
ATC001*

Pressurization is performed through the end-of-line adapter of the BlazeTube detection using charging adapter ATC001. The BlazeTube detection end-of-line adapter has outlet with a thread M10x1 and it contains a filling valve, which must be pushed and opened with the charging adapter.

This valve closes and opens automatically during removal or installation of the charging adapter or the pressure gauge. It is possible to install and remove these components even when the tube is under pressure.

If the system is using two BlazeTube detections you can use any of these tubes, as long as both ball valves on the outlets are open. During pressurization of one BlazeTube detection the second BlazeTube detection will be pressurized as well.

Proceed according to instructions in Chapter [8.3](#) to charge both the cylinder and BlazeTube with nitrogen at once.



Proceed carefully and strictly follow the following steps. Fasten the connectors of the tubes, charging adapter and BlazeTube detection firmly and inspect. Their accidental disconnecting during pressurization would release the extinguishing agent into the system.



Never connect or disconnect the charging adapter to the BlazeTube detection if the ball valve of the outlet of the BlazeTube detection on the cylinder valve is open.

7.4.1 PROCEDURE OF PRESSURIZATION OF THE CYLINDER AND THE DETECTION SYSTEM

Proceed according to instructions in this chapter to pressurize the cylinder and BlazeTube detection at once.

For pressurization of BlazeTube detection only, skip steps 6 and 7.

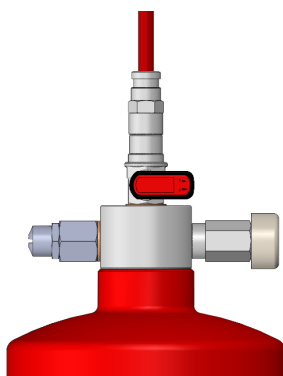

Cylinder valve 116 or 118

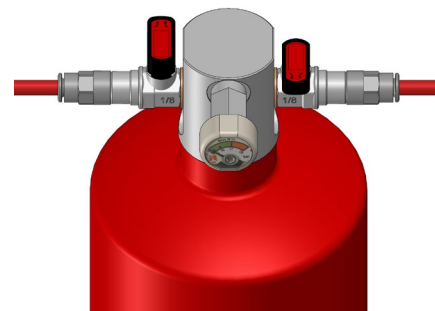

Cylinder valve 126 or 128

Step 1:

Close the ball valve(s) on the cylinder valve. Read and write down the value of pressure from the cylinder valve.

On valves 126 and 128 make sure BlazeTube ends from both the left and right outlets have an end-of-line adapter installed.

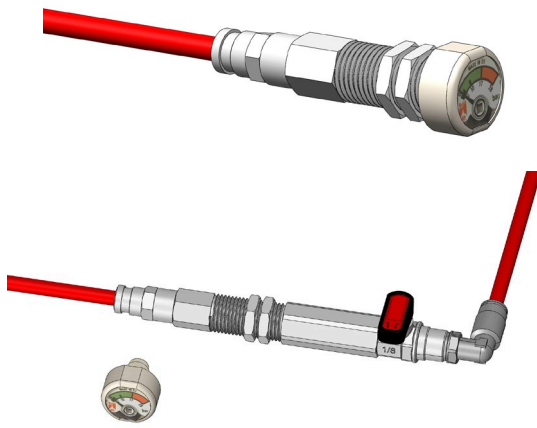

Step 2:

If installed, remove the pressure gauge (pressure switch or transducer) from the end-of-line adapter AEA006 at the end of the BlazeTube.

Step 3:

Make sure the ball valve on the charging adapter is closed.

Mount the charging adapter ATC001 to the end-of-line adapter's M10x1 port by rotating clockwise. Tighten the charging adapter properly.



Step 4:

Set the regulator on the source of N₂ to the desired value (**12 bar for HFC-227ea and 15 bar for FK-1-1-12 at 20 ± 3 °C ambient temperature**) Setting must be at least on the level of pressure in the cylinder increased by 1 bar. Graph of relationship between temperature and pressure in the cylinder is show in Chapter [4.1](#). Open the regulation valve.

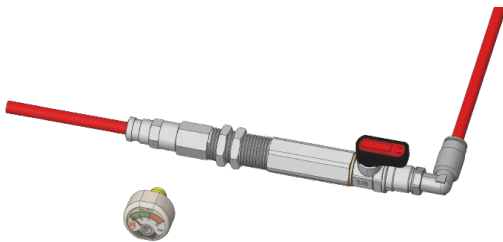

Step 5:

Slowly open the ball valve of the charging adapter and pressurize the BlazeTube detection first.

When pressurizing systems with valve 126 or 128, the BlazeTube detections have to be pressurized individually, except when they are in a loop configuration (*Example 3* in Chapter [7.3](#)).

Step 6.1 (for valve 116 or 118) (skip this step if pressurizing only the BlazeTube):

Slowly open the ball valve on the cylinder valve and pressurize the cylinder.

During pressurization hissing can be heard. When the hissing stops, keep the ball valve open for at least 30 seconds to stabilize the pressure.

Close the ball valve on the cylinder valve, shake the cylinder several times and repeat Step 6.1 until the pressure stays at the desired value.

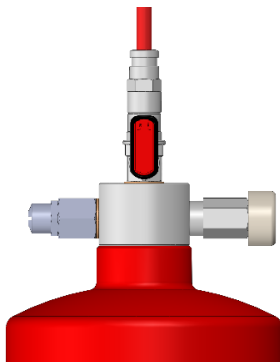

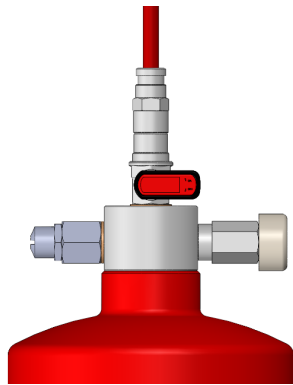

Step 7.1 (for valve 116 or 118) (skip this step if pressurizing only the BlazeTube):

Close the ball valve on the cylinder valve.

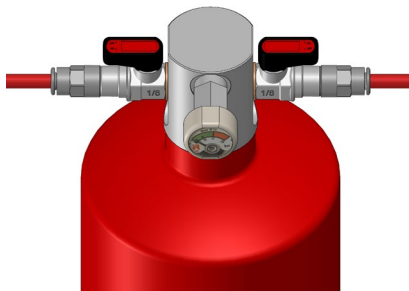

Step 6.2 (for valve 126 or 128) (skip this step if pressurizing only the BlazeTube):

After both BlazeTubes are pressurized, slowly open both ball valves on the cylinder valve and pressurize the cylinder.

During pressurization hissing can be heard. When the hissing stops, keep the ball valves open for at least 30 seconds to stabilize the pressure.

Close both ball valves on the cylinder valve, shake the cylinder several times and repeat Step 6.2 until the pressure stays at the desired value.

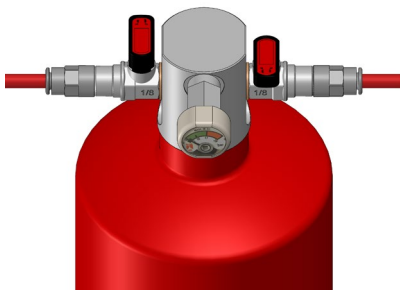

Step 7.2 (for valve 126 or 128) (skip this step if pressurizing only the BlazeTube):

Close both ball valves on the cylinder valve.

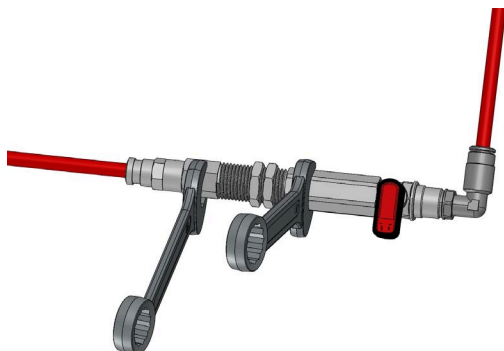

Step 8.

Close the ball valve of the charging adapter.

Step 9:

Unscrew the charging adapter from the M10x1 port of the end-of-line adapter (with size 16 spanner). You can use size 14 spanner on the valve adapter to push clockwise while unscrewing the charging adapter

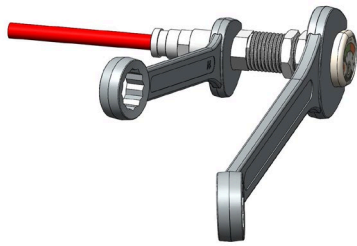

Step 10:

Mount the pressure gauge (pressure switch or transducer) back. Tighten it with spanner 22 mm.

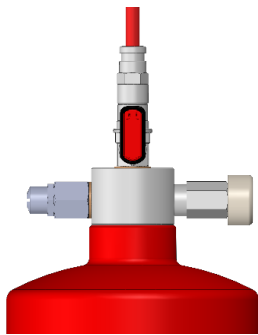

Cylinder valve 116 or 118

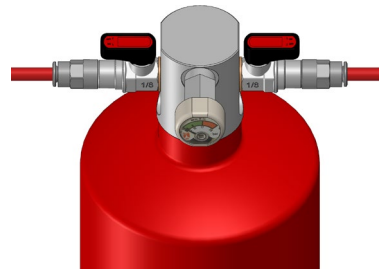

Cylinder valve 116 or 118

Step 11:

If the pressure is not decreasing, very slowly open the ball valve on the cylinder valve. Pressures in the tube and the cylinder will equalise. Wait approximately 30 seconds.

Follow additional steps from Chapter [7.4.2](#).



Since this moment, the cylinder and the BlazeTube detection are connected in one pressure unit. Proceed carefully not to damage the BlazeTube detection. Its damage would cause activation of the system and release of extinguishing agent.



Do not try to remove the BlazeTube detection from the BlazeTube outlet on the cylinder valve or remove the end-of-line adapter if the BlazeTube is under pressure and the ball valve is open.

7.4.2 ADDITIONAL STEPS AFTER PRESSURIZATION

Observe the value on the cylinder valve's pressure gauge and check the system components for leaks right away and after 30 minutes. If pressure is decreasing, the BlazeTube detection may not be connected properly, or some component may not be mounted tightly. Also check the connection between the cylinder neck ring and the cylinder valve using a foaming solution. Observe if no bubbles are formed due to loss of pressure through the connection.

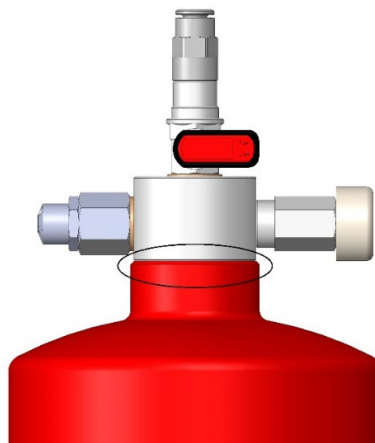

IMPORTANT!

Never install the cylinder assembly if any leak is detected!

7.4.3 ADDING LABELS

After completing all the previous steps, apply the warning label ALA008 to the protected enclosure. Fill out the label *Cylinder service record* ALA036 and attach to it contact information of the certified servicing body. Apply the filled-out label onto the protected enclosure to an accessible place.

7.5 FINAL INSPECTION OF THE SYSTEM INSTALLATION

Fill-out the Commissioning/Installation Report. It shall cover as a minimum:

1. Pressure and system leak test
2. Clear tube runs, no burrs, kinks or excessive curvatures
3. Operation of fault alarms and power cut outs
4. Warning and service labels shall be installed in a visible place on the enclosure
5. Safety warning notifications and handover documentation

8 REGULAR INSPECTION AND MAINTENANCE OF THE FIRE SUPPRESSION SYSTEM



Pressure configuration of the system is reserved technical equipment under pressure. Its activation and operation is subject to professional inspections and tests performed by revision technician according to applicable legislation. Operator is obliged to have inspections of safety condition of the equipment performed and immediately remove defects detected.



Always follow local legislation and statutory requirements.



All inspections (except daily operator's checks) and repairs, whether during regular maintenance or in exceptional situation, must be performed by a person authorized and trained by the manufacturer and depending on the procedure with corresponding professional qualification to ensure correct operation of the fire suppression system.

Required system inspection and maintenance must be followed to ensure long term, reliable and safe operation of BlazeCut system.

Visual inspections of the fire suppression system shall be carried out regularly at least once a month by the responsible person. Overall inspection must be performed at least once per 12 months for non-harsh environments and once per 6 months for harsh environments. Inspection must be performed also after each exceptional circumstance (e.g., exposure to mechanical or excessive thermal stress for example in case of fire without activation of the system).

In case of performing exceptional inspection, the 12-month period to perform the next regular inspection starts only when exceptional inspection was performed in full scope.

Regular replacement of components subject to wear and tear (effects of temperature, pressure and environment) is also necessary in BlazeCut system.

If necessary, inspection of leaks of HFC gases used in BlazeCut systems C(EA)(116, 118, 126, 128). For the inspection see Chapter 6.6, pressurization of the system see Chapter 8.3 or inspection of weight of extinguishing agent in the system see Chapter 8.4.

For non-harsh environments proceed according to the instructions in Table 40. For harsh and mobile environments please refer to our service report sheets.

Table 40: Overview of inspections in non-harsh environments (internal fixed installations)

Period / interval	Obligatory scope
-------------------	------------------

Daily operator's check	<ol style="list-style-type: none"> 1. Check system pressure 2. Fire Alarm Panel check (if used) 3. Visual inspection of system: check for loose and/or damage to cylinder assembly, brackets, detection, wiring, etc.
1 x 12 months	<ol style="list-style-type: none"> 1. Overall inspection of the system 2. Inspection of pressure in the system
1 x 5 years	<ol style="list-style-type: none"> 1. Overall inspection of the system
1 x 10 years	<ol style="list-style-type: none"> 1. Overall inspection of the system 2. Pressure test of the cylinder 3. Replacement of BlazeTube detection
In special incident	<ol style="list-style-type: none"> 1. Overall inspection of the system 2. Inspection of pressure in the system
As necessary	<ol style="list-style-type: none"> 1. Inspection of weight of extinguishing agent in the system 2. Inspection with the detection device for the inspection of leaks of HFC gases* 3. Pressurization of the system

*only for systems C(EA)(116, 118, 126, 128) with HFC-227ea

If any deficiencies are found, appropriate corrective action shall be taken immediately.

Inspection and test intervals stated in the table are minimum intervals required by the manufacturer. If the legislation in place of installation requires shorter intervals as stated in the table or additional inspections and tests, which are not stated in the table, it is necessary that these inspections are performed in accordance with this legislation.

Agents removed from containers during service or maintenance procedures shall be recovered and recycled or disposed of in accordance with any applicable laws and regulations.

8.1 OVERALL INSPECTION OF THE SYSTEM

Basic points of inspection of the system:

- check completeness of the system,
- clean surface of the cylinder and the cylinder valve, BlazeTube detection and pressure gauge from major dirt with a clean cloth,
- check surface of the cylinder, focus on possible changes in shape of the cylinder, mechanical damage, signs of corrosion, signs of leak, etc.; in case of damage of the cylinder or the cylinder valve replace them immediately,
- check firmness of the connection of the BlazeTube detection to the cylinder valve and firmness of the connection of the end-of-line adapter, BlazeTube connectors or plugs of the BlazeTube detection by gently pulling the tube,
- check that the BlazeTube detection is not damaged, focus on possible change of shape, colour, dents, damage caused by temperature or mechanical damage; in case of damage replace it,
- check firmness of the fastening of the cylinder in the bracket, check the fastenings of the tubes, firmness of the fastening of the electrical installation, check firmness of the mounting of the cable connectors to the Pressure Switch/Transducer,
- clean and check that all corresponding labelling of the system and warning labels marking the area protected by BlazeCut system are undamaged; if they are damaged, replace them.

Remove detected defects immediately. During replacement of components and reconnecting the tubes, the electrical installation and during pressurization of the system proceed in accordance with the procedures described in Chapter [12](#).

8.2 INSPECTION OF PRESSURE IN THE SYSTEM

8.2.1 GENERAL RULES

The pressure of the system is inspected by control pressure gauge situated on the cylinder valve (if the Pressure Switch/Transducer is not installed) or on the end-of-line adapter. If both pressure gauges are installed use the most accessible pressure gauge.

AUTOMATIC FIRE SUPPRESSION SYSTEMS



During inspection of pressure, the ball valve on the cylinder valve must be open to inspect pressure in the system correctly (like during regular operation of the system). During inspection, the system cannot be heated (e.g., during operation of the protected enclosure) and exposed to a direct sunlight.

8.2.2 DAILY OPERATOR PRESSURE CHECK

Read the pressure gauge. If the pressure is within the green zone, the system is operational. If the pressure indicator is in the red zone, contact the service technician.



Pressure level is optimal



Pressure level is critical

If the system is using a Pressure Switch APS001-xx for monitoring of low pressure or a Pressure Transducer ATA100 for constant monitoring with the AAP210 panel the visual check of pressure gauge is not necessary as the alarm panel will notify the operator by warning light and buzzer on the panel, in case of low pressure.

8.2.3 12-MONTH PRESSURE INSPECTION



When mounting and unmounting the pressure gauge or control pressure gauge to the end-of-line device, the ball valve of the outlet of the BlazeTube detection must be always closed.

During inspection proceed as follows:

- Read the pressure from a pressure gauge (on the cylinder valve or end-of-line adapter) and remove it.
- Measure pressure by installing control pressure gauge (with adapter compatible with outlet M10x1) and compare detected value with data from the pressure gauge of the system. Values must be equal, permissible tolerance of pressure is maximum 1 bar. In case of discrepancy, replace the pressure gauge of the system.
- If the control pressure gauge detects pressure in the system lower by more than 10 % than the required value of pressure, taking into consideration ambient temperature (see Chapter [4.1](#)), perform the pressurization of the system, and proceed according to Chapter [8.3](#).
- If the control pressure gauge detects pressure in the system lower by more than 20 % than the required value of pressure, taking into consideration temperature (see Chapter [4.1](#)), it is possible that the system is not tight. Proceed as follows:
- Perform inspection for leak of extinguishing agent with detection device for the inspection of leaks of HFC gases used in BlazeCut system (if the inspection is performed, see Chapter 6.6 - only for systems C(EA)(116,118,126,128) with HFC-227ea;
- Perform inspection of the amount of extinguishing agent in the system by weighting the cylinder, proceed according to Chapter [8.4](#).

8.3 PRESSURIZATION OF THE SYSTEM

During the operation of the system there is always a natural slight pressure leak in the system. The leak occurs on the BlazeTube connectors and through the BlazeTube detection itself due to permeability of the material. The operation conditions and the size of the cylinder also influence the pressure decrease. Therefore, it is necessary to pressurize the system occasionally if the pressure decrease is more than 10 %.

During pressurization of the system during maintenance, the cylinder is also pressurized as opposed to pressurizing only the BlazeTube detection during installation.

Follow steps in Chapter [8.3](#).

8.4 INSPECTION OF WEIGHT OF THE EXTINGUISHING AGENT IN THE SYSTEM

Inspection of weight of extinguishing agent in the system is performed:

AUTOMATIC FIRE SUPPRESSION SYSTEMS



- If the control pressure gauge detects pressure in the system lower by more than 20 % than the required value of pressure, taking into consideration temperature (see Chapter 4.1),
- If leak is detected by the detection device for the inspection of leaks of HFC gases used in BlazeCut system during operation of the system (if the inspection is performed, see Chapter 6.6 - only for systems C(EA)(116,118,126,128) with HFC-227ea,
- 1 x 5 years.

To inspect the amount of extinguishing agent in the system by weighting the cylinder with the valve attached, the cylinder must be removed from the system. Proceed according to Chapter 12.2.

If decrease of weight of extinguishing agent by more than 5 % is detected when weighting the cylinder, the cylinder must be replaced.

Decrease of weight of extinguishing agent can be calculated according to the formula:

$$P = \left(\frac{M_1 - M_2}{M_3} \right) 100\%$$

P – decrease of weight of extinguishing agent in percent (%)

M_1 – weight of the cylinder and valve including extinguishing agent* [kg], $M_1 = M + M_3$

M_2 – weight of the cylinder and valve including extinguishing agent detected by weighing [kg]

M_3 – amount of extinguishing agent [kg]; amount of extinguishing agent is marked on cylinder label (see Chapter 4.1)

Table 41: Systems C(EA, FK)(116, 118, 126, 128)

Volume of the cylinder [L]	Valve	M [kg] *
1.2	116	1.42
1.2	118	1.43
2.4	116	1.90
2.4	118	1.91
2.4	126	2.18
2.4	128	2.19
5.0	116	2.85
5.0	118	2.85
5.0	126	3.12
5.0	128	3.13

* Weight of the empty cylinder with the valve and without the extinguishing agent, tolerance ± 0.05 kg

If the detected decrease of weight is not more than 5 %, install the cylinder back, proceed according to Chapter 12.2.

If leak of extinguishing agent is detected by detection device for the inspection of HFC gases or by other way, the leak must be removed before repeated installation of the cylinder.

8.5 REMOVAL OF THE SYSTEM FROM SERVICE

The system must be immediately put out of service in the following cases:

- The system has been activated or emptied for other reason.
- The system has been exposed to direct flame or temperatures exceeding the limits of the system operation.
- The cylinder or valve shows signs of damage (deformation, cracks, leaks and severe corrosion, unusual phenomena that cannot be inspected or removed during operation of the system).
- If the pressure in the system is significantly higher with the respect to the ambient temperature or if it exceeds the highest permissible pressure level of the system.

Subsequent measures to ensure safety of the system and protection of persons must be taken by the persons trained and authorized by the manufacturer and, depending on the procedure, with corresponding professional qualification. If necessary, contact your supplier of the BlazeCut system.

9 OPERATION OF THE BLAZECUT SYSTEM IN CASE OF FIRE

BlazeCut system is designed to protect closed spaces from fire using volume or local fire suppression applying clean extinguishing agent. BlazeCut system suppresses fire automatically without any external power source.

The fire suppression system operates by detecting fire and also application of the agent using a BlazeTube detection fastened to the cylinder valve. The BlazeTube detection is placed in the protected enclosure and is under constant pressure. In case of fire, the BlazeTube detection degrades by the effect of fire or high temperature. When the BlazeTube detection is disrupted, the agent is released through created "nozzle". This system is independent of any electrical supply and operates solely on physical principles.

If two BlazeTube detections are installed in systems C(EA, FK)(126, 128), function of both BlazeTube detections is the same.

Time necessary for degrading of the BlazeTube detection by direct effect of fire or minimum temperature necessary for degrading the BlazeTube detection depends on the pressure in the tube, which is affected by factors such as the level of pressurization of the system and ambient temperature. The higher the pressure in the tube, the sooner the tube degrades and the system activates.

If the Pressure Switch/Transducer installed on the cylinder valve is part of the system, it sends a signal to the external device (for example Alarm Panel AAP210).

Procedure during automatic activation of the system is described in figure below.

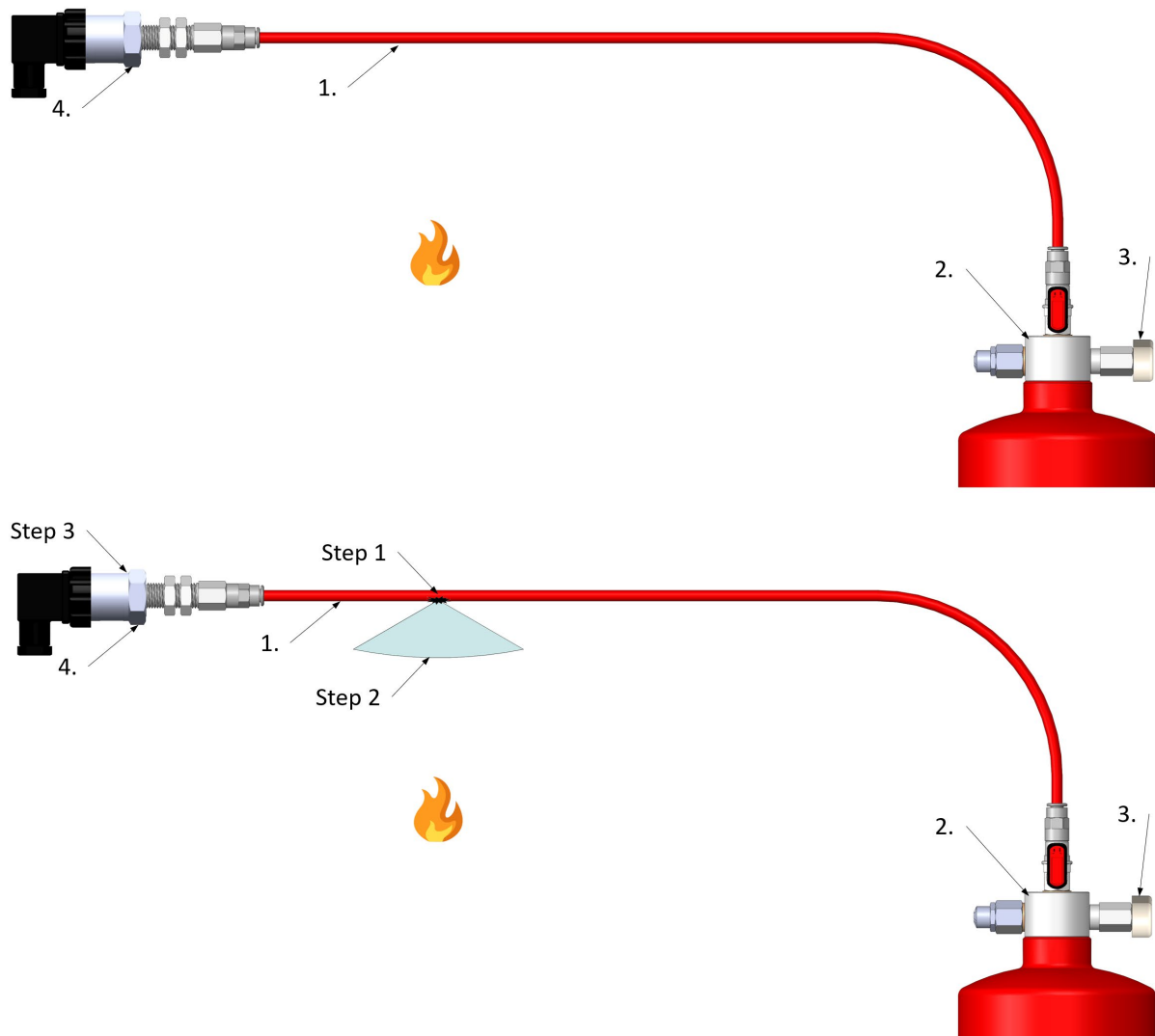

*Procedure during automatic activation of the system
(as an example system with valve 116 used, principle of functioning is the same for all valves)*

AUTOMATIC FIRE SUPPRESSION SYSTEMS



1. BlazeTube detection
2. Cylinder valve
3. Pressure gauge
4. *Pressure Switch/Transducer with cable connector
 - Step 1: Burning through the BlazeTube detection
 - Step 2: Release of extinguishing agent through created “nozzle”
 - Step 3: *The Pressure Switch/Transducer sends signal to external device after decrease of pressure in the system

*Applicable only if the Pressure Switch/Transducer is installed



In case of fire the system activates automatically by burning the BlazeTube detection without previous warning. Do not come to immediate proximity of the nozzle of the system in case of fire, there is a risk of being struck by extinguishing agent.



If the system is activated wait for its activity to finish. Do not enter the protected enclosures and do not open the covers of the protected enclosure during the activity of the system.

10 RESTORATION OF ACTIVITY OF BLAZECUT SYSTEM IN CASE OF FIRE



Install and use BlazeCut system only with original supplied components. Do not replace anything in the system; use only original component and spare components. Using components not approved by the manufacturer causes loss of warranty, may cause malfunction of the system and presents danger to life and health of persons.



The system may be installed, maintained and repaired only by persons trained or authorized by the manufacturer and depending on procedure also with relevant professional qualification. Unprofessional interference with the system may cause malfunction of the system and presents danger to safety and health of people.

AUTOMATIC FIRE SUPPRESSION SYSTEMS



Extinguishing agent does not leave residue. Ventilate the protected enclosure properly, do not interfere with or work in the area before ventilation.

After the fire extinguishing is finished, follow the instructions below:

- Enter the protected area only after the system operation is finished.
- Unless absolutely necessary (e.g., fire is still present and it is necessary to use a portable fire extinguisher), enter the protected area only after it has been properly ventilated and cooled off and make sure that entry is safe.
- If immediate entry is necessary, persons should be properly protected (using self-contained breathing apparatus, protective clothing, gloves, glasses etc.).

If the system is automatically activated in case of fire in the protected enclosure, it is necessary to replace several components. Proceed as follows:

- Check all components of the system for any damage. Any part that was exposed to direct fire or temperature above maximum operation temperature of the component shall be replaced,
- Disconnect the cable connector from the Pressure Switch/Transducer, if used in the system, and remove the Pressure Switch/Transducer from the cylinder valve. Check if electrical installation was not damaged, replace possible damaged parts,
- Disconnect the BlazeTube detection from the cylinder valve,
- Replace the cylinder with valve and extinguishing agent,
- Replace BlazeTube detection; BlazeTube detection is replaced always in whole length; BlazeTube detection is replaced always after exposure to fire – if both BlazeTube detections of system C(EA, FK)(126, 128) were installed in the same enclosure both BlazeTube detections must be replaced, remember that also the BlazeTube detection which has not been replaced must be pressurized again,
- Connect the cable connectors to the Pressure Switch/Transducer and check correct functioning of the electrical installation.

During installation of new components or their replacement and during repeatedly connecting electrical installation and pressurization of the system proceed according to instructions in respective chapters.

Proceed accordingly also in case of accidental discharge of the system.

11 SYSTEM DEACTIVATION

If necessary BlazeCut system may be disabled without removing it from the protected enclosure. Close the ball valve on the cylinder valve. In this case even after damaging the tube the cylinder valve does not open and extinguishing agent is not released.

When using system C(EA, FK)(126, 128) with two individual ball valves, both BlazeTube detections should be deactivated.

12 MAINTENANCE OF THE SYSTEM, REPLACEMENT OF COMPONENTS

12.1 GENERAL RULES

Follow general rules stated in Chapter [7.1](#).

Fill-out the Maintenance/Inspection Report.

12.2 REPLACEMENT OF THE CYLINDER

During replacement use only undamaged cylinder filled with the correct extinguishing agent, properly labelled, with correctly mounted cylinder valve. Cylinder assembly is supplied pressurized with required pressure. Detect the pressure in the cylinder with the pressure gauge mounted on the cylinder valve. Pressures corresponding to actual temperature are stated in Chapter [4.1](#).

If the pressure gauge is not mounted on the cylinder valve, external control pressure gauge with adapter compatible with an outlet with thread M10x1 on the cylinder valve or the pressure gauge of the BlazeCut system which is mounted on the end-of-line adaptor of the BlazeTube detection may be used. In such case, remove the

AUTOMATIC FIRE SUPPRESSION SYSTEMS



pressure gauge from the end-of-line adaptor of the BlazeTube detection and mount it to the outlet on the cylinder valve with thread M10x1.

During replacement of the cylinder proceed as follows:

- Disconnect cable connectors on the Pressure Switch/Transducer, if used in the system and remove the Pressure Switch/Transducer.
- Close the ball valve and disconnect the BlazeTube detection.
- Loosen the clamps of the bracket of the cylinder and remove it from the bracket.
- Place a new cylinder assembly into the bracket and fasten it properly with clamps.
- Connect the BlazeTube detection to the cylinder valve.
- Install the Pressure Switch/Transducer and connect the cable connector, if used in the system.
- After replacement of the cylinder have a corresponding inspection of the pressure device performed according to Chapter 8.
- After replacement of the cylinder with HFC-227ea have corresponding inspection and measures to prevent leaks of the HFC-227ea gas according to Chapter 6.6.
- During removal and installation of individual components proceed according to the instructions as stated in individual chapters relating to the components.

12.3 REPLACEMENT OF THE BLAZETUBE DETECTION



Do not try to remove the BlazeTube detection from the cylinder valve when the tube is under pressure and the ball valve on the cylinder valve is open.



Before handling the BlazeTube detection during removal, replacement or adjustment fastening in the protected enclosure, always close the ball valve on the cylinder valve where the tube is fastened. When the BlazeTube detection is connected to the cylinder valve and the ball valve is open, if the tube is damaged and the pressure decreases, the fire suppression system is always activated, and the extinguishing agent is released completely.



During disconnection of the BlazeTube detection under pressure a pressure is released and if the system was in operation also small amount of agent is released. In such case always wear appropriate protective glasses with side-shields and suitable protective gloves. Aim the BlazeTube detection always apart. Make sure not to interpose any other person.

1. Close the ball valve on the cylinder valve, position of the levers as shown in figures below.
2. If the BlazeTube detection is under pressure, remove the pressure gauge (pressure switch or transducer) from the end-of-line adapter AEA006 at the end of the BlazeTube, if installed. Push in the Schrader valve inside the end-of-line adapter to release the pressure from the BlazeTube.

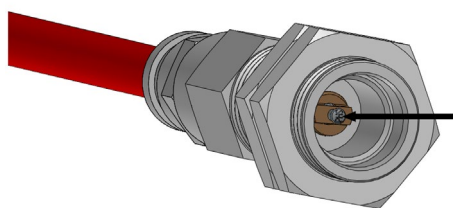

Schrader valve inside the end-of-line adapter

3. Disconnect the BlazeTube detection from the connector on the cylinder valve. Disconnect the BlazeTube by pushing the ring inwards in the place of entry of the tube to the connector and remove the tube. Proceed according to the instructions in Chapter 7.3, also when disconnecting the end-of-line adapter. Be careful, if the tube was under pressure, the pressure will leak from the BlazeTube detection.

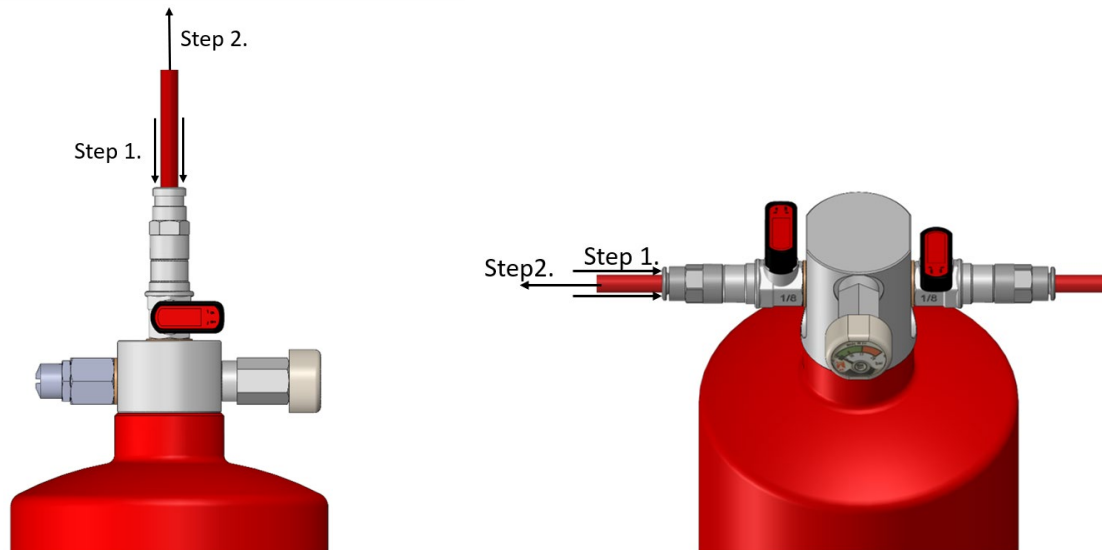

*Disconnection of the BlazeTube detection from the valve
(example: valve 116 and 118 on the left, valve 126 and 128 on the right)*

4. Fasten the new BlazeTube detection properly to the connector of the cylinder valve. Fasten the BlazeTube detection so that the tube is slotted to the connector and pushed by hand all the way. After slotting always make sure by pulling that the tube is firmly gripped.
- 5.
6. Place the BlazeTube detection in the protected enclosure and gradually fasten with clamps/ties.
7. During installation proceed further according to Chapter [7.3](#).
8. Pressurize the BlazeTube detection, proceed according to Chapter [7.4](#).
9. When using systems with HFC-227ea after replacement of the BlazeTube detection have inspection performed and take measures against leaks of HFC-227ea gas according to Chapter [6.6](#).

12.4 CLEANING THE SYSTEM

During maintenance of BlazeCut system clean the surface of the cylinder and the cylinder valve and the tubes from major dirt with appropriate cleaning textiles or cloths and nonaggressive cleaning products.

Do not use aggressive cleaning products such as solvents and caustic to clean the system.

Do not expose the system and especially its electronic parts to direct effect of water pressure during cleaning of the protected enclosure with high-pressure water.

12.5 DECLARATION OF CONFORMITY

Upon installation of each piece of the system the Commissioning/Installation Report must be prepared. Send the original of the Report to the manufacturer of the system. Keep the copy of the original.

Records on the maintenance and inspection of the system indicating the scope of service must be kept. Keep the maintenance records.

Declaration of conformity is issued by the manufacturer for each of the systems separately. The basis and requirement to issue the declaration of conformity is the Report issued by the authorized qualified person with relevant professional qualification in accordance with the relevant legislation and delivered to the manufacturer, whereby the authorized person certifies correct installation of the system pursuant to the technical documentation.

In the declaration of conformity, the manufacturer declares that the equipment under pressure is in conformity with the certificate of the type of the equipment under pressure issued in accordance with the requirements of European directive 2014/68/EU, Module B+E.

Supervising the implementation of the obligations arising out of the approved quality assurance system is ensured by notified body:

AUTOMATIC FIRE SUPPRESSION SYSTEMS



Technická inšpekcia, a.s., Trnavská cesta 56, 821 01 Bratislava, Slovak Republic (NB 1354).

Pursuant to the abovementioned, the equipment under pressure is labelled with CE conformity mark and identification code of notified body: 1354.

The products are safe when the terms of use and technical requirements are observed.

A copy of the current certificates can be requested by emailing technical@blazecutgroup.com

13 PRODUCT TRAINING



Installation of the system, its activation and repair and maintenance is governed by specific legislation and these activities may only be performed by persons with relevant professional qualification subject to applicable legislation. Depending on procedure, also a relevant training or authorization by the manufacturer is required. Unprofessional interference with the system may cause malfunction of the system and provides danger to safety and health of people.

All people installing and servicing the BlazeCut systems must pass a training module for respective type of BlazeCut system. The BlazeCut DLP C Series system training module consists of these main topics:

- Components of the system and accessories
- System functions
- Installation
- Maintenance and servicing

The training is delivered in person, or in online form. After training completion, attendees receive a Training Certificate confirming the completion of respective training module.

Training shall be renewed at least every 5 years.

14 LIST OF ANNEXES

[ANNEX 1: SIGNALLING DEVICES](#)

[ANNEX 2: PRESSURE MONITORING AND ELECTRICAL COMPONENTS](#)

ANNEX 1: SIGNALLING DEVICES

A1.1. SIGNALLING UNITS

Table 42: Signalling units

Part No	Type	Description
ASU001	sound and light signalling unit	81 dB, CE, 6 - 28 V DC, CE exceeds EN54-3; suitable for indoor, fixed, low vibration installations
ASU002	sound and light signalling unit	high base, 114 dB, IP44, EN54-3/CE/LPCB, 24 V DC, CE exceeds EN54-3; suitable for indoor, fixed, low vibration installations
ASU003	sound and light signalling unit	high base, 101 dB(A), IP65, 18-24 V DC, CE exceeds EN54-3; suitable for indoor, fixed, low vibration installations
ASR001	sounder	multitone with high base, 92 – 112 dB, IP65, CE/VdS, LPCB, 9 – 15 V DC, CE exceeds EN54-3; suitable for indoor, fixed, low vibration installations
ABR001	red xenon beacon	IP65, CE, VdS, 9 – 60 V DC, CE exceeds EN54-3; suitable for indoor, fixed, low vibration installations
ABR002	red led beacon	IP65, CE, R10, 12-24 V DC, -20 to +50 °C, 3 bolt mounting; suitable for outdoor mobile applications
ASB001	sounder	97 dB, IP65, SAE J994 Type C, AMCA, UL, CE, E, 12 – 24 V DC, -40 to +85 °C; suitable for outdoor mobile applications
AWB012	warning buzzer	red LED dots, 12V DC, 80 dB (@1 m), IP54. -20 to +50 °C, stainless steel; suitable for fixed and mobile installations; includes ALA019 label
AWB024	warning buzzer	red LED dots, 24 V DC, 80 dB (@1 m), IP54. -20 to +50 °C, stainless steel; suitable for fixed and mobile installations; includes ALA019 label



ASU001



ASU002



ASU003



ASR001



ABR001



ABR002



ASB001



AWB012 and AWB024

A1.2. ALARM PANEL

Table 43: Alarm panel and accessories

Part No	Type	Description
AAP210	alarm panel	without a fire button for C Series, fully configurable via Wi-Fi, data logging, 9 - 36 V DC, 85 dB, IP67, CE, EMC tested, integrated relay, red anodized aluminium body, 55 mm diameter.
AAP310	alarm panel	without a fire button for C Series, preconfigured from factory, data logging, 9 - 36 V DC, 85 dB, IP67, CE, EMC tested, integrated relay, red anodized aluminium body, 55 mm diameter. Can be used for: a) C Series with just one pressure switch b) as a fire warning device
APB210	panel bracket	stainless steel, for AAP210, AAP310 Alarm Panels
ABP212	back-up power supply	12 V for AAP alarm panels, includes 1 x 7.0 Ah battery, for indoor use only
ABP224	backup power supply	24 V for AAP alarm panels, includes 2 x 7.0 Ah battery, for indoor use only
ACF001	fuse case	case for external fuse for Alarm Panels AAP210, AAP211 and AAP310
AEF002	fuse	external fuse 2 A for Alarm Panels AAP210, AAP211 and AAP310



AAP310



APB210



ABP212



ABP224



ACF001



AEF002

Table 44: Alarm panel kits

Part №	Content
KAAP210	Alarm Panel AAP210 without a fire button, Panel Bracket APB210, 12-pin Connector ADC012, 8x Sealing Plug ADP001, Fuse AEF002, Fuse Case ACF001, 2x End-of-line Resistor AER101, labels ALA004 and ALA005
KAAP310	Alarm Panel AAP310 without a fire button, Panel Bracket APB210, 6-pin Connector ADC006, 2x Sealing Plug ADP001, Fuse AEF002, Fuse Case ACF001, End-of-line Resistor AER101, labels ALA004 and ALA005



For additional information ask for APM210-310-EN – ALARM PANEL MANUAL.

ANNEX 2: PRESSURE MONITORING AND ELECTRICAL COMPONENTS

A2.1. PRESSURE TRANSDUCER ATA100

Pressure Transducer ATA100 provides full range constant pressure monitoring in the system. It can identify a low pressure or overpressure in the system and notify the operator through an Alarm Panel or other external device.

Depending on the valve type, the Pressure Transducer ATA100 can be installed to the system in several ways described in Chapter [A2.1.1](#).

Table 45: Specifications of pressure transducer ATA100

Parameter	Description
Material of body	stainless steel
Pressure range	0 – 40 bar
Accuracy	0.5 % BFSL
Maximum overpressure	80 bar
Operation voltage	8 – 30 V DC
Power consumption	8 mA
IP rating	IP67
Operation temperature	from -40 °C up to 70 °C
Thread	M10x1 (14 mm with O-ring and filter)
Electrical cable	25 cm length, 3 x 0.75 mm ²



Pressure Transducer ATA100

A2.2. PRESSURE SWITCH APS001-xx

Pressure Switch APS001-xx is a mechanical switch with one pre-set pressure value (switch point). When the pressure in the system drops below the switch point, the pressure switch sends a signal to an Alarm Panel or an external device to perform the operation. The pressure switch is supplied with a cable connector.

The Pressure Switch APS001-xx will send a signal when the pressure in the system decreases regardless of the cause, in case of fire or accidental activation and rapid decrease of pressure in the system which is below the pre-set value.

Depending on the valve type, the Pressure Switch APS001 can be installed to the system in several ways described in Chapter [A2.1.1](#).

Table 46: Specifications of pressure switch APS001-xx

Parameter	Description		
Material of body	nickel plated steel		
Hysteresis	min. 0.5 bar, max. 1.5 bar		
Switching frequency	max. 100 min ⁻¹		
Power rating	Voltage	Current	
Resistive load AC-12, DC12	AC 250 V	DC 24 V	4 A
Inductive load AC-14, DC14	AC 250 V	DC 24 V	2 A
IP rating	IP65 with cable connector and seal		
Electrical outlet	DIN EN 175301-803 A		
Operation temperature	from -30 °C up to 100 °C		
Thread	M10x1 (12.5 mm with O-ring and filter)		



Pressure Switch APS001-xx

Table 47: Versions of APS001-xx for clean agents

Part №	Suitable for	Switch point	Pressure value
APS001-5	HFC-227ea	Fire indication	5
APS001-7	HFC-227ea	Low pressure	7
APS001-9	FK-5-1-12	Fire indication	9
APS001-11	FK-5-1-12	Low pressure	11

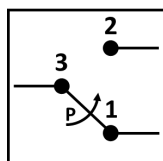

When supplied and before pressurized (before connected to the valve or end-of-line adapter)

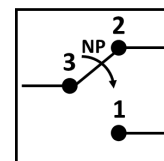

After being connected to the valve or end-of-line device with the system pressurized.

A2.1.1. INSTALLATION OF PRESSURE MONITORING COMPONENTS

Pressure monitoring components such as pressure transducers, pressure switches and additional pressure gauges are usually delivered not installed, to prevent them from damaging during transportation. All pressure monitoring components are compatible with M10x1 ports. The M10x1 ports are sealed by a Schrader valve, which closes and opens automatically during removal or installation of the components. The Schrader valve allows to perform these operations even when the system is under pressure. The same principle of sealing is also used on end-of-line adapters and M10x1 adapter FVABM0210 on the cylinder valve.

For valves 126 and 128 at the time of order, a valve adapter FVABM0210 can be requested to allow for additional M10x1 port for pressure monitoring components.

Suitable outlets for individual components:

Valves 116 and 118

1. Valve Adapter FVABM0210
 - a) main pressure gauge
2. End-of-line Adapter AEA006 on a BlazeTube
 - a) additional pressure gauge
 - b) Pressure Transducer ATA100
 - c) Pressure Switch APS001

Valves 126 and 128

1. Top Valve Adapter FVABM0210
 - a) main pressure gauge
 - b) Pressure Transducer ATA100
 - c) Pressure Switch APS001
2. Bottom Valve Adapter FVABM0210 (optional component)
 - a) main pressure gauge
 - b) Pressure Switch APS001 for low pressure monitoring
3. End-of-line Adapter AEA006 on a BlazeTube
 - a) additional pressure gauge
 - b) Pressure Transducer ATA100
 - c) Pressure Switch APS001 for fire indication

IMPORTANT!

Main pressure gauge must always be installed in the appropriate port on the cylinder valve. It can be uninstalled only momentarily, during maintenance or gauge relocation.

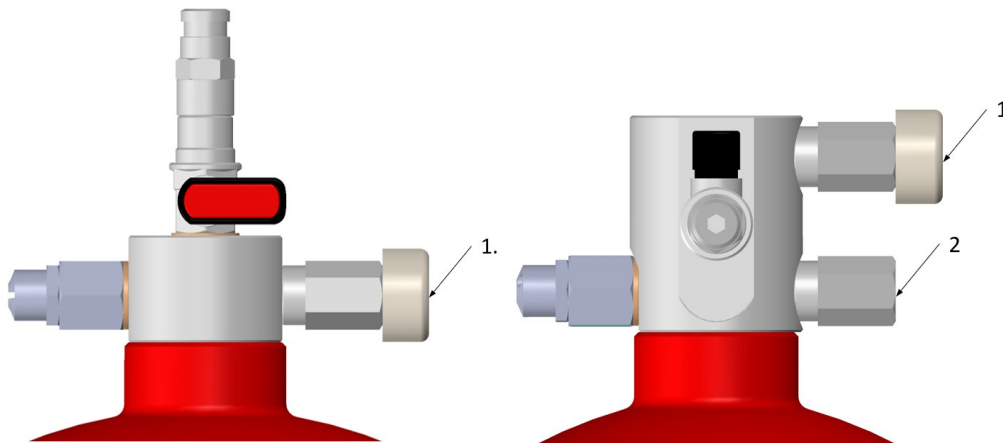

M10x1 ports on valves 116, 118 (left) and valves 126, 128 (right)

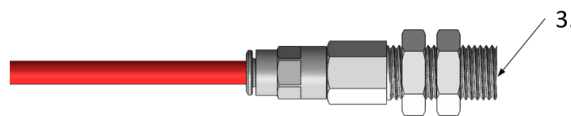

Additional M10x1 port on the end-of-line adapter

A2.1.2. WARNINGS



Install the pressure switch and pressure transducer so that it is not exposed to aggressive chemical substances (caustic, acids, solvents, corrosive substances etc.) and to direct influence of weather conditions.



Always place the pressure switch and pressure transducer in the lower part of the risk area to avoid direct flames and heat. The pressure switch cannot be in direct contact or be in immediate proximity with parts which heat to temperatures of more than 80 °C (176 °F) e.g., engine block, engine turbocharger, exhaust pipe, heated parts of inductors etc.



Be aware of the danger posed by the protected device. When working in the vicinity of electrical equipment observe corresponding safety rules and instructions. Work on electrical installations may be performed only by qualified persons.

AUTOMATIC FIRE SUPPRESSION SYSTEMS



In case a pressure transducer, pressure switch or a pressure gauge has to be uninstalled from the cylinder valve, depressurization of the cylinder is **not** required. Follow these steps when installing or uninstalling components into the cylinder valve:

1. Uninstall (fully unscrew) the desired component. A small amount of extinguishing agent may be released from the port.
3. Install the new component. To properly install it and prevent any malfunctions of the system, screw in the component tightly.
4. Pressurize the system as described in Chapter [8.3](#) and check for presence of any leaks.

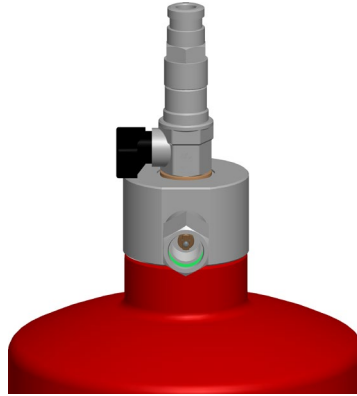

M10x1 port with exposed Schrader valve after component uninstallation

NOTE:

In case of malfunction or disconnection of the electrical components (Pressure Switch APS001-xx, Pressure Transducer ATA100, electrical installation) the system remains functional, these components are not necessary for its automatic activation in case of fire.

A2.3. ELECTRICAL CABLES, CONDUITS AND CONNECTORS

For installation of electrical components use the appropriate electrical cables supplied as optional components:

- Pressure Transducer ATA100 – two core electrical cable;
- Pressure Switch APS001-xx – two, three or four core electrical cable.

Table 48: Specifications of cables

Part №	Description	Comment	Length
ASC002	standard cable, 2x0.75 mm ² , -40°C up to 80 °C, UV stabilized	for standard installations	per metre
ASC004	standard cable 4x0.5 mm ² , -40°C up to 80 °C, UV stabilized	for standard installations	per metre
ASC102	silicone cable 2x0.75 mm ² , -60 °C up to 180 °C, UV stabilized, up to 500 V	for installations with high temperatures like in engine compartments	per metre
ASC103	silicone cable 3x0.50 mm ² , -60 °C up to 180 °C, UV stabilized, up to 500 V	for installations with high temperatures like in engine compartments	per metre
ASC104	silicone cable 4x0.50 mm ² , -60 °C up to 180 °C, UV stabilized, up to 500 V	for installations with high temperatures like in engine compartments	per metre



Standard cable



Silicone cable

Table 49: Silicone cable kits

Part No	Description
KASC102-005	2-core silicone cable kit, 5 metres, 15 cable ties, -60 °C up to 180 °C
KASC102-010	2-core silicone cable kit, 10 metres, 30 cable ties, -60 °C up to 180 °C
KASC102-015	2-core silicone cable kit, 15 metres, 45 cable ties, -60 °C up to 180 °C
KASC102-020	2-core silicone cable kit, 20 metres, 55 cable ties, -60 °C up to 180 °C
KASC103-005	3-core silicone cable kit, 5 metres, 15 cable ties, -60 °C up to 180 °C
KASC103-010	3-core silicone cable kit, 10 metres, 30 cable ties, -60 °C up to 180 °C
KASC103-015	3-core silicone cable kit, 15 metres, 45 cable ties, -60 °C up to 180 °C
KASC103-020	3-core silicone cable kit, 20 metres, 55 cable ties, -60 °C up to 180 °C
KASC104-005	4-core silicone cable kit, 5 metres, 15 cable ties, -60 °C up to 180 °C
KASC104-010	4-core silicone cable kit, 10 metres, 30 cable ties, -60 °C up to 180 °C
KASC104-015	4-core silicone cable kit, 15 metres, 45 cable ties, -60 °C up to 180 °C
KASC104-020	4-core silicone cable kit, 20 metres, 55 cable ties, -60 °C up to 180 °C

In case of installation in spaces with increased risk of damage due to mechanical interference use the cable conduit with conduit connector to protect the electrical cables.

Table 50: Specifications of conduits

Part No	Description	Length
ACC110	Cable conduit, internal Ø 10 mm, -40 °C to 120 °C	per metre



Cable conduit ACC110

Table 51: Specifications of electrical connectors

Part No	Description	Working temperature
ADP001	sealing plug for Deutsch connectors	-55 °C to +125 °C
ADC002	2-pin Deutsch connector	
ADC006	6-pin Deutsch connector	
ADC012	12-pin Deutsch connector	



ADP001

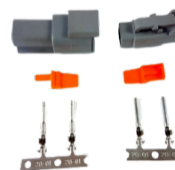

2-pin Deutsch connector

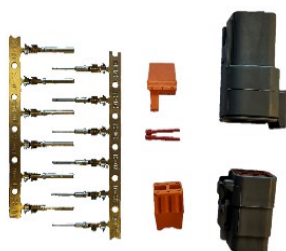

6-pin Deutsch connector

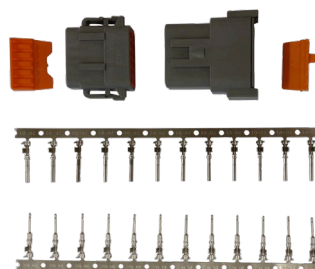

12-pin Deutsch connector

