

AHD MOBILE DVR

Hardware User Manual

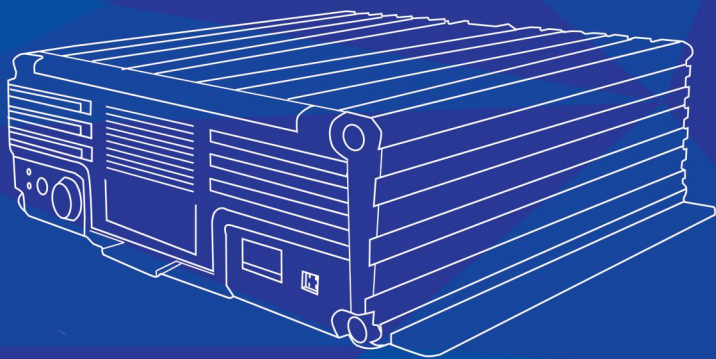

Catalogue

Chapter 1 Accessories and Interface	1
1. MDVR and accessories	1
2. System connection	2
3. Panel introduction	3
4. Interfaces Definition	3
4.1 Power interface	3
4.2 I/O Interface definition	4
4.3 Aviation interface definition	4
Chapter 2 Installation and Application	4
1. HDD,SD card and SIM card installation	4
2. Antennas Connection	6
3. Power Connection	6
4. Camera Connection	6
5. Monitor connection	7
6. I/O wires connection	8
6.1 IR extension connection	8
6.2 Alarm input connection	8
6.2.1 Application of Alarm input(Reverse assistant)	9
6.2.2 Application of Alarm Input(Emergency Alarm)	11
6.3 Serial ports connection	12

Chapter 1 Accessories and Interface

1. MDVR and accessories

Before you use this product please check the accessories in the packing box. If there is anything missing or damaged please contact your seller. The MDVR and accessories are listed as following:

Description	Picture	Quantity
MDVR		1
Power cable		1
I/O cable	 (Truck) (Car)	1
Input & Output cable		1
Key		2
3G/4G antenna (Optional)		1
GPS antenna (Optional)		1
WIFI(Optional)		1
Mouse (Optional)		1
Speaker handset (Optional)		1

2. System connection



3. Panel introduction

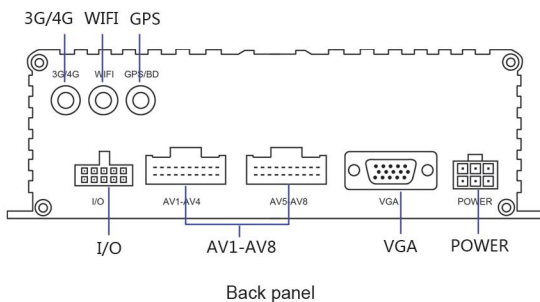
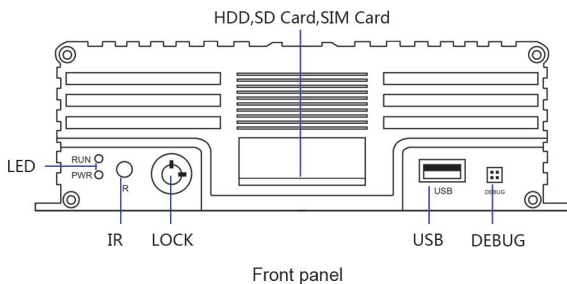

4. Interfaces Definition

Here we introduce the definition of the interfaces of Power, I/O, AV Input & Output. See as following:

4.1 Power interface

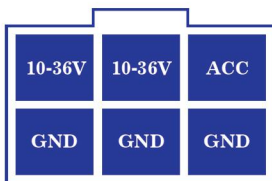

Power interface definition

4.2 I/O Interface definition

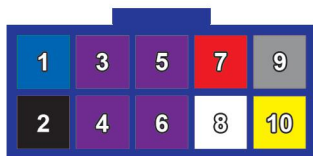

Front view of I/O Interface

PIN	Definition	PIN	Definition
1	Alarm output	2	Ground
3	Alarm input 2(Positive)	4	Alarm input 1
5	Alarm input 4(Positive)	6	Alarm input 3
7	5V Output	8	TXD(TTL Level)
9	IR Extension	10	RXD(TTL Level)

I/O Interface definition

4.3 Aviation interface definition



AV-IN Camera Interface

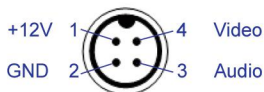

AV-OUT Monitor Interface

Chapter 2 Installation and Application

1. HDD,SD card ,SIM card installation



Please insert the key into the hole of the lock on the front panel, and switch it to be open status.



Rotate the mounting screws of the hard disk bracket counterclockwise, and remove the hard disk bracket from the outside after removing the screws.

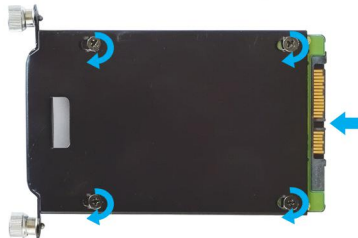

Insert the hard disk into the bracket and secure the 4 fixing screws. (Fixing screw in the accessory box)



Hard disk installation: insert the bracket of the hard disk into the case and lock the fixed screws on both sides PIN foot contacts are oriented down into the case, and the SIM card chip contacts downward toward the case. After Hard disk, SD card and SIM card are fixed, close the front plate and lock the hard disk lock.

2. Antennas Connection

Please connect the WiFi and GPS antennas as per the picture as followed. We suggest you put the GPS antenna externally at the vehicle's roof to make sure signal connection even when it is weak.



Antennas Connection

3. Power Connection

Please connect the power as per the definition of power interface. Positive pole (RED) connects with power input 10-36V DC, ACC ignition (YELLOW) connects with 5-36V DC.

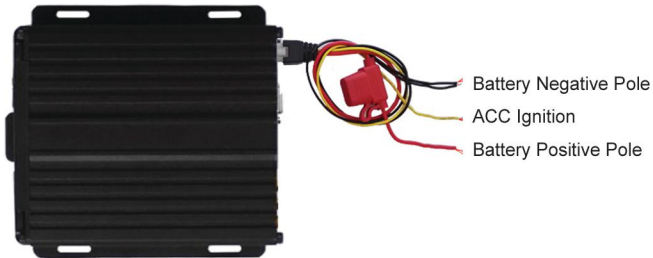

Power Connection

The yellow ignition wire is used to detect the ignition signal. We strongly suggest you connect it with the "RUN" terminal of the ignition switch, or any terminal in the vehicle's switch box which will have power only when the vehicle was ignited (f.g. the FM radio)

PS: When testing the device, please connect both of the red power wire and the yellow ignition wire with the positive pole of the UPS, otherwise, the device will not boot.

4. Camera Connection

You can connect the camera with the AV input cable directly, or by extension cable (optional). The AV cable in the accessories box has mark on each connector, AV 1-8 are for cameras connection.



PS: Before you connecting the cameras, please double check the definition of the AV interface, please make sure your cameras are with same aviation interface definition with the DVR.

5. Monitor connection

The device supports VGA and CVBS output. You can switch the output mode to be the one you need by the mouse or remote control.



PS: Before you connecting the monitor, please double check the definition of the AV interface, please make sure your monitor is with same aviation interface definition with the DVR.

6. I/O wires connection

When you're going to use it, please connect the wires as the I/O interface definition. You will also find tips of the interface definition in the DVR menu.

6.1 IR extension connection

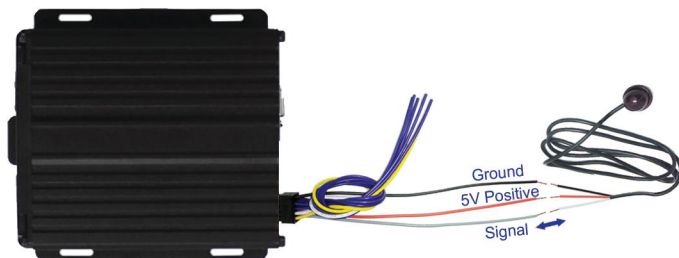

IR extension connection

I/O wires			IR extension cable	
PIN	Definition		Color	Definition
2	Ground	↔	Black	Ground
7	5V Output	↔	Red	5V Power
9	IR Extension	↔	White	Signal

IR Connection

6.2 Alarm input connection

This device provides 4 channels alarm inputs (2 channels positive trigger, 2 channels negative/positive trigger). You can connect the positive pole of circuit of the reverse light, turn light, door open & close etc with them for applications such as reverse assistant, camera channels switching. You can also connect it with the SOS emergency button for alarm linkage.

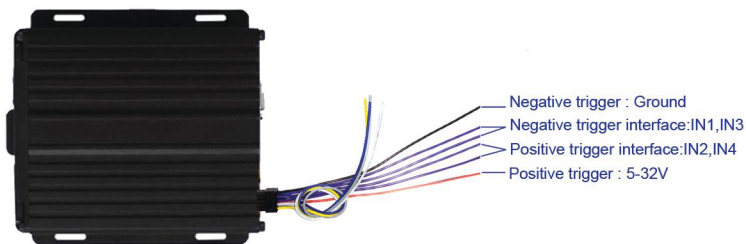

Alarm Input Connection

I/O wires			Alarm Trigger	
PIN	Definition		Color	Alarm trigger
3	Alarm input2	↔	Red	5-32V
5	Alarm input4			
4	Alarm input1	↔	Black/Red	Ground/5-32V
6	Alarm input3			

Alarm input Connection

6.2.1 Application of Alarm input (Reverse assistant)

The device comes with Reverse assistant feature, give an example with Alarm Input2, we connect the wire of alarm input 2 with the positive pole of reverse light's power, see as following:

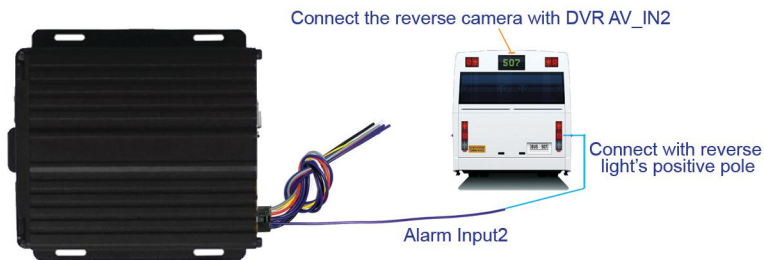

Reverse Assistance Connection

I/O wires			Alarm trigger	
PIN	Definition		Color	Alarm Trigger
3	Alarm input 2	↔	Red	Positive pole of Reverse light

Reverse Assistance Connection

Setup it in the DVR menu "Advanced" → "RearCamera", see as following, click "OK" to save your setting.

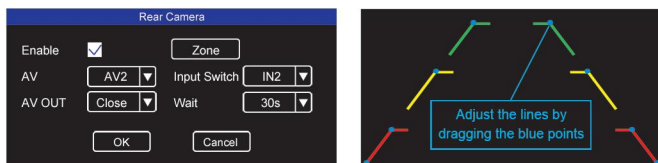

AV: Please select the reverse camera's channel

InputSwitch: Please select the alarm input number which connect with the reverse light's power

PS: When using reverse assistance, please use IN2, IN4 positive trigger to setup

When you put reverse gear, the DVR will display the reverse camera's channel only. See as following:



Reverse Assistance

6.2.2 Application of Alarm Input (Emergency Alarm)

You can connect an Emergency Button With the alarm input of the device. When you hit the Emergency alarm button, the device will send alarm information to the server platform. That is alarm linkage. (This application requests the DVR connecting with the server in real time, otherwise, the server platform will not receive the alarm information). We give an example with Alarm Input 1, connect the I/O alarm input wire 1 with one terminal of the Emergency button, and connect the other terminal of the Emergency button with ground.

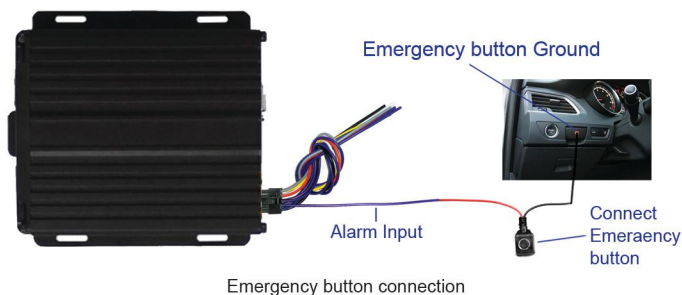

PS: (If the connected Alarm input is Positive trigger, the other end of the Emergency button will be 5-32V DC power)

Setup it in the DVR menu “Alarm” → “Input”, select AlarmInput1 in the list to setup the alarm parameter. See as following:

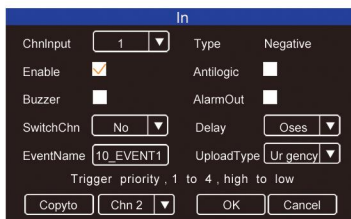

Setup alarm input

ChnInput: This channel is used to connect with the Emergency button.
 UploadType: When you use the emergency button, please set up it to be “Urgency”, otherwise, set up it to be “No”

6.3 Serial ports connection

The device provides a group of serial ports which are used to connect with some user’s peripherals, the interface is LVTTTL (3.3V) level

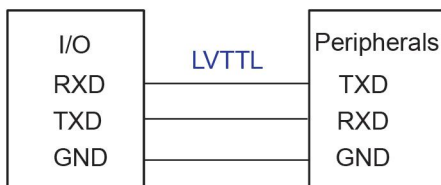

Serial ports Connection

I/O wires			Peripherals	
PIN	Definition		Color	Definition
2	Ground	↔	Black	Ground
8	TXD(TTL level)	↔	Yellow	RXD
10	RXD(TTL level)	↔	White	TXD

Serial ports connection