

Maahantuoja:



Oy Kaha Ab
Ansatie 2
01740 Vantaa

www.kaha.fi
teollisuus@kaha.fi
puh 09 615 6800

Myynti
puh 09 615 68300
fax 09 615 68301

Tuotteet www.autoluettelo.fi



RAM[®] MOUNTS

Material Handling



ABOUT RAM® MOUNTS

RAM® Mounts manufactures rugged and versatile mounting systems for cameras, tablets, and other mobile devices that can be attached nearly anywhere. Unlike other mounts on the market, RAM® allows you to secure devices where you need them most. The unique design of the RAM® Mounts system provides quick installation, adjustability, strength, vibration damping, and durability—all at a low cost. Backed by a lifetime warranty, RAM® uses powder-coated, marine-grade aluminum with lightweight and high-strength composites, stainless steel hardware, and rubber balls.

THE RAM® DIFFERENCE

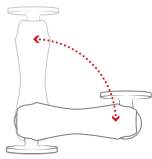

PREMIUM DESIGN

The rubber ball and socket design of our mounting systems offers a secure hold, with near-infinite adjustability and vibration damping for the most demanding environments. With thousands of components trusted by users around the world, we've been able to design and develop mounting solutions that consumers and companies previously only dreamed were possible.

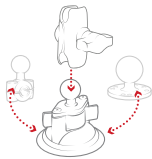

CUSTOMIZABLE

Take your phone mount from your truck to your boat, or mix and match components to create your ideal mount. Because of the modularity of the RAM® system, you can customize your solution to fit your specific needs in almost any application.

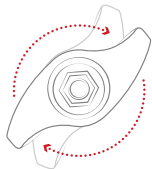

QUALITY MATERIALS

A premium design deserves the highest quality materials available, from rubber and stainless steel to high-strength composites and marine-grade aluminum. Our facilities—including powder coating, die casting, rubber injection molding, and shock and vibration testing—help us deliver on this promise to bring you inventive mounting solutions.

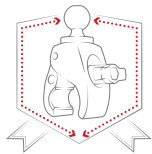

LIFETIME WARRANTY

It's simple. Our reputation as the leader of premier mounting systems means if we build it, then we guarantee it. We're confident in the quality of our products, and with our warranty, you can be too.

NATIONAL PRODUCTS INC. (NPI)

Introduced in 1995, National Products Inc. (NPI) quickly became the leading manufacturer of rugged and versatile mounting solutions. RAM® Mounts has grown to offer approximately 5,000 modular components—the most innovative product line of its kind for nearly any application and device, including phones, tablets, GPS systems, laptops, marine electronics, printers, radios, and much more.

In addition to RAM® Mounts, NPI is also the creator of award-winning IntelliSkin® sleeves and GDS® Technology™ products. IntelliSkin® sleeves ruggedize a wide range of consumer phones and tablets, while the GDS® Ecosystem™ provides users the ability to securely charge, dock, and sync devices in the most demanding environments.

Backed by more than 400 employees, NPI is proudly located in Seattle, Washington in the same neighborhood where the company was started.

PARTNER WITH RAM® MOUNTS

Here at RAM® Mounts, we believe that unfathomable things are possible with ingenuity. With a portfolio of more than 5,000 SKUs paired with innovative engineers and in-house product experts, we have the tools and expertise needed to create solutions that you didn't know were possible. We have the ability to solve your mounting challenges quickly, efficiently, and cost effectively.

OEM:



RESELLERS:



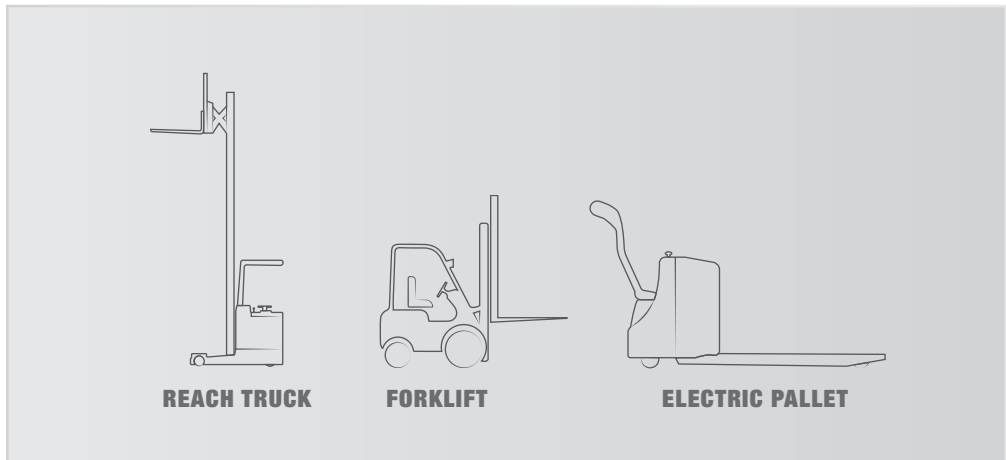

TABLE OF CONTENTS



05 POPULAR MOUNTING LOCATIONS

07 BALL, SOCKET & ARM SIZES

08 HOW IT WORKS

09 DEVICE HOLDERS / ADAPTERS

- 10 Monitors & Computers
- 11 Handheld PCs
- 13 Sonim XP5S / XP8
- 14 Samsung Galaxy XCover Pro
- 15 Samsung Galaxy Tab Active2
- 17 Samsung Galaxy Tab Active Pro
- 19 Tablets & Tablet PCs
- 21 IntelliSkin® with GDS® Tech™
- 25 GDS® Desktop Docks
- 26 GDS® Slide Dock™
- 27 GDS® Ecosystem™
- 29 GDS® Ergo™ & Power Accessories
- 31 Scanner Gun Holders
- 33 Printer Cradles
- 33 Universal Holders
- 34 Phone Holders

35 BASES

- 36 Overhead Guard Plates
- 37 Square Post Clamp
- 39 Round Post Clamp
- 40 Crown Work Assist®
- 40 U-Bolt
- 41 Drill-Down
- 43 RAM® Tough-Mag™
- 44 Strap Hose Clamp
- 44 RAM® Tough-Claw™

45 SWING ARM POST CLAMPS

49 ACCESSORIES

- 50 RAM® Hi-Torq™ Wrench
- 50 RAM® Pin-Lock™ Security Knob and Key
- 50 Keyed Locking Knob
- 51 RAM® Shock Buster™ Adapter
- 53 RAM® Handi-Case™
- 54 RAM® Multi-Pad™

55 THINK OUTSIDE THE WAREHOUSE

59 COMPATIBILITY GUIDE

65 PRODUCT CHARTS

70 THE SHAPE THAT STARTED IT ALL



POPULAR MOUNTING LOCATIONS

Using RAM® Mounts, there are a wide range of mounting solutions and mounting locations for forklifts and other equipment in material handling settings. This catalog will help you find compatible mounting systems for overhead guards, square posts, and any location appropriate for mounting a drill-down base.



1 Overhead Guard Plates pg. 36
 Socket Arm pg. 7
 Device Adapter pg. 9



2 Overhead Guard Plates pg. 36
 Socket Arm pg. 7
 Device Adapter pg. 9

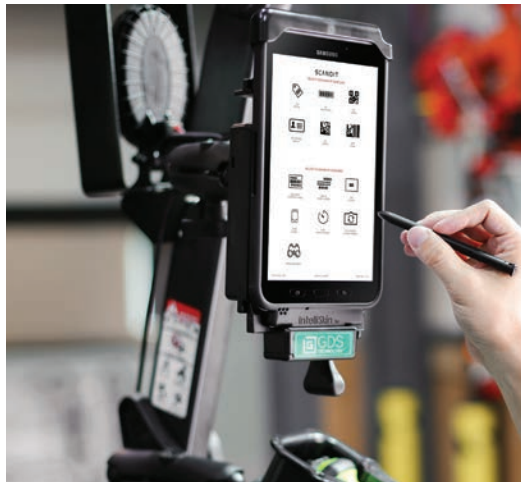

3 Square Post Clamp pg. 37
 Socket Arm pg. 7
 IntelliSkin® with GDS® Tech™ pg. 21



4 Square Post Clamp pg. 37
 Socket Arm pg. 7
 Scanner Gun Holder pg. 31

BALL & SOCKET SIZES

Each ball size in the RAM® Mounts rubber ball and socket system supports a different amount of weight and withstands increasingly intense vibration. Use the examples below to determine the ideal size for your system based on your device weight and application.



B SIZE

- 1" diameter ball
- Holds up to 1 lb
- Ideal for cup holders, cameras, phones, and other lightweight devices



C SIZE

- 1.5" diameter ball
- Holds up to 3 lbs
- Ideal for tablets, 2D barcode scanners, and lightweight laptops



D SIZE

- 2.25" diameter ball
- Holds up to 5 lbs
- Ideal for vehicle-mounted computers and rugged laptops in moderate vibration environments



E SIZE

- 3.38" diameter ball
- Holds up to 10 lbs
- Ideal for vehicle-mounted computers and rugged laptops in extreme vibration environments

ARM SIZES

RAM® Mounts feature a double ball and socket system, providing modularity and adjustability. A RAM® arm is the connection between the mounting base and your device, and are available in multiple sizes and lengths.



B SIZE 1"

PART NUMBER	OVERALL LENGTH	SOCKET TO SOCKET
RAM-B-201U-A	2.42"	1.75"
RAM-B-201U	3.73"	3.00"
RAM-B-201U-C	6.00"	5.31"



C SIZE 1.5"

PART NUMBER	OVERALL LENGTH	SOCKET TO SOCKET
RAM-201U-B	3.56"	2.50"
RAM-201U	5.69"	4.66"
RAM-201U-D	9.13"	8.00"



D SIZE 2.25"

PART NUMBER	OVERALL LENGTH	SOCKET TO SOCKET
RAM-D-201U-C	5.10"	3.60"
RAM-D-201U	8.44"	6.88"
RAM-D-201U-E	12.98"	11.41"



E SIZE 3.38"

PART NUMBER	OVERALL LENGTH	SOCKET TO SOCKET
RAM-E-201U-D	7.31"	4.97"
RAM-E-201U	12.625"	9.875"

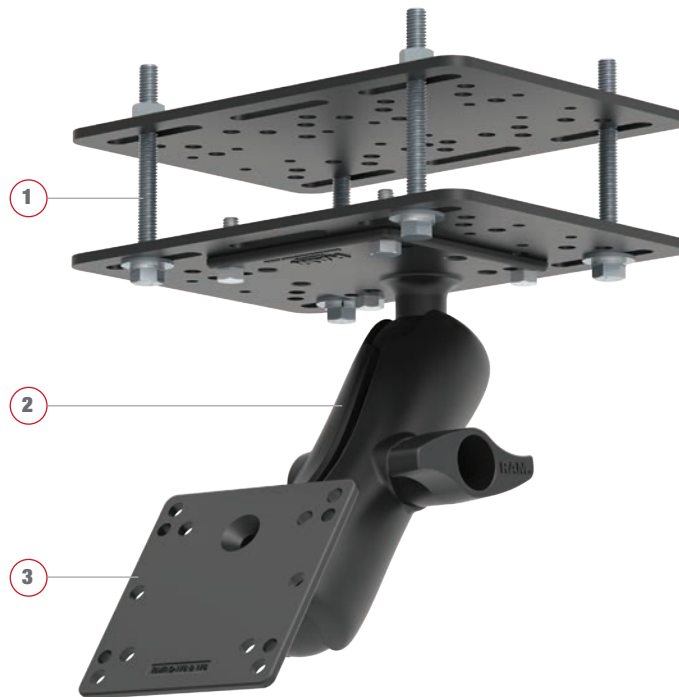

HOW IT WORKS

- 1 CHOOSE A BASE**
 Select from a variety of bases to help secure your device where you need it.
- 2 CHOOSE AN ARM**
 Select an arm based on your desired length and placement.
- 3 CHOOSE AN ADAPTER**
 RAM® offers a wide selection of adapters and cradles for your specific device.
- 4 CHOOSE A HOLDER**
 RAM® offers a wide selection of holders for your specific device.



SEE PAGE 68 FOR ALL
BALL PLATE ADAPTERS



1

DEVICE HOLDERS/ADAPTERS



SEE PAGE 68 FOR ALL
BALL PLATE ADAPTERS



MONITORS & COMPUTERS

TAKE ADVANTAGE OF THE RAM® BALL AND SOCKET SYSTEM

RAM® square, round, and diamond ball plates are ideal mounting solutions for a wide variety of monitors and computers. Each plate features industry-standard hole patterns as well as a RAM® rubber ball compatible with RAM® double socket arms for the perfect placement of your device.

FEATURES

- Ball bases available in square, round, and diamond shapes for a variety of devices
- Varying RAM® rubber ball sizes are compatible with corresponding RAM® double socket arms
- Made of powder-coated, marine-grade aluminum
- Bases include industry-standard hole patterns

-
1. RAM-247U-25, Square Post Clamp with 1.5" Ball
RAM-201U, Standard Socket Arm for 1.5" Ball
RAM-202U, AMPS Device Adapter with 1.5" Ball (shown with AML Guardian)
 2. RAM-246U, RAM® 100x100mm VESA Plate with Ball
 3. RAM-B-238U, RAM® Diamond Ball Base
 4. RAM-202U, RAM® Round Plate with Ball
 5. RAM-D-202U, RAM® Large Round Plate with Ball

+ SEE PAGE 62 FOR
**HANDHELD PC
COMPATIBILITY GUIDE**





1



**HANDHELD PC
POWERED
FORM-FIT HOLDERS**

Easy to insert and remove from the spring-loaded cradle, your handheld PC is kept safe, secure, and powered with these form-fit holders. Each Zebra, Panasonic, and Honeywell holder ensures your device's USB, power, and serial ports remain fully functional in the most demanding environments.

AVAILABLE IN:

- 



- 



1. RAM-H0L-ZE7U, RAM® Form-Fit Powered Cradle for Zebra TC70, 72, 75 & 77
RAM-238U, RAM® Diamond Ball Base
RAM-201U, RAM® Double Socket Arm
RAM-MAG88U, RAM® Tough-Mag™ 88MM Diameter Ball Base
2. RAM-H0L-H0N7CLU, RAM® Powered Combo Locking Spring Loaded Cradle for Honeywell CT50 & CT60
3. RAM-H0L-H0N7KLU, RAM® Powered Keyed Locking Spring Loaded Cradle for Honeywell CT50 & CT60
4. RAM-H0L-PAN14U, RAM® EZ-Roll'r™ Cradle for Panasonic FZ-T1
5. RAM-H0L-ZE7LU, RAM® Keyed Locking Power Only Spring Loaded Cradle for Zebra TC70 & TC75
6. RAM-H0L-ZE7CLU, RAM® Combo Locking Power Only Spring Loaded Cradle for Zebra TC70 & TC75

+ SEE PAGE 62 FOR
**HANDHELD PC
 COMPATIBILITY GUIDE**



FEATURES

- Select cradles available in key and combination locking versions
- Compatible with RAM® diamond ball bases for attachment to RAM® double socket arms and mounts
- Cradles ensure access to essential ports and buttons
- 3-year warranty for electronic components

+ SEE PAGE 62 FOR
**HANDHELD PC
COMPATIBILITY GUIDE**



**SONIM
XP5S AND XP8 PHONES**

These spring-loaded powered and locking cradles secure the Sonim XP5s and XP8 phones. Compatible with RAM® two-hole AMPS pattern bases and RAM® microphone brackets, each cradle easily connects to B and C size ball mounts for use in a wide variety of applications. For charging capabilities, users can take advantage of the RAM-GDS-CHARGE-V7BU modular hardwire charger.

AVAILABLE IN:

- | | |
|---|---|
|  LOCKING |  NON-LOCKING |
|  POWER |  NON-POWER |

FEATURES

- 2-hole AMPS mounting pattern compatible with RAM® B and C size bases
- Single-handed docking, locking, and charging of Sonim XP5S and XP8
- Waterproof design
- 3-year warranty for electronic components

1. RAM-H0L-SNM2PLU, RAM® Powered Locking Dock for Sonim XP8
2. RAM-H0L-SNM1PLU, RAM® Powered Locking Dock for Sonim XP5S

+ SEE PAGE 62 FOR
**HANDHELD PC
COMPATIBILITY GUIDE**



INTELLISKIN® WITH GDS® FEATURES

- Protective sleeve features GDS® Technology™ and military-grade drop protection
- GDS® connector and docking contacts provide charging and data sync capabilities
- Compatible with select GDS® Docks™ and accessories
- Backed by a 3-year warranty



XCOVER PRO HOLDERS FEATURES

- RAM® EZ-Roll'r™ cradles allow for easy one-handed docking and removal of the phone
- RAM® EZ-Roll'r™ cradles available in standard and power delivery versions
- Universal options include spring-loaded RAM® X-Grip® and RAM® Quick-Grip™ XL
- Ball and socket technology allows for near-infinite adjustability

**GALAXY
XCOVER PRO
INTELLISKIN® AND
DEVICE HOLDERS**

RAM® EZ-Roll'r™ cradles for the Samsung Galaxy XCover Pro are available in both standard and power delivery versions. To enable charging capabilities, take advantage of the GDS® modular hardware charger. In addition, users can enable the XCover Pro with IntelliSkin®. The exterior of the IntelliSkin® sleeve includes contacts designed for repetitive docking in field applications, making it compatible with the GDS® locking phone dock for secure vehicle charging.

- 3.** RAM-GDS-DOCKL-V3CU, Vehicle GDS® Locking Dock for Phones
- 4.** RAM-GDS-SKIN-SAM59, IntelliSkin® for Samsung XCover Pro
- 5.** RAM-HOL-SAM9PU, RAM® EZ-Roll'r™ Powered Cradle for Samsung XCover Pro
- 6.** RAM-HOL-SAM59U, RAM® EZ-Roll'r™ Cradle for Samsung XCover Pro
- 7.** RAM-HOL-UN10BU, RAM® X-Grip® Large Phone Holder with Ball
- 8.** RAM-HOL-PD4-238AU, RAM® Quick-Grip™ XL Phone Holder with Ball



SEE PAGE 59 FOR
SAMSUNG TAB ACTIVE2
COMPATIBILITY GUIDE



1

GALAXY TAB ACTIVE2
DEVICE PROTECTION &
CHARGING CAPABILITIES

These solutions include a wide range of skins and cradles that provide protection and charging capabilities for the Samsung Tab Active2. In addition to the RAM® Skin™ featuring military-grade drop protection and a built-in S Pen holder, compatible power and data cradles are available in standard, key locking, and combination locking versions.

AVAILABLE IN:



KEY LOCK



COMBO LOCK



NON-LOCKING



POWER



POWER + DATA

1. RAM-H0L-SAM58PKLU, RAM® Powered Key-Locking Cradle
RAM-101U-247-3, RAM® Square Post Clamp Mount for Posts up to 3" Wide
2. RAM-SKIN-SAM29, RAM® Skin™
3. RAM-H0L-SAM58PDCLU, RAM® Power + Data Combo-Locking Cradle, Supports GDS® HandStand™
4. RAM-H0L-SAM58PKLU, RAM® Powered Key-Locking Cradle
5. RAM-DOCK-6G8PU, RAM® Powered 6 Gang Dock
6. RAM-GDS-SS1U, GDS® Shoulder Strap Accessory for IntelliSkin® Products
7. RAM-GDS-HS1U, GDS® HandStand™ Tablet Hand Strap and Kick Stand
8. RAM-GDS-STU, GDS® Wrist Strap for IntelliSkin®

+ SEE PAGE 59 FOR
SAMSUNG TAB ACTIVE2
COMPATIBILITY GUIDE



RAM® SKIN™ FEATURES

- Protective sleeve features military-grade drop protection and a built-in S Pen holder
- Compatible with GDS® HandStand™ and shoulder strap accessories
- Pair with RAM® power and data cradles for charging capabilities
- Backed by a lifetime warranty



LOCKING, POWER, AND DATA DOCKS FEATURES

- Choose from key and combination locking versions with power and data capabilities
- RAM® Mounts Compatible™ with AMPS hole pattern components
- Access to stylus remains while the device is docked
- 3-year warranty for electronic components
- Compatible with factory skin and RAM® Skin™



+ SEE PAGE 60 FOR
SAMSUNG TAB ACTIVE PRO
COMPATIBILITY GUIDE







1

GALAXY TAB ACTIVE PRO
DEVICE PROTECTION &
CHARGING CAPABILITIES

A variety of solutions for the Samsung Tab Active Pro provide protection and charging capabilities—while also being compatible with the GDS® HandStand™ and GDS® shoulder strap accessories. Available in a range of bundles, the RAM® Skin™ features military-grade drop protection and a built-in S Pen holder. In addition, the Next Generation IntelliSkin® protective sleeve combines a hard plastic shell with a soft, shock-absorbing rubber. An integrated USB Type-C connector at the bottom of the skin allows for device charging whenever a GDS® Dock™ is unavailable. For power and data capabilities on the go, turn to RAM® cradles including key and combination locking versions.

AVAILABLE IN:

 KEY LOCK	 COMBO LOCK	 NON-LOCKING
 POWER	 POWER + DATA	

1. RAM-H0L-SAM52PDU, RAM® EZ-Roll'r™ Power & Data Cradle
 RAM-KEY2-USB, GDS® Keyboard™ with Track Pad
 RAM-101U, RAM® Double Ball Mount with Two Round Plates
 RAM-DIS-103-1U, RAM® Short Accessory/Display Bracket
2. RAM-SKIN-SAM52, RAM® Skin™
3. RAM-H0L-SAM52PDCLU, RAM® Power + Data Combo-Locking Cradle
4. RAM-H0L-SAM52PKLU, RAM® EZ-Roll'r™ Powered Key-Locking Cradle
5. RAM-H0L-SAM52PDU, RAM® EZ-Roll'r™ Power & Data Cradle
6. RAM-DOCK-6G8PU, RAM® Powered 6 Gang Dock
7. RAM-GDS-SS1U, GDS® Shoulder Strap Accessory for IntelliSkin® Products
8. RAM-GDS-HS1U, GDS® HandStand™ Tablet Hand Strap and Kick Stand



SEE PAGE 60 FOR
SAMSUNG TAB ACTIVE PRO
COMPATIBILITY GUIDE



2

RAM® SKIN™ FEATURES

- Protective sleeve features military-grade drop protection and a built-in S Pen holder
- Compatible with GDS® HandStand™ and shoulder strap accessories
- Pair with RAM® power and data cradles for charging capabilities
- Backed by a lifetime warranty



3



4



5

LOCKING, POWER, AND DATA CRADLES FEATURES

- Choose from key and combination locking versions with power and data capabilities
- RAM® Mounts Compatible™ with AMPS hole pattern components
- Access to stylus remains while the device is docked
- 3-year warranty for electronic components
- Compatible with factory skin and RAM® Skin™



6



8

+ SEE PAGE 61 FOR
TABLET COMPATIBILITY GUIDE



1

**TABLETS & TABLET PCs
POWERED, FORM-FIT &
UNIVERSAL CRADLES**

RAM® tablet cradles have long been trusted by consumers and in business applications. Depending on your device, take advantage of several different device holders. For example, powered cradles ensure your tablet can be used throughout the day and are available in locking versions for added security. Universal options include the popular RAM® X-Grip® for tablets, and the spring-loaded RAM® Tab-Lock™ — compatible with risers to support accessories like hand straps.

- 1.** RAM-247U-25, Square Post Clamp with 1.5" Ball
RAM-201U, Standard Socket Arm for 1.5" Ball
RAM-202U, AMPS Device Adapter with 1.5" Ball
RAM-H0L-TABL20U, RAM® Tab-Lock™ Holder (shown with iPad 9.7 with LifeProof Case)
- 2.** RAM-H0L-SAM7PKLU, RAM® Key-Locking Powered Cradle for Samsung Galaxy Tab Active2
- 3.** RAM-H0L-UN9U, RAM® X-Grip® Universal Holder for 9"-10" Tablets
- 4.** RAM-H0L-TABL20U, RAM® Tab-Lock™ Holder for 9" Tablets with Heavy Duty Cases
- 5.** RAM-H0L-TAB-RISER1U, RAM® 1/2" Risers for RAM® Tab-Tite™ and RAM® Tab-Lock™ Holders

+ SEE PAGE 61 FOR
TABLET COMPATIBILITY GUIDE



2



3



4

CRADLES FEATURES

- Spring-loaded designs sport great holding power without hiding your tablet
- Secure tablets with or without cases
- RAM® Tab-Lock™ offers theft and tampering deterrence
- Compatible with RAM® round ball bases for attachment to RAM® double socket arms and mounts

RISERS FEATURES

- RAM® Tab-Lock™ risers provide additional .5" of space
- Ensure compatibility for accessories like hand straps and kick stands
- Includes hardware for easy installation
- Backed by a lifetime warranty

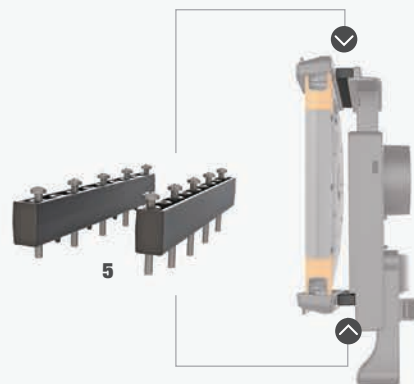

5



SEE PAGE 65 & 66 FOR
**INTELLISKIN® COMPATIBILITY
 & GDS® PRODUCT CHARTS**



1

**INTELLISKIN®
 WITH GDS® TECH™
 PROTECT YOUR INVESTMENT**

IntelliSkin® is a protective sleeve for phones and tablets featuring GDS® Tech™ with pogo pin technology and military-grade drop protection. With an integrated GDS® connector molded directly into each skin and ruggedized docking contacts on each skin's exterior, IntelliSkin® is designed to extend the life of devices by preventing damage to the charging port from repetitive docking. Next Generation IntelliSkin® sleeves feature flat docking contacts that are easier to clean, as well as a design that combines the hard plastic shell with soft, shock-absorbing rubber.

Every IntelliSkin® is compatible with a wide range of GDS® vehicle docks—safeguarding against the frequent docking and use of consumer phones and tablets in a variety of demanding field applications. When GDS® Docks™ are unavailable, most Next Generation IntelliSkin® sleeves feature a USB Type-C external power connector on each skin's exterior.

-
1. RAM-GDS-SKIN-SAM54-NG, IntelliSkin® Next Gen for Samsung Tab Active Pro
 RAM-GDS-SS1U, GDS® Shoulder Strap Accessory for IntelliSkin® Products
 2. RAM-GDS-SKIN-SAM54-NG, IntelliSkin® Next Gen for Samsung Tab Active Pro
 3. RAM-GDS-DOCKL-V9-OMT1U, GDS® Vehicle Dock for IntelliSkin® Next Gen Tablets
 4. RAM-GDS-SKIN-SAM29H, IntelliSkin® for Samsung Tab Active2 - GDS® HandStand™ Compatible
 5. RAM-GDS-SKIN-SAM39, IntelliSkin® for Samsung Galaxy S9
 6. RAM-GDS-DOCKL-V2-SAM29U, GDS® Locking Vehicle Dock for Samsung Tab Active2
 7. RAM-GDS-DOCK-V1CU, GDS® Vehicle Phone Dock with USB Type-C for IntelliSkin® Products

+ SEE PAGE 65 & 66 FOR
**INTELLISKIN® COMPATIBILITY
 & GDS® PRODUCT CHARTS**



Device

IntelliSkin®

GDS®
 Dock™

2

3



**THE DISTINCTIVE
 “DOUBLE DELTA”
 PRODUCT SHAPE**

Provides universal compatibility across Next Generation IntelliSkin® sleeves and GDS® top cups



4

5

INTELLISKIN® FEATURES

- Protective sleeve features GDS® Technology™ and military-grade drop protection
- GDS® connector and docking contacts provide charging and data sync capabilities
- Compatible with select GDS® Docks™ and accessories
- Backed by a 3-year warranty



6

7

GDS® DOCKS™ FEATURES

- GDS® Technology™ offers a universal charging platform for any device wrapped in an IntelliSkin® sleeve
- Spring-loaded docks are available for a wide range of phones and tablets
- Modular design makes upgrading to a new device simple and cost effective
- Each dock is RAM® Mounts Compatible™ with the double ball and socket system for adjustability, durability, and vibration damping



**FUTURE PROOF
SCALABLE TECHNOLOGY**

The modularity of GDS® vehicle docks provide the highest quality and most cost-effective solutions for your tablet, including future device upgrades. The GDS® Ecosystem™ and universal GDS® pogo pins provide compatibility across multiple devices.



VEHICLE DOCK CUPS

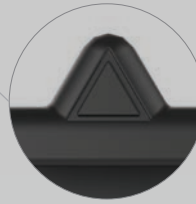

**THE DISTINCTIVE
"DOUBLE DELTA"
PRODUCT SHAPE**

Provides universal compatibility across Next Generation IntelliSkin® sleeves and GDS® top cups



**INTERCHANGEABLE
DOCK CUPS
AND TOP CUPS**



GDS® Vehicle Dock Top Cup for Samsung Tab E 8.0



GDS® Vehicle Dock Top Cup for Apple iPad mini 4



GDS® Vehicle Dock Top Cup for Apple iPad Air 2



GDS® Vehicle Dock Top Cup with Audio Cable for Samsung Tab 4 8.0

**FUTURE PROOF
INTERCHANGEABLE SOLUTIONS**

With interchangeable dock cups and top cups, you can easily modify your existing dock to work with your new IntelliSkin®-enabled device. Vehicle dock cups attach to the base of locking and non-locking GDS® Docks™ so you can ensure compatibility with a variety of IntelliSkin® sleeves.

+ SEE PAGE 66 FOR
GDS® PRODUCT CHARTS



**GDS®
DESKTOP DOCKS
MIX AND MATCH
DEVICE CHARGING**

Perfect for office environments, GDS® desktop docks can support any device equipped with an IntelliSkin® sleeve to deliver full-time charging capabilities. Each dock features GDS® pogo pins and ranges from single to multi-device support to keep phones and tablets protected and at the ready.

FEATURES

- Desktop docks enable charging for devices wrapped in IntelliSkin®
- Eliminates unnecessary cords to create a clean docking station
- Available in single and multi-device docks
- 3-year warranty for electronic components

-
- 1.** RAM-GDS-DOCK-6G1P-NGU, GDS® 6-Port Desktop Charger for Next Gen IntelliSkin®
 - 2.** RAM-GDS-SKIN-SAM54-NG, IntelliSkin® Next Gen for Samsung Tab Active Pro
 - 3.** RAM-GDS-SKIN-SAM39, IntelliSkin® for Samsung Galaxy S9
 - 4.** RAM-GDS-DOCK-D2CU, GDS® Desktop Dock with USB Type-C for IntelliSkin® Products

+ SEE PAGE 66 FOR
GDS® PRODUCT CHARTS



Compatible with any tablet size and brand with IntelliSkin®

GDS® SLIDE DOCK™
MULTI-DEVICE CHARGING SOLVED

Designed to solve charging issues in a variety of applications, the GDS® Slide Dock™ is a scalable solution for charging multiple devices at the same time. It can be integrated into any flat surface, charging carts, and more. Each GDS® Slide Dock™ includes an LED indicator light that lets you know whether or not it's connected to power, and is available as both a drill-down attachment or a magnetic base.

FEATURES

- Adjustable height to accommodate a variety of devices
- Magnetic base to quickly attach to your mounting location
- Pogo pin contacts eliminate the need to plug in cables
- LED indicator light lets you know your dock is connected to power

5. RAM-GDS-DOCK-G7U, GDS® Slide Dock™

+ SEE PAGE 66 FOR
GDS® PRODUCT CHARTS



1

GDS® ECOSYSTEM™
TURN TO DISTINCTIVE
GDS® GREEN™ FOR
ANY VERTICAL

The GDS® Ecosystem™ offers everything to keep your devices protected, connected, and charged in nearly any application. Ruggedized GDS® Technology™ pogo pins ensure compatibility across IntelliSkin® sleeves and GDS® Docks™, adapters, chargers, keyboards, speakers, monitors, and more. And most products in the GDS® Ecosystem™ are RAM® Mounts Compatible™, so you can rely on the RAM® double ball and socket system for adjustability, durability, and vibration damping.

With Samsung DeX-enabled device, you can transform your phone into a mobile office—from your vehicle to your desk. By connecting a Samsung DeX enabled device via USB to a GDS® Dock™, keep your device protected and charged while taking advantage of the desktop experience.

-
1. RAM-GDS-SKIN-SAM29H, IntelliSkin® for Samsung Tab Active2 - GDS® HandStand™ Compatible
RAM-GDS-DOCKL-V2-SAM29U, GDS® Locking Vehicle Dock for Samsung Tab Active2
RAM-KEY4-USB, GDS® Keyboard™ with 10-Key Numeric Pad and USB Cable
RAM-HOL-TAB-RISER2U, RAM® 1" Risers for RAM® Tab-Tite™ and RAM® Tab-Lock™ Holders
RAM-101U, RAM® Double Ball Mount with Two Round Plates
RAM-DIS-103-1U, RAM® Short Accessory/Display Bracket
RAM-D-247U-4, RAM® Square Post Clamp Base for Posts up to 4" Wide
RAM-D-201U-C, RAM® Double Socket Arm
RAM-D-254U, RAM® Round AMPS Plate with Ball
 2. RAM-GDS-MON-13-1, GDS® View™ 13.3" Touch Screen Monitor
 3. RAM-KEY2-USB, GDS® Keyboard™ with Track Pad
 4. RAM-GDS-HUB-TYPEC-01, GDS® Tough-Hub™ With USB Type-C For Vehicles

+ SEE PAGE 66 FOR
GDS® PRODUCT CHARTS



GDS® VIEW™ FEATURES

- Two-point capacitive touchscreen monitor
- Anti-glare and anti-fingerprint treated LCD screen
- MIL-STD-810G 514.5 vibration tested
- RAM® Mounts Compatible™ with the double ball and socket system for adjustability, durability, and vibration damping

GDS® KEYBOARD™ FEATURES

- Choose between IP65 rated 10-key numeric pad or mouse track pad versions
- Backlit keypad with red illumination to reduce eye strain
- RAM® Tab-Tite™ and RAM® Tab-Lock™ holders provide spring-loaded mounting options
- Features both VESA and AMPS hole patterns

LEARN MORE AT
GDSTECH.COM

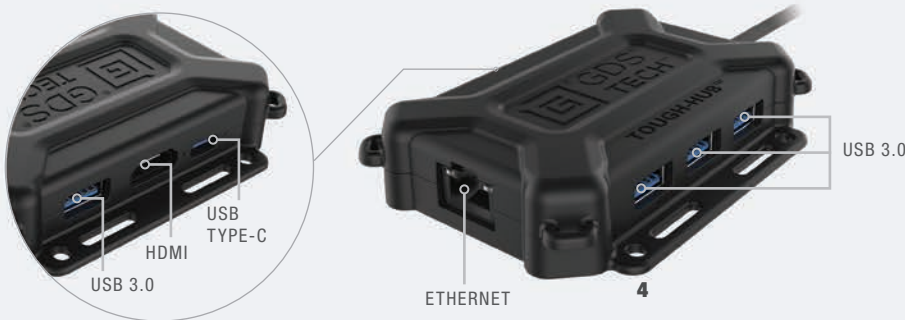

GDS® TOUGH-HUB™ FEATURES

- Easily connect accessories and peripherals to your device using a variety of inputs and outputs
- Includes both USB Type-A and USB Type-C power delivery ports
- HDMI output supports Samsung DeX and screen mirroring for compatible devices
- USB Type-C pigtail connector supports most Type-C phones and tablets



SEE PAGE 66 FOR
GDS® PRODUCT CHARTS



1

**GDS® ERGO™ & POWER
ACCESSORIES**
**ACCESSORIES THAT GET
THE JOB DONE**

Take advantage of GDS® Ergo™ accessories like the GDS® HandStand™ and shoulder strap to enable your tablet for field use. The GDS® HandStand™ is a combination hand strap and kick stand that allows you to easily take your device from the warehouse to the office—and everywhere in between. With the shoulder strap accessory, quickly attach various IntelliSkin® sleeves using the snap hooks to comfortably carry your tablet.

In addition, the IntelliSkin® contact brush can be used to clean debris build-up on the GDS® contacts of IntelliSkin® sleeves. Performing routine cleaning of the GDS® contacts helps to maintain excellent performance and prevent any loss in functionality. An included adhesive pad can be attached to a variety of surfaces.

-
1. RAM-GDS-HS1U, GDS® HandStand™ Tablet Hand Strap and Kick Stand
RAM-GDS-SS1U, GDS® Shoulder Strap Accessory for IntelliSkin® Products
RAM-SKIN-SAM52, RAM® Skin™ for Samsung Tab Active Pro
 2. RAM-GDS-SS1U, GDS® Shoulder Strap Accessory for IntelliSkin® Products
 3. RAM-GDS-HS1U, GDS® HandStand™ Tablet Hand Strap and Kick Stand
 4. RAM-GDS-STU, GDS® Wrist Strap for IntelliSkin®



SEE PAGE 66 FOR
GDS® PRODUCT CHARTS



FEATURES

- GDS® Ergo™ accessories enable devices for field use
- GDS® HandStand™ consists of a combination hand strap and kick stand
- Shoulder strap accessory quickly attaches using snap hooks to compatible IntelliSkin® sleeves
- Wrist strap accessory easily installs using the eyelet loop on a variety of IntelliSkin® sleeves

+ SEE PAGE 63 FOR
**SCANNER GUN
 COMPATIBILITY GUIDE**



1

**SCANNER GUN HOLDERS
 ERGONOMIC SOLUTIONS**

Keep scanner guns in an ergonomic and user-friendly location with these rugged holders. The open bottom design of the RAM® Power-Grip™ enables scanning while in the holder, and replaceable elastomeric fins grip the handle of the scanner for a secure hold. Another holder, the RAM® Drop-N-Lock™, is designed to hold most types of pistol grip mobile computers with scanning capabilities. The spring-loaded lever on the side of the holder secures devices – simply drop the handle into the holder and it locks in place. And last but not least, the rugged RAM® Quick-Draw™ also features spring-loaded functionality to secure scanner guns and handheld computers that fit within the compatible dimensions.

- 1. RAP-396U, RAM® Power-Grip™ Universal Scanner Gun Holder
 RAM-101U-247-4, RAM® Square Post Clamp Mount for Posts up to 4" Wide
- 2. RAP-450U, RAM® Power-Grip™ XL Universal Scanner Gun Holder
- 3. RAP-396U, RAM® Power-Grip™ Universal Scanner Gun Holder
- 4. RAP-317U, RAM® Drop-N-Lock™ Scanner Gun Holder
- 5. RAM-H0L-QD1U, RAM® Quick-Draw™ Spring Loaded Holder

+ SEE PAGE 63 FOR
**SCANNER GUN
 COMPATIBILITY GUIDE**



2



3

RAM® POWER-GRIP™ & RAM® POWER-GRIP™ XL FEATURES

- Universal scanner gun holder
- Replaceable elastomeric fins grip the handle of the scanner gun for a secure fit
- Includes both side and bottom mounting attachment points
- Compatible with GDS® shoulder strap accessory and third-party lanyards



4

RAM® DROP-N-LOCK™ FEATURES

- Universal scanner gun holder
- Spring-loaded to easily secure compatible devices
- Drop scanner gun into holder to lock into place
- To remove device, simply lift the tab on the back of the holder to remove



5

RAM® QUICK-DRAW™ FEATURES

- Accommodates scanner guns and handheld computers
- Spring-loaded side cups support devices within the compatible dimensions
- Ideal for warehouse vehicles like forklifts
- Made of high-strength composite materials

+ SEE PAGE 67 FOR
RAM® MOUNTS
PRODUCT CHARTS



PRINTER CRADLES
FORM-FIT SOLUTIONS

RAM® Mounts offers multiple mounting solutions that accommodate a wide variety of printer and scanner configurations. RAM® form-fit holders are designed specifically for the Brother PocketJet series, while spring-loaded cradles secure a range of dynamic printers and scanners.

- 1. RAM-VPR-101, RAM® Printer Cradle for Brother PocketJet 7 series, 6/6 Plus & 673
- 2. RAM-VPR-104, RAM® Quick-Draw™ Jr. Universal Small Printer Holder



UNIVERSAL HOLDERS
FOR LAPTOPS, TABLETS & PHONES

These universal holders get the job done for a variety of devices. The RAM® Tough-Tray™ II is a spring-loaded tray for tablets and small laptops. Also featuring spring-loaded arms is the RAM® Quick-Grip™ for phones. Using the RAM® Finger-Grip™, secure handheld devices with adjustable rubber-coated fingers.

- 3. RAM-HOL-UN4U, RAM® Finger-Grip™ Universal Phone and Radio Holder
- 4. RAM-234-6, RAM® Tough-Tray™ II Spring Loaded Netbook/Tablet Holder

SEE PAGE 67 FOR
RAM® MOUNTS
PRODUCT CHARTS



RAM® QUICK-GRIP™ & RAM® QUICK-GRIP™ XL FEATURES

- Easily insert and remove your phone with one hand
- Spring-loaded holder features adjustable side supports that provide a secure fit for large phones
- Ball and socket technology allows for near-infinite adjustability
- Made of powder-coated, marine-grade aluminum and high-strength composite



RAM® X-GRIP® FEATURES

- Spring-loaded 'X' design with rubber caps provides a secure fit for phones of nearly any size
- Leaves buttons and ports exposed and accessible
- Includes optional safety tether for extra security and peace of mind
- Available in standard and large versions

**PHONE
 HOLDERS
 UNIVERSAL
 SOLUTIONS**

Popular spring-loaded phone holders like the RAM® Quick-Grip™ and RAM® X-Grip® are trusted by users around the world. Compatible with RAM® double socket arms and a wide variety of RAM® mounting bases, each phone holder is designed to secure devices in the most demanding applications while keeping all functionality and quick access.

- 5.** RAM-H0L-PD4-238AU, RAM® Quick-Grip™ XL Phone Holder with Ball
- 6.** RAM-H0L-PD3U, RAM® Quick-Grip™ Phone Holder
- 7.** RAM-H0L-UN10BU, RAM® X-Grip® Large Phone Holder with Ball
- 8.** RAM-H0L-UN7BU, RAM® X-Grip® Universal Phone Holder with Ball



SEE PAGE 69 FOR ALL
OVERHEAD GUARD BASES



1

BASES



SEE PAGE 69 FOR
OVERHEAD GUARD BASES

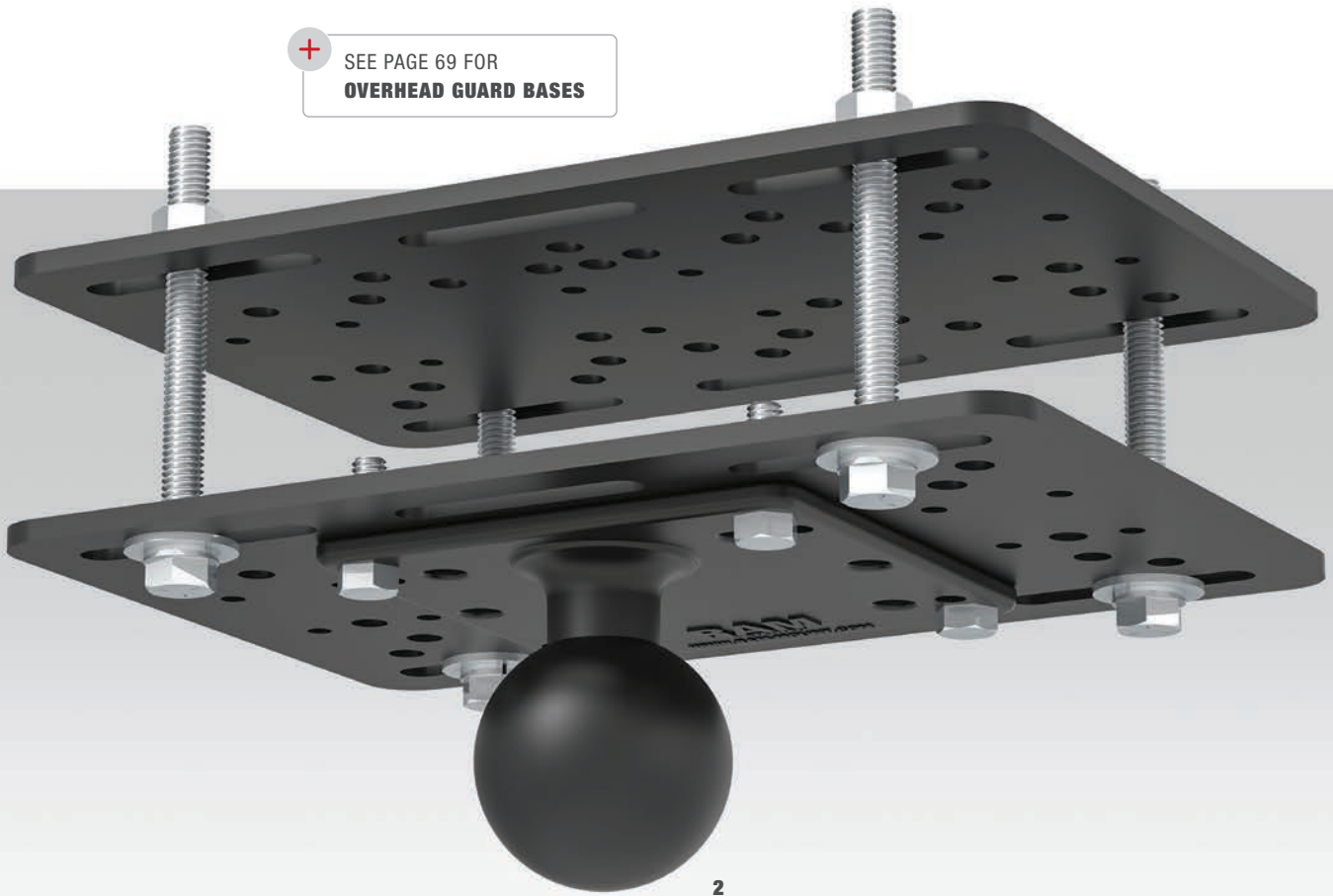

2

OVERHEAD GUARD PLATES

SECURE COMPUTERS, PRINTERS, SCANNERS & MORE

Utilize two identical stamped steel plates that fasten to most lift cages and overhead guards to mount computers, printers, scanners, and tablets. This rugged mount allows for the attachment of bases with a variety of RAM® Mounts ball sizes. The plates include both the VESA and AMPS hole patterns. Multiple ball bases can be attached to the same plate, helping to keep all your devices in one convenient location.

FEATURES

- Overhead guard plates feature both VESA and AMPS hole patterns
- Ideal for mounting computers, printers, scanners, and more
- D size RAM® rubber ball allows for connection to any D size RAM® double socket arm
- Includes two identical stamped steel plates

-
1. RAM-335-D-246, Overhead Guard Plate with 2.25" Ball
RAM-D-201U-C, Short Socket Arm for 2.25" Ball
RAM-D-254U, AMPS Device Adapter with 2.25" Ball (shown with Honeywell Thor VM3)
 2. RAM-335-D-246, Overhead Guard Plate with 2.25" Ball



SEE PAGE 69 FOR ALL
SQUARE POST CLAMP BASES



1

SQUARE POST CLAMP
EASILY ADJUSTABLE

These bases allow for the attachment of a RAM® rubber ball to a variety of square post sizes. Once attached, complete your mounting setup by taking advantage of the RAM® double ball and socket system. Paired with a double socket arm and device holder, the bases secure mobile PCs, scanners, printers, tablets, phones, and more.

-
- 1.** RAM-247U-25, Square Post Clamp with 1.5" Ball
RAM-201U, Standard Socket Arm for 1.5" Ball
RAM-202U, AMPS Device Adapter with 1.5" Ball
RAM-GDS-DOCKL-V2-SAM23U, Locking GDS® Vehicle Dock for the Samsung Tab A 10.1 with S Pen
RAM-GDS-SKIN-SAM26, IntelliSkin® for the Samsung Tab A 10.1 with S Pen (shown with tablet)
 - 2.** RAM-247U-3, RAM® Square Post Clamp Base for Posts up to 3" Wide
 - 3.** RAM-247U-25NH, RAM® Square Post Clamp Base for Posts up to 2.5" Wide Without Hardware
 - 4.** RAM-247U-4, RAM® Square Post Clamp Base for Posts up to 4" Wide
 - 5.** RAM-D-247U-25, RAM® Square Post Clamp Base for Posts up to 2.5" Wide
 - 6.** RAM-D-247U-4, RAM® Square Post Clamp Base for Posts up to 4" Wide

+ SEE PAGE 69 FOR ALL
SQUARE POST CLAMP BASES

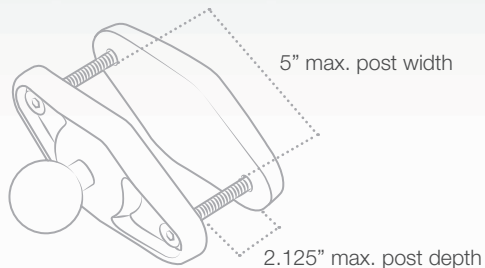

FEATURES

- Clamping base ideal for a range of square post sizes
- Post clamps are adjustable and easily removable
- Attached RAM® rubber ball allows for connection to RAM® double socket arms and device holders
- Made of powder-coated, marine-grade aluminum



SEE PAGE 69 FOR ALL
RAIL CLAMP AND POST BASES



**ROUND POST CLAMP
INVENTIVE MOUNTING SOLUTION**

Secure your mount to any round post and ensure that your tablet, inventory management device, or scanner is at the ready. Available in two sizes, this mounting solution fits most round overhead guard legs and holds a variety of device weights.

FEATURES

- Clamping base ideal for a range of round post sizes
- Post clamps are adjustable and easily removable
- Attached RAM® rubber ball allows for connection to RAM® double socket arms and device holders
- Made of powder-coated, marine-grade aluminum

-
- 1.** RAM-D-271U-2, Round Post Clamp with 2.25" Ball
RAM-D-201U, Standard Double Socket Arm for 2.25" Ball
RAM-D-202U, Device Adapter with 2.25" Ball (shown with Honeywell Thor CV31)
RAM-202U-IN10, Keyboard Adapter Plate
RAM-202U, AMPS Device Adapter with 1.5" Ball
RAM-201U-B, Short Double Socket Arm for 1.5" Ball
 - 2.** RAM-271U-12, RAM® Rail Clamp Ball Base for 1.25" - 1.875" Rails
 - 3.** RAM-D-271U-2, RAM® Rail Clamp Ball Base for 2" - 2.5" Rails



SEE PAGE 69 FOR ALL
RAIL CLAMP AND POST BASES



6



4



5



CROWN WORK ASSIST®

RAM® BALL BASE

Easily attach this RAM® ball base to the Crown Work Assist® to enable the RAM® double ball and socket system. With a RAM® double socket arm and device holder connected, ensure vibration damping and the perfect placement of devices.

- 4. RAM-D-202U-CR01, RAM® Ball Base for Crown Work Assist®
- 5. RAM-202U-CR01, RAM® Ball Base for Crown Work Assist®
- 6. RAM-202U-CR01, RAM® Ball Base for Crown Work Assist®
RAM-201U, Standard Double Socket Arm
RAM-2461U, RAM® 75x75mm VESA Plate with Ball

U-BOLT

IDEAL FOR POSTS WITH LOW CLEARANCE

The U-bolt mount offers a secure, low-profile mounting solution that is a perfect fit in tight spaces such as on posts with low clearance. With the option of three ball diameters and double U-bolt configurations for rough environments, there is a U-bolt for every use case.



7



8

- 7. RAM-231-1U, RAM® Handlebar U-Bolt Base
for Rails 1"-1.25" in Diameter
- 8. RAM-D-235U, RAM® Double U-Bolt Ball Base
for Rails 1"-1.25" in Diameter



SEE PAGE 69 FOR ALL
DRILL-DOWN BASES



1

**DRILL-DOWN
FOR FLAT SURFACES**

RAM® Mounts offers versatile bases in several sizes and shapes that can be drilled-down to a variety of any flat surface. Each base includes mounting holes, such as the AMPS and VESA hole patterns, for a variety of mounting options.

FEATURES

- AMPS and VESA hole patterns for connection to a variety of devices
- Choose the compatible RAM® rubber ball for attaching double socket arms and device holders
- Available in a wide range of shapes and sizes, including round, rectangle, and square plates
- Made of powder-coated, marine-grade aluminum

-
- 1.** RAM-111BU, RAM® Universal Marine Electronic Ball
RAM-201U, RAM® Double Socket Arm
RAM-202U, RAM® Round Plate with Ball
RAM-GDS-DOCKL-V2-SAM40U, GDS® Vehicle Dock for the Samsung Tab A 8.0 (2018) SM-T387
RAM-GDS-SKIN-SAM40, IntelliSkin® for Samsung Galaxy Tab A 8.0 (2018) SM-T387
RAM-KNOB5LU, RAM® Key Lock Knob with Brass Insert for C Size Socket Arms
 - 2.** RAM-202U, RAM® Round Plate with Ball
 - 3.** RAM-D-202U, RAM® Large Round Plate with Ball
 - 4.** RAM-E-246U-IN1, RAM® Steel Reinforced 100x100mm VESA Plate with Ball

+ SEE PAGE 69 FOR ALL
DRILL-DOWN BASES



2



3



4

+ SEE PAGE 69 FOR ALL
RAM® TOUGH-MAG™



1

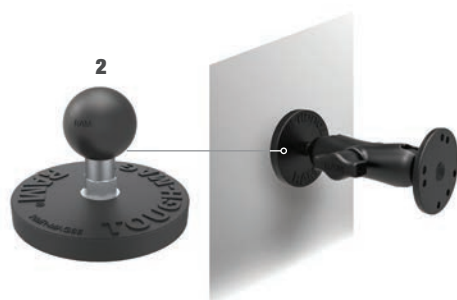

2
6 MAGNETS
Max. weight 11lb
66mm diameter base

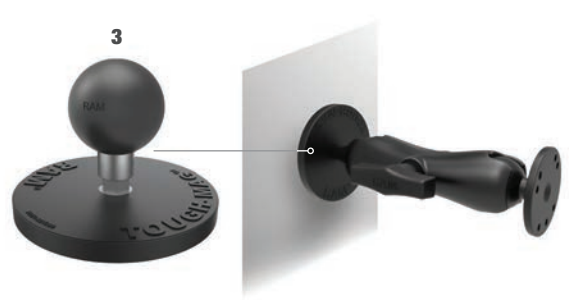

3
12 MAGNETS
Max. weight 3lbs
88mm diameter base

**RAM® TOUGH-MAG™
MAGNETIC BASES**

Ideal for mounting to a metal surface, the RAM® Tough-Mag™ is available in two different sizes with a RAM® ball screwed into a 1/4-20" threaded post. Each base features industrial-strength N35 grade magnets and rubber coating to protect the mounting surface.

Please note: weight limits are for static environments only.

- 1.** RAM-B-MAG66U, RAM® Tough-Mag™ 66MM Diameter Ball Base
RAM-B-201U, RAM® Double Socket Arm
RAM-B-238U, RAM® Diamond Ball Base
RAM-HOL-SAM9PU, RAM® EZ-Roll™ Powered Cradle for Samsung XCover Pro
- 2.** RAM-B-MAG66U, RAM® Tough-Mag™ 66MM Diameter Ball Base
- 3.** RAM-MAG88U, RAM® Tough-Mag™ 88MM Diameter Ball Base

+ SEE PAGE 69 FOR ALL
**RAIL CLAMP AND
POST BASES**



4

**STRAP HOSE CLAMP
WITH METAL STRAP**

The strap hose clamp features a metal strap that provides a firm hold on round posts. Wrap the strap around the post and base, then tighten the worm-drive clamp with a screwdriver until secure. The rubber strip included with the base protects the post from damage.

FEATURES

- Saddle-shaped clamp is compatible with rails from 1" to 2.1" in diameter
- Available in B and C size options for connection to RAM® double socket arms and device holders
- Made of powder-coated, marine-grade aluminum
- Backed by a lifetime warranty

4. RAM-B-108BU, RAM® Strap Hose Clamp Ball Base



5



6



7

**RAM®
TOUGH-CLAW™
CLAMPING BASES**

The RAM® Tough-Claw™ is the perfect mounting base for easy installation and removal without tools on round, square, and odd-shaped posts and bars. The RAM® Tough-Claw™ can be clamped to posts from .625" to 2.25" in diameter. Ideal for mounting tablets, scanners, radios and more, the RAM® Tough-Claw™ is a trusted and versatile mounting solution.

FEATURES

- Quickly clamp to round, square, and odd-shaped rails and bars
- Available in small, standard, and large sizes with rubber pads that provide stable gripping and protection of the mounting surface
- B and C size options available for connection to RAM® double socket arms and device holders
- Made of stainless steel hardware and high-strength composite

5. RAP-401U, RAM® Tough-Claw™ Large Clamp Ball Base

6. RAP-404U, RAM® Tough-Claw™ Medium Clamp Ball Base

7. RAP-400U, RAM® Tough-Claw™ Small Clamp Ball Base



1

SWING ARM POST CLAMPS

- 1. RAM-247U-4P1, Swing Arm Post Clamp Base
- RAM-261-2U, Swing Arm Extension with Double Ball Adapter
- RAM-201U-B, Short Socket Arm with 1.5" Ball
- RAM-202U, AMPS Device Adapter with 1.5" Ball
- RAM-GDS-DOCKL-V2-SAM23U, Locking GDS® Vehicle Dock for the Samsung Tab A 10.1 with S Pen
- RAM-GDS-SKIN-SAM26, IntelliSkin® for the Samsung Tab A 10.1 with S Pen (shown with tablet)
- RAM-201U, Standard Socket Arm with 1.5" Ball
- RAM-202U, AMPS Keyboard Adapter with 1.5" Ball

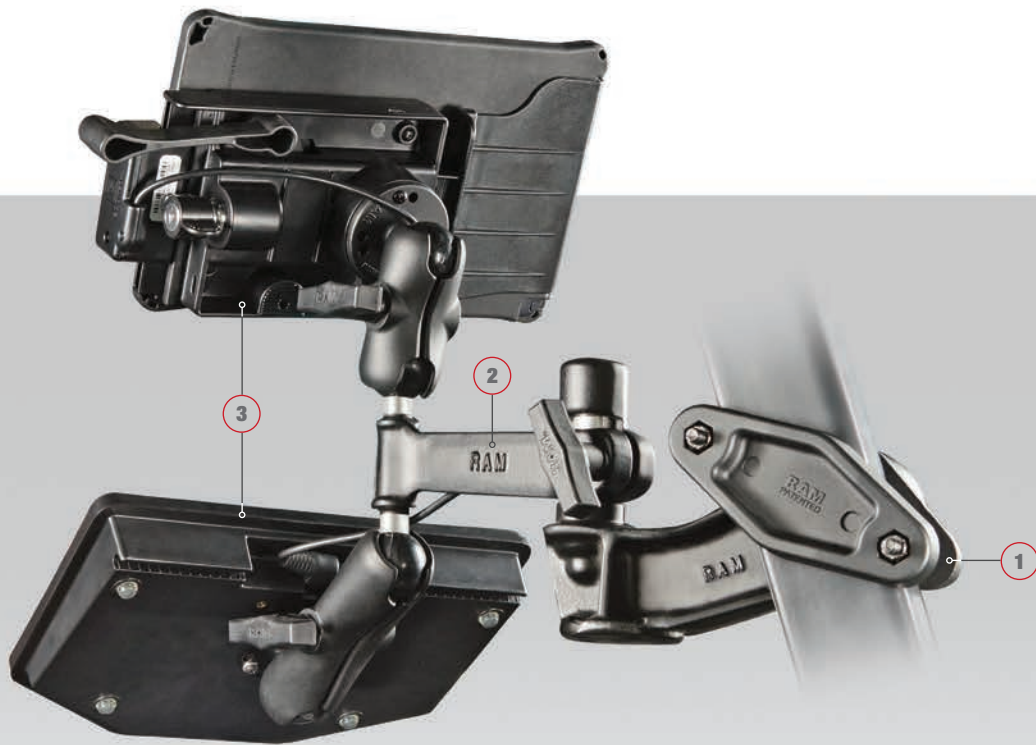

1 CHOOSE A BASE

Select from a variety of bases to help secure your device where you need it.



2 CHOOSE A SWING ARM OR EXTENSION

Twist and tilt the placement and viewing angle of any connected device with a range of swing arms, extensions, and ball adapters.



3 DEVICE HOLDERS AND ACCESSORIES

Compatible ball plates and double socket arms ensure you can secure phones, tablets, scanners, printers, keyboards, mobile PCs, and much more to complete your setup.





- 1. RAM-247U-4P1, Max Post Width: 4", Max Post Depth: 1.75"
- 2. RAM-D-247U-4P1, Max Post Width: 4"
- 3. RAM-261-1U, For 1.5" (C) Ball Components
- 4. RAM-D-261-1U, For 2.25" (D) Ball Components
- 5. RAM-261-ADJU, Adjustable Arm for 1.5" (C) Ball Components
- 6. RAM-261-2U, For 1.5" (C) Socket Arms
- 7. RAM-261U, For 1.5" (C) Ball Components
- 8. RAM-D-261U, For 2.25" (D) Ball Components



**BASE
FOR 1.5" (C) BALL & SOCKET MOUNTS**



**BASE
FOR 2.25" (D) BALL & SOCKET MOUNTS**



**SWING ARM EXTENSION
FOR 1.5" (C) BALL & SOCKET MOUNTS**



**SWING ARM EXTENSION
FOR 2.25" (D) BALL & SOCKET MOUNTS**



**SWING ARM WITH BALL/ SOCKET ADAPTER
FOR 1.5" (C) BALL & SOCKET MOUNTS**



**SWING ARM WITH BALL/ SOCKET ADAPTER
FOR 2.25" (D) BALL & SOCKET MOUNTS**



1

ACCESSORIES

+ SEE PAGE 69 FOR ALL
LOCKING KNOBS

RAM® HI-TORQ™ WRENCH

EXTRA LEVERAGE FOR DEMANDING ENVIRONMENTS

The RAM® Hi-Torq™ wrench is used with the knob on D size (2.25") arms. This wrench provides the extra leverage needed to tighten the mount in cold weather or in small spaces.

1. RAM-D-202U-CR01, Crown Work Assist Adapter with 2.25" Ball
RAM-D-201U-C, Short Socket Arm with 2.25" Ball
RAM-D-202U-23, Device Adapter with 2.25" Ball (shown with Zebra VC80)
RAM-KN0B9HU, RAM® Hi-Torq™ Wrench for 2.25" Ball
2. RAM-KN0B9HU, RAM® Hi-Torq™ Wrench for D Size Socket Arms



RAM® PIN-LOCK™ SECURITY KNOB AND KEY

PREVENT THEFT AND TAMPERING

Using a female threaded security knob and key knob, the mixed combination RAM® Pin-Lock™ security knob and key can replace all knobs on B size (1") and C size (1.5") arms and mounts to prevent theft and tampering.

3. RAP-S-KN0B3U, RAM® Pin-Lock™ Security Knob for B Size Socket Arms



KEYED LOCKING KNOB

KEEP ELECTRONICS LOCKED IN PLACE

The keyed locking knob adds tampering and theft deterrence to your B size (1") and C size (1.5") ball mounts by replacing the standard knob. This an ideal accessory to keep your mounted electronic devices safe and locked into position.

4. RAM-KN0B5LU, RAM® Key Lock Knob with Brass Insert for C Size Socket Arms





RAM® SHOCK BUSTER™
ADDED SHOCK AND VIBRATION DAMPING

This VESA hole pattern adapter absorbs shock and vibration for mounting systems in the most extreme environments. Featuring an integrated 40A durometer shock isolator, the RAM® Shock Buster™ fits between any 75mm VESA RAM® Mounts component and the device you're mounting.

FEATURES

- Integrated elastomeric shock isolator
- Absorbs shock and vibration in demanding environments
- Added protection is ideal for a variety of electronic devices
- Features 75mm VESA hole pattern for easy connection to compatible RAM® components

-
1. RAM-335-D-246, Overhead Guard Plate with 2.25" Ball
RAM-D-201U-C, Short Socket Arm for 2.25" Ball
RAM-D-2461U, VESA Device Adapter with 2.25" Ball (shown with JLT VERSO)
RAM-SHOCK-75U, RAM® Shock Buster™ Adapter
 2. RAM-SHOCK-75U, RAM® Shock Buster™ Adapter with 75mm VESA Hole Pattern





1



2



RAM® HANDI-CASE™
VERSATILITY FOR ANY
WORK ENVIRONMENT

The RAM® Handi-Case™ keeps all of your paperwork, packing slips, and other items organized anywhere you need it. Beyond being a writing surface, you get document storage, a tool holder, pen and pencil storage, and the durability to withstand any working environment. A variety of knockout hole patterns make it easy to mount, or secure the RAM® Handi-Case™ flush on any metal surface with additional magnets.

FEATURES

- Multiple mounting points on top and bottom to attach any number of popular RAM® ball bases or mounting plates for unsurpassed versatility
- Attachment points allow for mounting of phones, GPS units, or other small electronics
- Multiple punch outs on the sides and back make it possible to run power into or out of the case
- Multiple storage spaces inside the case can hold documents, pens, nuts, bolts, and more

1. RAM-HC1U, RAM® Handi-Case™

2. RAM-HC1U, RAM® Handi-Case™
RAM-HC1-MAGU, Additional Mounting Magnets



3



4



**RAM® MULTI-PAD™
DURABLE NOTEPAD HOLDER**

Keep important documents securely in place and organized with this durable pad holder. Utilize the integrated magnets to hold the included metal pen in place. Compatible with any 3"-4" three ring binder notepad, the RAM® Multi-Pad™ utilizes multiple mounting points so it can be easily attached to any RAM® Mounts with the universal AMPS hole pattern.

FEATURES

- Features two rare earth magnets, metal pen, and detachable clip
- Easily secure 3" to 4" notepads
- Hardware included for attaching to components with AMPS hole pattern
- RAM® Mounts Compatible™ with a variety of mounting bases

-
- 3. RAM-247U-4, Square Post Clamp with 1.5" Ball
RAM-201U, Standard Arm for 1.5" Ball
RAM-202U, AMPS Device Adapter with 1.5" Ball
RAM-HOL-MP1U, RAM® Multi-Pad™ Organizer
 - 4. RAM-HOL-MP1U, RAM® Multi-Pad™ Organizer



1



2

THINK OUTSIDE THE WAREHOUSE

INVENTIVE MOUNTING SOLUTIONS FOR THE LONG HAUL

After product leaves the warehouse, RAM® Mounts is there for the long haul. From laptop and wireless phone chargers to locking vehicle mounts to ELD mandate bundle solutions, RAM® has long been a trusted partner in the transportation and logistics industry. These in-cab systems provide delivery trucks and large fleets with the tools they need to get the job done everyday. Our durable mounting solutions are the most versatile of their kind, allowing customers to scale without spending money on entire new systems.

You can always feel confident knowing that RAM® mounting components are backed by a lifetime warranty, while electronic products are covered by a one to three year warranty. We believe in the product so much that we're confident it can support nearly any mounting need you have. If you have a custom mounting need, get in touch with our mounting experts at sales@rammount.com.



**WATER
PROOF**



For added security and peace of mind, a safety tether is included with each holder for outdoor applications

1



For added security and peace of mind, a safety tether is included with each holder for outdoor applications

2

RAM® TOUGH-CHARGE™ WITH X-GRIP® TECHNOLOGY FIRST OF ITS KIND PHONE HOLDER

The RAM® Tough-Charge™ with X-Grip® Technology is the world's first patented, universal waterproof wireless charging cradle for phones. Designed with spring-loaded RAM® X-Grip® Technology, this cradle features an 'X' design that expands and contracts to secure nearly any phone while taking advantage of wireless charging via the Qi standard. On the bottom of the cradle, a support leg can be adjusted to the ideal position or removed altogether. Available in a variety of mounting kits, ensure wireless charging capabilities across a wide range of vehicles.

FEATURES

- Popular spring-loaded RAM® X-Grip® technology to secure nearly any phone
- Waterproof 10W Qi wireless charging on the go
- Complete mounting kits for a wide range of vehicles and use cases, with multiple charging options
- Support leg can be easily adjusted or removed

1. RAM-B-166-UN12W, RAM® Tough-Charge™ Waterproof Wireless Charging Suction Cup Mount

RAM® QUICK-GRIP™ WIRELESS ONE-HANDED DOCKING AND REMOVAL

As part of the spring-loaded RAM® Quick-Grip™ family, this patented, universal waterproof Qi wireless charging cradle allows for single-handed placement and removal of your phone. Both the top and bottom cups feature rubber to help hold your device firmly in place, charging phones that are within the compatible dimensions. In addition, the RAM® Quick-Grip™ Wireless comes in a variety of mounting kits so you can mount it nearly anywhere you need it.

FEATURES

- Part of the spring-loaded RAM® Quick-Grip™ family
- Waterproof 10W Qi wireless charging on the go
- Complete mounting kits for a wide range of vehicles and use cases, with multiple charging options
- Allows for single-handed docking and removal of phone

2. RAM-B-166-UN14W, RAM® Quick-Grip™ Waterproof Wireless Charging Suction Cup Mount



1



2



1. RAM-VB-195-SW1, RAM® No-Drill™ Laptop Mount (shown with Panasonic Toughbook)
2. RAM-B-166-UN7U, RAM® Twist-Lock™ Suction Cup Mount with RAM® X-Grip® (shown with iPhone 11 Pro)
3. RAM-GDS-SKIN-SAM40, IntelliSkin® for Samsung Galaxy Tab A 8.0 (2018)
 RAM-GDS-DOCKL-V2-SAM40U, GDS® Vehicle Dock for the Samsung Tab A 8.0 (2018)
 RAM-B-101U, RAM® Universal Double Ball Mount with Two Round Plates
 RAM-202-225BU, RAM® Backing Plate Adapter
 RAM-GDS-CHARGE-V7BU, GDS® Modular Hardwire Charger with Female USB Type A Connector

SAMSUNG TAB ACTIVE2 COMPATIBILITY GUIDE

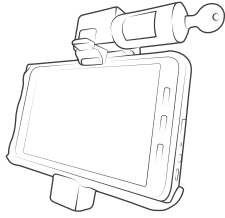

FORM-FIT HOLDERS

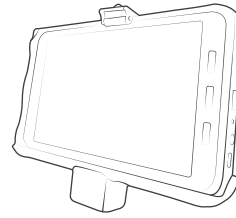

PART NUMBER	POWER TYPE	LOCK TYPE	INCLUDED CHARGER
RAM-HOL-SAM7PAU	Powered	Non-Locking	-
RAM-HOL-SAM7PCLU	Powered	Combo Locking	-
RAM-HOL-SAM7PKLU	Powered	Key Locking	-
RAM-HOL-SAM7PA-HARU	Powered	Non-Locking	Hardwire Charger
RAM-HOL-SAM7PCL-HARU	Powered	Combo Locking	Hardwire Charger
RAM-HOL-SAM7PKL-HARU	Powered	Key Locking	Hardwire Charger
RAM-HOL-SAM7P2-CIGU	Power + Data	Non-Locking	Cigarette Charger
RAM-HOL-SAM7P2-HARU	Power + Data	Non-Locking	Hardwire Charger
RAM-HOL-SAM7PCL2-CIGU	Power + Data	Combo Locking	Cigarette Charger
RAM-HOL-SAM7PCL2-HARU	Power + Data	Combo Locking	Hardwire Charger
RAM-HOL-SAM7PKL2-CIGU	Power + Data	Key Locking	Cigarette Charger
RAM-HOL-SAM7PKL2-HARU	Power + Data	Key Locking	Hardwire Charger

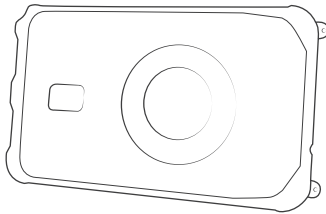

RAM® SKIN™ SOLUTIONS

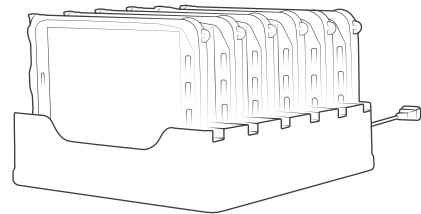

PART NUMBER	DESCRIPTION	NOTES
RAM-SKIN-SAM29	RAM® Skin™	
RAM-DOCK-6G8PU	Powered 6-Gang Dock for RAM® Skin™ and Factory Skin	
RAM-DOCK-6G8P-OT1U	Powered 6-Gang Dock for OtterBox uniVERSE	
RAM-HOL-SAM58PKLU	Key Locking Powered Holder	Compatible with GDS® HandStand™
RAM-HOL-SAM58PCLU	Combo Locking Powered Holder	Compatible with GDS® HandStand™
RAM-HOL-SAM58PDKLU	Key Locking Power + Data Holder	Compatible with GDS® HandStand™
RAM-HOL-SAM58PDCLU	Combo Locking Power + Data Holder	Compatible with GDS® HandStand™
RAM-GDS-HS1U	GDS® HandStand™	
RAM-GDS-SS1U	GDS® Shoulder Strap	
RAM-GDS-STU	GDS® Wrist Strap	

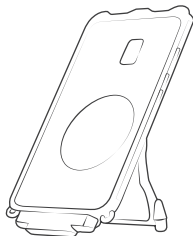

INTELLISKIN® WITH GDS® TECH™ SOLUTIONS



PART NUMBER	DESCRIPTION
RAM-GDS-SKIN-SAM29	IntelliSkin®
RAM-GDS-SKIN-SAM29H	IntelliSkin® - Compatible with GDS® HandStand™ and Shoulder Strap
RAM-GDS-DOCKL-V2-SAM29U	GDS® Vehicle Dock
RAM-GDS-DOCK-D2CU	GDS® Desktop Dock
RAM-GDS-DOCK-6G1PU	GDS® 6-Port Desktop Dock
RAM-GDS-DOCK-4G1PU	GDS® 4-Port Desktop Dock
RAM-GDS-HS1-RISER2U	GDS® HandStand™ with Vehicle Dock Risers
RAM-GDS-SS1U	GDS® Shoulder Strap
RAM-GDS-STU	GDS® Wrist Strap

SAMSUNG TAB ACTIVE PRO COMPATIBILITY GUIDE

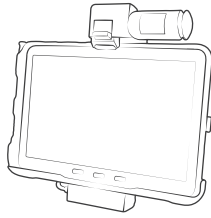

FORM-FIT HOLDERS

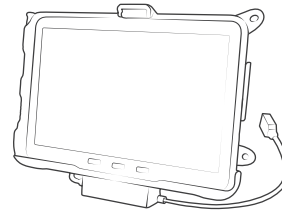

PART NUMBER	POWER TYPE	LOCK TYPE
RAM-HOL-SAM52PU	Powered	Non-Locking
RAM-HOL-SAM52PCLU	Powered	Combo Locking
RAM-HOL-SAM52PKLU	Powered	Key Locking
RAM-HOL-SAM52PDU	Power + Data	Non-Locking
RAM-HOL-SAM52PDCLU	Power + Data	Combo Locking
RAM-HOL-SAM52PDKLU	Power + Data	Key Locking

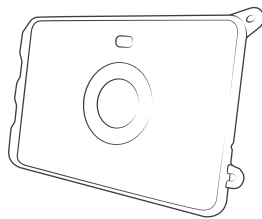

RAM® SKIN™ SOLUTIONS

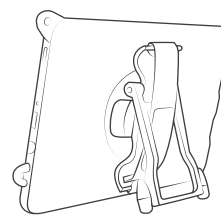

PART NUMBER	DESCRIPTION	NOTES
RAM-SKIN-SAM52	RAM® Skin™	
RAM-DOCK-6G8PU	Powered 6-Gang Dock for RAM® Skin™ and Factory Skin	
RAM-DOCK-6G8P-OT1U	Powered 6-Gang Dock for OtterBox uniVERSE	
RAM-HOL-SAM57PKLU	Key Locking Powered Holder	Compatible with GDS® HandStand™
RAM-HOL-SAM57PCLU	Combo Locking Powered Holder	Compatible with GDS® HandStand™
RAM-HOL-SAM57PDKLU	Key Locking Power + Data Holder	Compatible with GDS® HandStand™
RAM-HOL-SAM57PDCLU	Combo Locking Power + Data Holder	Compatible with GDS® HandStand™
RAM-GDS-HS1U	GDS® HandStand™	
RAM-GDS-SS1U	GDS® Shoulder Strap	
RAM-GDS-STU	GDS® Wrist Strap	

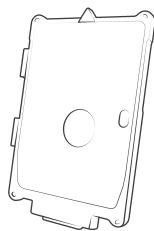

INTELLISKIN® WITH GDS® TECH™ SOLUTIONS

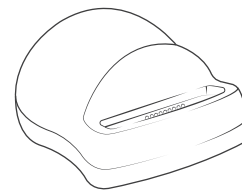

PART NUMBER	DESCRIPTION
RAM-GDS-SKIN-SAM54-NG	Next Gen IntelliSkin®
RAM-GDS-DOCKL-V9-OMT1U	GDS® Vehicle Dock
RAM-GDS-DOCK-D2C-NDU	GDS® Desktop Dock
RAM-GDS-DOCK-6G1P-NGU	GDS® 6-Port Desktop Dock
RAM-GDS-HS1-RISER2U	GDS® HandStand™ with Vehicle Dock Risers
RAM-GDS-SS1U	GDS® Shoulder Strap
RAM-GDS-STU	GDS® Wrist Strap

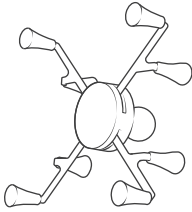
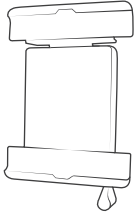
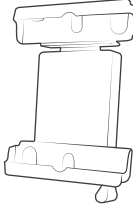
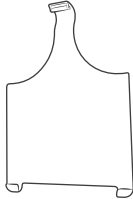

TABLET COMPATIBILITY GUIDE

MAKE	MODEL	 RAM® X-GRIP®	 RAM® TAB-LOCK™	 RAM® TAB-LOCK™ (FOR TABLETS WITH CASE)	 FORM-FIT HOLDER
Apple	iPad (5th Gen)	RAM-HOL-UN9U	RAM-HOL-TABL28U	RAM-HOL-TABL20U	RAM-HOL-AP17U
	iPad (6th Gen)	RAM-HOL-UN9U	RAM-HOL-TABL28U	RAM-HOL-TABL20U	RAM-HOL-AP17U
	iPad (7th Gen)	RAM-HOL-UN9U	RAM-HOL-TABL26U	RAM-HOL-TABL20U	RAM-HOL-AP31U
	iPad Air 3	RAM-HOL-UN9U	RAM-HOL-TABL26U	RAM-HOL-TABL20U	RAM-HOL-AP22U
	iPad mini 5	RAM-HOL-UN8BCU	RAM-HOL-TABL30U	RAM-HOL-TABL29U	RAM-HOL-AP20U
	iPad Pro 10.5 (2nd Gen)	RAM-HOL-UN9U	RAM-HOL-TABL26U	RAM-HOL-TABL20U	RAM-HOL-AP22U
	iPad Pro 11"	RAM-HOL-UN9U	RAM-HOL-TABL3U	RAM-HOL-TABL17U	RAM-HOL-AP23U
	iPad Pro 12.9 (2nd Gen)	RAM-HOL-UN11U	-	-	RAM-HOL-AP21U
	iPad Pro 12.9 (3rd Gen)	RAM-HOL-UN11U	-	-	RAM-HOL-AP24U
ASUS	iPad Pro 9.7	RAM-HOL-UN9U	RAM-HOL-TABL6U	RAM-HOL-TABL20U	RAM-HOL-AP17U
	ZenPad 10	RAM-HOL-UN9U	RAM-HOL-TABL26U	RAM-HOL-TABL20U	-
	ZenPad 3S 10	RAM-HOL-UN9U	RAM-HOL-TABL28U	RAM-HOL-TABL20U	-
	ZenPad Z10	RAM-HOL-UN9U	RAM-HOL-TABL28U	RAM-HOL-TABL20U	-
	ZenPad Z8	RAM-HOL-UN8BCU	-	-	-
Dell	ZenPad Z8s	RAM-HOL-UN8BU	RAM-HOL-TABL30U	-	-
	Latitude 5285	RAM-HOL-UN11U	RAM-HOL-TABL10U	-	-
HP	Venue 8 Pro 5855	RAM-HOL-UN8BCU	RAM-HOL-TABL27U	-	-
	Elite X2 1012 G1	RAM-HOL-UN11U	-	-	-
Lenovo	Elite X2 1012 G2	RAM-HOL-UN11U	-	-	-
	Tab 4 8	RAM-HOL-UN8BCU	RAM-HOL-TABL24U	RAM-HOL-TABL12U	
	Tab3 10 Business	RAM-HOL-UN9U	RAM-HOL-TABL6U	RAM-HOL-TABL20U	-
LG	Yoga Book	RAM-HOL-UN9U	RAM-HOL-TABL6U	-	-
	G Pad X 8.0	RAM-HOL-UN8BCU	RAM-HOL-TABL24U	RAM-HOL-TABL4U	-
Microsoft	Surface Book 2	-	-	-	-
	Surface Pro	RAM-HOL-UN9U	RAM-HOL-TABL25U	-	-
	Surface Pro (2017)	RAM-HOL-UN11U	-	-	-
Samsung	Galaxy Book 10.6	RAM-HOL-UN9U	-	-	-
	Galaxy Book 12"	RAM-HOL-UN11U	-	-	-
	Galaxy Tab A 10.1	-	-	-	-
	Galaxy Tab A 10.1 (2019)	-	RAM-HOL-TABL29U	RAM-HOL-TABL25U	-
	Galaxy Tab A 10.5	RAM-HOL-UN9U	-	RAM-HOL-TABL20U	-
	Galaxy Tab A 10.5	RAM-HOL-UN9U	RAM-HOL-TABL28U	RAM-HOL-TABL20U	-
	Galaxy Tab A 8.0 (2017)	RAM-HOL-UN8BCU	RAM-HOL-TABL24U	RAM-HOL-TABL12U	-
	Galaxy Tab A 8.0 (2018)	RAM-HOL-UN8BCU	RAM-HOL-TABL24U	RAM-HOL-TABL12U	-
	Galaxy Tab A 8.0 (2019)	RAM-HOL-UN8BCU	RAM-HOL-TABL24U	RAM-HOL-TABL12U	-
	Galaxy Tab Active2	RAM-HOL-UN8BCU	-	RAM-HOL-TABL23U	See Page 59 for Device Compatibility
	Galaxy Tab Active Pro	RAM-HOL-UN9U	RAM-HOL-TABL6U	RAM-HOL-TABL20U	See Page 60 for Device Compatibility
	Galaxy Tab E 7.0	RAM-HOL-UN8BCU	RAM-HOL-TABL18U	RAM-HOL-TABL4U	
	Galaxy Tab E 8.0	RAM-HOL-UN8BCU	RAM-HOL-TABL24U	RAM-HOL-TABL12U	
	Galaxy Tab S3 9.7	RAM-HOL-UN9U	RAM-HOL-TABL28U	RAM-HOL-TABL20U	
	Galaxy Tab S4 10.5"	RAM-HOL-UN9U	RAM-HOL-TABL28U	RAM-HOL-TABL20U	
	Galaxy Tab S5e	RAM-HOL-UN9U	RAM-HOL-TABL28U	RAM-HOL-TABL20U	
Galaxy Tab S6	RAM-HOL-UN9U	RAM-HOL-TABL28U	RAM-HOL-TABL20U		
Galaxy TabPro S	RAM-HOL-UN11U	-	-		

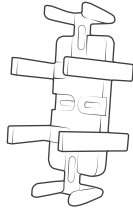
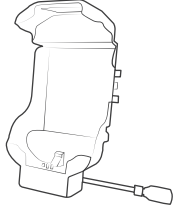
HANDHELD PC COMPATIBILITY GUIDE

MAKE	MODEL	UNIVERSAL HOLDER	FORM-FIT HOLDER
			
		UNIVERSAL HOLDER	FORM-FIT HOLDER
Datalogic	Memor 1	RAM-HOL-UN4U	-
	Memor 10	RAM-HOL-UN4U	-
	Skorpio X4	RAM-HOL-UN4U	-
Dolphin	CN80	RAM-HOL-UN4U	-
Handheld Group	Nautiz X2	RAM-HOL-UN4U	-
	Nautiz X6	RAM-HOL-UN4U	-
Honeywell	CN75	RAM-HOL-UN4U	-
	CN75e	RAM-HOL-UN4U	-
	CT50	-	RAM-HOL-HON7U - Non-Locking RAM-HOL-HON7CLU - Combo Lock RAM-HOL-HON7KLU - Key Lock
	CT60	-	RAM-HOL-HON7U - Non-Locking RAM-HOL-HON7CLU - Combo Lock RAM-HOL-HON7KLU - Key Lock
	Dolphin 6000	RAM-HOL-UN4U	-
	Dolphin 70e	RAM-HOL-UN7BU	-
	Dolphin 7800	RAM-HOL-UN4U	-
	Dolphin 9700	RAM-HOL-UN4U	-
	Dolphin CT50	RAM-HOL-UN10BU	-
	Intermec CK3	-	RAM-HOL-SUR1U
	Intermec CK3R	-	RAM-HOL-SUR1U
	Intermec CN3	-	RAM-HOL-IN11PU
	Intermec CN4	-	RAM-HOL-IN11PU
	Intermec CN50	-	RAM-HOL-IN19PBU
	Intermec CN51	-	RAM-HOL-IN19PBU
Janam	XT2	RAM-HOL-UN4U	-
Opticon	H-28	RAM-HOL-UN4U	-
	H-29	RAM-HOL-UN4U	-
Panasonic	Toughbook FZ-F1	-	RAM-HOL-PAN10U
	Toughbook FZ-N1	-	RAM-HOL-PAN10U
	Toughbook FZ-T1	-	RAM-HOL-PAN14U
Samsung	Xcover Pro	RAM-HOL-UN10BU - RAM® X-Grip® RAM-HOL-PD4-238AU - RAM® Quick-Grip™	RAM-HOL-SAM59U - Non-Powered RAM-HOL-SAM9PU - Powered
Sonim	XP5s	-	RAM-HOL-SNM1U - Non-Powered, Non-Locking RAM-HOL-SNM1PU - Powered, Non-Locking RAM-HOL-SNM1LU - Non-Powered, Locking RAM-HOL-SNM1PLU - Powered, Locking
	XP8	-	RAM-HOL-SNM2U - Non-Powered, Non-Locking RAM-HOL-SNM2PU - Powered, Non-Locking RAM-HOL-SNM2LU - Non-Powered, Locking RAM-HOL-SNM2PLU - Powered, Locking
Unitech	EA500	RAM-HOL-UN4U	-
	EA602	RAM-HOL-UN4U	-
	PA730	RAM-HOL-UN4U	-
Zebra	MC40	RAM-HOL-UN10BU	-
	MC45	RAM-HOL-UN7BU	-
	MC55	RAM-HOL-UN10BU	RAM-HOL-SYM3PECU
	MC67	RAM-HOL-UN10BU	RAM-HOL-SYM3PECU
	TC51	-	RAM-HOL-ZE6U
	TC52	-	RAM-HOL-ZE6U
	TC55	RAM-HOL-UN10BU	-
	TC56	-	RAM-HOL-ZE6U
	TC57	-	RAM-HOL-ZE6U
	TC70	-	RAM-HOL-ZE7U - Non-Locking RAM-HOL-ZE7CLU - Combo Lock RAM-HOL-ZE7LU - Key Lock
	TC72	-	RAM-HOL-ZE7U - Non-Locking RAM-HOL-ZE7CLU - Combo Lock RAM-HOL-ZE7LU - Key Lock
	TC75	-	RAM-HOL-ZE7U - Non-Locking RAM-HOL-ZE7CLU - Combo Lock RAM-HOL-ZE7LU - Key Lock
	TC77	-	RAM-HOL-ZE7U - Non-Locking RAM-HOL-ZE7CLU - Combo Lock RAM-HOL-ZE7LU - Key Lock

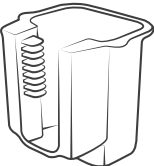
SCANNER GUN COMPATIBILITY GUIDE

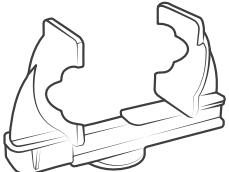
MAKE	MODEL	 RAM® POWER-GRIP™	 RAM® DROP-N-LOCK™	 RAM® QUICK-DRAW™
ATID	AT870	RAP-396U	-	RAM-HOL-QD1U
Cognex	MX-1000	RAP-450U	-	RAM-HOL-QD1U
Cognex	MX-1502	RAP-450U	-	RAM-HOL-QD1U
Datalogic	Falcon FX3	-	RAP-317U	RAM-HOL-QD1U
Datalogic	Falcon X4	RAP-450U	-	RAM-HOL-QD1U
Datalogic	Memor 1	RAP-396U	-	RAM-HOL-QD1U
Datalogic	Memor 10	RAP-396U	-	RAM-HOL-QD1U
Datalogic	PowerScan	RAP-396U	-	RAM-HOL-QD1U
Datalogic	Scorpio	-	RAP-317U	RAM-HOL-QD1U
Datalogic	Skorpio X3	-	RAP-317U	RAM-HOL-QD1U
Datalogic	Skorpio X4	RAP-450U	-	RAM-HOL-QD1U
Dolphin	CN80	RAP-450U	-	RAM-HOL-QD1U
Honeywell	CK75	RAP-450U	-	RAM-HOL-QD1U
Honeywell	Dolphin 99GX	-	RAP-317U	RAM-HOL-QD1U
Honeywell	Granit Series	RAP-396U	-	-
Honeywell	Intermec CK3R	-	RAP-317U	RAM-HOL-QD1U
Honeywell	Intermec CK3X	-	RAP-317U	RAM-HOL-QD1U
Honeywell	Intermec CK70	-	RAP-317U	RAM-HOL-QD1U
Honeywell	Intermec CK71	-	RAP-317U	RAM-HOL-QD1U
Honeywell	Intermec CN70	-	RAP-317U	RAM-HOL-QD1U
Honeywell	Intermec CN70e	-	RAP-317U	RAM-HOL-QD1U
Janam	XG200	RAP-450U	-	RAM-HOL-QD1U
MobileDemand	xTablet A680	RAP-450U	-	RAM-HOL-QD1U
Motorola	MC9190-G	RAP-450U	-	RAM-HOL-QD1U
Unitech	PA730	RAP-450U	-	RAM-HOL-QD1U
Zebra	DS3500 Series	RAP-396U	-	RAM-HOL-QD1U
Zebra	DS3608	RAP-396U	-	RAM-HOL-QD1U
Zebra	LI3608/3678	RAP-396U	-	RAM-HOL-QD1U
Zebra	LS3408	RAP-396U	-	RAM-HOL-QD1U
Zebra	MC9190-Z	-	RAP-317U	RAM-HOL-QD1U
Zebra	MC9200	RAP-450U	-	RAM-HOL-QD1U
Zebra	MC9300	RAP-450U	-	RAM-HOL-QD1U
Zebra	MT2000	RAP-396U	-	RAM-HOL-QD1U

TABLET PC & VEHICLE MOUNTED COMPUTER COMPATIBILITY GUIDE



MAKE	MODEL	HOLDER	BALL ADAPTER	NOTES
Advantech Dlog	DLT-V8310	-	RAM-D-2461U	-
	DLT-V8312	-	RAM-D-2461U	-
	DLT-V8315	-	RAM-D-2461U	-
	MTC 6/10	-	RAM-D-2461U	-
	MTC 6/12	-	RAM-D-2461U	-
	MTC 6/15	-	RAM-D-2461U	-
	PWS-870	-	RAM-D-2461U	-
	TREK 303	-	RAM-202U	-
	TREK 306	-	RAM-2461U	-
	TREK 722	-	RAM-202U	-
	TREK 723	-	RAM-202U	-
	TREK 753	-	RAM-2461U	-
	TREK 773	-	RAM-D-2461U	-
XMT 5/10	-	RAM-D-2461U	-	
XMT 5/7	-	RAM-D-2461U	-	
AML	Guardian	-	RAM-202U	-
	Phoenix	-	RAM-202U	-
Datalogic	Rhino 10	-	RAM-D-2461U	-
	Rhino II	-	RAM-D-2461U	-
Glacier Computer	Everest S9000	-	RAM-D-246U	-
	Kodiak	-	RAM-D-246U	-
Honeywell	CV41	-	RAM-D-254U	-
	CV61	-	RAM-202-IN15	Custom
	Thor CV30	-	RAM-D-202U	-
	Thor CV31	-	RAM-D-202U	-
	Thor VM1	-	RAM-D-254U	-
	Thor VM2	-	RAM-D-254U	-
	Thor VM3	-	RAM-D-254U	-
	Thor VX8	-	RAM-D-202U	-
Thor VX9	-	RAM-D-202U	-	
JLT Mobile	MT1010	-	RAM-D-246U	-
	V1214N	-	RAM-D-2461U	-
	Verso 12	-	RAM-D-2461U	-
	Verso 15	-	RAM-D-2461U	-
	Verso+ 10	-	RAM-D-2461U	-
Juniper	CT8	RAM-HOL-TAB29U / RAM-HOL-TABL29U	-	-
	Mesa 2	RAM-HOL-TAB12U + RAM-HOL-TAB-RISER1U	-	Risers are required for this holder to be compatible
Mobile Demand	xTablet C1200	-	RAM-D-254U	-
	xTablet C1300	-	RAM-D-254U	-
	xTablet Flex 8 & 10	-	RAM-202U	-
	xTablet T1200	-	RAM-D-254U	-
	xTablet T1400	-	RAM-D-254U	-
	xTablet T1600	-	RAM-D-254U	-
	xTablet T7200	-	RAM-202U	-
Motion Computing	C5	RAM-HOL-MOT9PU RAM-HOL-MOT9U RAM-HOL-MOT9PLU	-	-
	CL920	RAM-HOL-MOT11PU	-	-
	F5	RAM-HOL-MOT9PU RAM-HOL-MOT9U RAM-HOL-MOT9PLU	-	-
Noax	C12 Industrial PC	-	RAM-D-2461U	-
	C15 Industrial PC	-	RAM-D-2461U	-
Panasonic	Toughbook CF-19	RAM-234-PAN2P	-	-
	Toughbook H2	RAM-HOL-PAN5PU	-	-
	Toughbook U1	RAM-HOL-PAN4PU	-	-
	Toughpad FZ-A1	RAM-HOL-TABL10U	-	-
	Toughpad FZ-B2	RAM-HOL-TABL12U	-	-
	Toughpad FZ-G1	RAM-HOL-TABL19U	-	-
	Toughpad FZ-M1	RAM-HOL-TABL12U	-	-
Winmate	FM10	-	RAM-2461U	Attaches to Factory Dock
	M700	-	RAM-2461U	Attaches to Factory Dock
	M9020	-	RAM-202U	Attaches to Factory Dock
	M970D	-	RAM-2461U	Attaches to Vesa Mounting Kit
Xplore Technologies	Bobcat	-	RAM-246U	Direct fit to Xplore X DockG3
	RangerX	-	RAM-246U	Direct fit to Xplore X DockG2
	XC6 DM & DML	-	RAM-2461U	Direct Fit to Xplore xDock Pro
	XC6 DMCR	-	RAM-2461U	Direct Fit to Xplore xDock Pro
	XC6 DMSR	-	RAM-2461U	Direct Fit to Xplore xDock Pro
	XC6 M2	-	RAM-2461U	Direct Fit to Xplore xDock Pro
Zebra	8585	-	RAM-D-2461U	-
	ET1 Enterprise Tablet	RAM-HOL-TABL4U	-	-
	ET50/55	RAM-HOL-TABL25U	-	-
	VC70N0	-	RAM-D-2461U	-
	VC80	-	RAM-D-202U-23	-
	VH10	-	RAM-D-202U-23	-

INTELLISKIN® COMPATIBILITY & GDS® PRODUCT CHARTS

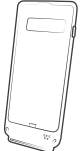
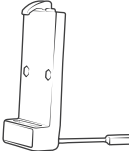
PHONES

MAKE	MODEL	INTELLISKIN®	VEHICLE DOCK	NOTES
				
Samsung	Samsung Galaxy A10 (SM-A105)	RAM-GDS-SKIN-SAM56	RAM-GDS-DOCK-V1U	
	Galaxy A20e SM-A202	RAM-GDS-SKIN-SAM53	RAM-GDS-DOCK-V1CU	
	Galaxy J3 (2017)	RAM-GDS-SKIN-SAM31	RAM-GDS-DOCK-V1U	
	Galaxy J3 (2018)	RAM-GDS-SKIN-SAM44	RAM-GDS-DOCK-V1U	
	Galaxy J7 (2017)	RAM-GDS-SKIN-SAM32	RAM-GDS-DOCK-V1U	
	Galaxy J7 (2018)	RAM-GDS-SKIN-SAM45	RAM-GDS-DOCK-V1U	
	Galaxy Note 9	RAM-GDS-SKIN-SAM42	RAM-GDS-DOCK-V1CU	
	Galaxy S10	RAM-GDS-SKIN-SAM46	RAM-GDS-DOCK-V1CU	
	Galaxy S10+	RAM-GDS-SKIN-SAM48	RAM-GDS-DOCK-V1CU	
	Galaxy S10e	RAM-GDS-SKIN-SAM47	RAM-GDS-DOCK-V1CU	
	Galaxy S7	RAM-GDS-SKIN-SAM22	RAM-GDS-DOCK-V1U	
	Galaxy S8	RAM-GDS-SKIN-SAM28	RAM-GDS-DOCK-V1CU	
	Galaxy S8+	RAM-GDS-SKIN-SAM30	RAM-GDS-DOCK-V1CU	
	Galaxy S9	RAM-GDS-SKIN-SAM39	RAM-GDS-DOCK-V1CU	
	Galaxy S9	RAM-GDS-SKIN-SAM39HD	RAM-GDS-DOCK-V1CU	IntelliSkin® HD™
	Galaxy Xcover 4	RAM-GDS-SKIN-SAM37	RAM-GDS-DOCK-V1U	
	Galaxy Xcover 4s	RAM-GDS-SKIN-SAM51	RAM-GDS-DOCK-V1CU	

TABLETS

MAKE	MODEL	INTELLISKIN®	VEHICLE DOCK	NOTES
				
Apple	iPad 5th Gen	RAM-GDS-SKIN-AP15	RAM-GDS-DOCKL-V2-AP8U	
	iPad 6th Gen	RAM-GDS-SKIN-AP15	RAM-GDS-DOCKL-V2-AP8U	
	iPad Air 2	RAM-GDS-SKIN-AP8	RAM-GDS-DOCKL-V2-AP8U	
	iPad Air 3	RAM-GDS-SKIN-AP16	RAM-GDS-DOCKL-V2-AP16U	
	iPad mini 4	RAM-GDS-SKIN-AP7	RAM-GDS-DOCKL-V2-AP7U	
	iPad mini 5	RAM-GDS-SKIN-AP27	RAM-GDS-DOCKL-V2-AP27U	
	iPad Pro 10.5	RAM-GDS-SKIN-AP16	RAM-GDS-DOCKL-V2-AP16U	
	iPad Pro 11	RAM-GDS-SKIN-AP23	RAM-GDS-DOCKL-V2-AP23U	
	iPad Pro 12.9 3rd Gen	RAM-GDS-SKIN-AP24	RAM-GDS-DOCKL-V2-AP24U	
	iPad Pro 9.7	RAM-GDS-SKIN-AP12	RAM-GDS-DOCKL-V2-AP8U	
Samsung	Galaxy S2 8.0	RAM-GDS-SKIN-SAM18U	RAM-GDS-DOCKL-V2-SAM18U	
	Galaxy S2 9.7	RAM-GDS-SKIN-HS-SAM19U	RAM-GDS-DOCKL-V2-SAM19U + RAM-HOL-TAB-RISER2U	GDS® HandStand™ included
	Galaxy S2 9.7	RAM-GDS-SKIN-SAM19U	RAM-GDS-DOCKL-V2-SAM19U	
	Galaxy Tab A 10.1 (2019) SM-T510/515	RAM-GDS-SKIN-SAM50	RAM-GDS-DOCKL-V2-SAM49U	
	Galaxy Tab A 10.1 (2019) SM-T510/515	RAM-GDS-SKIN-SAM50-NG	RAM-GDS-DOCKL-V9-OMT1U	Next Generation IntelliSkin®
	Galaxy Tab A 10.1 SM-T580	RAM-GDS-SKIN-SAM23	RAM-GDS-DOCKL-V2-SAM23U	
	Galaxy Tab A 10.1 with S Pen SM-P580	RAM-GDS-SKIN-SAM26	RAM-GDS-DOCKL-V2-SAM23U	
	Galaxy Tab A 10.5 (2018) SM-T590/597	RAM-GDS-SKIN-SAM43	RAM-GDS-DOCKL-V2-SAM43U	
	Galaxy Tab A 7.0	RAM-GDS-SKIN-SAM24	RAM-GDS-DOCKL-V2-SAM24U	
	Galaxy Tab A 8.0 (2015) SM-T350/355	RAM-GDS-SKIN-SAM16U	RAM-GDS-DOCKL-V2-SAM16U	
	Galaxy Tab A 8.0 (2017) SM-T380/385	RAM-GDS-SKIN-SAM35	RAM-GDS-DOCKL-V2-SAM35U	
	Galaxy Tab A 8.0 (2018) SM-T387	RAM-GDS-SKIN-SAM40	RAM-GDS-DOCKL-V2-SAM40U	
	Galaxy Tab A 8.0 (2018) SM-T387	RAM-GDS-SKIN-SAM40-NG	RAM-GDS-DOCKL-V9-OMT1U	Next Generation IntelliSkin®
	Galaxy Tab A 8.0 (2019)	RAM-GDS-SKIN-SAM55-NG	RAM-GDS-DOCKL-V9-OMT1U	Next Generation IntelliSkin®
	Galaxy Tab Active Pro	RAM-GDS-SKIN-SAM54-NG	RAM-GDS-DOCKL-V9-OMT1U	Next Generation IntelliSkin®
	Galaxy Tab Active2	RAM-GDS-SKIN-SAM29	RAM-GDS-DOCKL-V2-SAM29CU	*Not compatible with GDS® HandStand™ or Shoulder Strap
	Galaxy Tab Active2	RAM-GDS-SKIN-SAM29-NG	RAM-GDS-DOCKL-V9-OMT1U	Next Generation IntelliSkin®
	Galaxy Tab Active2	RAM-GDS-SKIN-SAM29H	RAM-GDS-DOCKL-V2-SAM29CU	
	Galaxy Tab E 8.0 SM-T377/378	RAM-GDS-SKIN-SAM21	RAM-GDS-DOCKL-V2-SAM21U	
	Galaxy Tab E 8.0 SM-T377/378	RAM-GDS-SKIN-SAM21-NG	RAM-GDS-DOCKL-V9-OMT1U	Next Generation IntelliSkin®
Galaxy Tab E 9.6	RAM-GDS-SKIN-SAM20U	RAM-GDS-DOCKL-V2-SAM20U		
Galaxy Tab S3 9.7	RAM-GDS-SKIN-SAM27	RAM-GDS-DOCKL-V2-SAM27U		
Galaxy Tab S4 10.5" SM-T830/835/837	RAM-GDS-SKIN-SAM41	RAM-GDS-DOCKL-V2-SAM41U		
Galaxy Tab S5e SM-T720/725	RAM-GDS-SKIN-SAM49	RAM-GDS-DOCKL-V2-SAM49U		

GDS® PRODUCT CHARTS



GDS® DESKTOP DOCKS

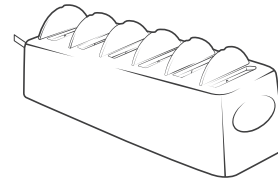

PART NUMBER	DESCRIPTION	NOTES
RAM-GDS-DOCK-D2U	Single Desktop Dock with usub 2.0	
RAM-GDS-DOCK-D1U	Single Desktop Dock with usub 3.0	
RAM-GDS-DOCK-D2CU	Single Desktop Dock with Type-C	
RAM-GDS-DOCK-4G1PU	4-Port Desktop Dock - 110 Watts	
RAM-GDS-DOCK-6G1PU	6-Port Desktop Dock - 110 Watts	
RAM-GDS-DOCK-G7U	GDS® Slide Dock™ - Drill Down	
RAM-GDS-DOCK-G7MU	GDS® Slide Dock™ - Magnetic	
RAM-GDS-DOCK-G7BU	GDS® Slide Dock™ - Module Only	
RAM-GDS-DOCK-D2C-NDU	Single Desktop Dock with Type-C	For Next Gen IntelliSkin®
RAM-GDS-DOCK-6G1P-NGU	6-Port Desktop Dock - 110 Watts	For Next Gen IntelliSkin®
RAM-GDS-DOCK-G7-NGU	GDS® Slide Dock™ - Drill Down	For Next Gen IntelliSkin®
RAM-GDS-DOCK-G7M-NGU	GDS® Slide Dock™ - Magnetic	For Next Gen IntelliSkin®
RAM-GDS-DOCK-G7B-NGU	GDS® Slide Dock™ - Module Only	For Next Gen IntelliSkin®

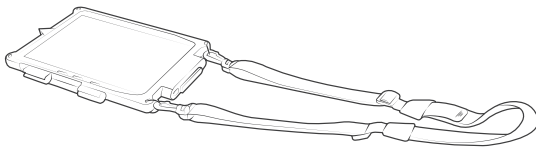

GDS® ERGO™

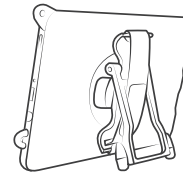

PART NUMBER	DESCRIPTION
RAM-GDS-BRUSH-01U	IntelliSkin® Contact Brush
RAM-GDS-HS1U	GDS® HandStand™
RAM-GDS-HS1-RISER2U	GDS® HandStand™ with Vehicle Dock Risers
RAM-GDS-SS1U	GDS® Shoulder Strap
RAM-GDS-STU	GDS® Wrist Strap

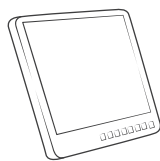

GDS® ECOSYSTEM™



PART NUMBER	DESCRIPTION
RAM-GDS-HUB-TYPEC-01	GDS® Tough-Hub™ with USB Type-C for Vehicles
RAM-GDS-HUB-TYPEC-02	GDS® Tough-Hub™ with USB Type-C for Desktop
RAM-GDS-MON-13-1	GDS® View™ Monitor with 13.3" Touch Screen
RAM-HOL-TAB-KEYU	RAM® Tab-Tite™ Holder for GDS® Keyboard™
RAM-HOL-TABL-KEYU	RAM® Tab-Lock™ Holder for GDS® Keyboard™
RAM-KEY2-USB	GDS® Keyboard™ with Track Pad
RAM-KEY4-USB	GDS® Keyboard™ with 10 Key
RAM-SPEAK-A01	GDS® Audio™ Amplified Speaker

RAM® MOUNTS PRODUCT CHARTS

HOLDERS

DEVICE	PRODUCT LINE	PART ID	HOLDER DIMENSIONS	HOLE PATTERN	COMPATIBLE BALL ADAPTERS
Phone / Handheld	RAM® Quick-Grip™	RAM-HOL-PD3U	Height Range: 4.75" - 5.75" Width Range: 2.19" - 3.25" Max Depth: .72"	2-Hole AMPS	RAM-B-238U
	RAM® Quick-Grip™ XL	RAM-HOL-PD4U	Height Range: 5.75" - 8.25" Width Range: 2.625" - 3.625" Max Depth: .72"	2-Hole AMPS	RAM-B-238U
	RAM® X-Grip®	RAM-HOL-UN10BU	Width Range: 1.75" - 4.5" Depth Range: .875" max	-	B Size 1" Ball Included
	RAM® X-Grip®	RAM-HOL-UN7BU	Width Range: 1.875" - 3.25" Depth Range: .875" max	-	B Size 1" Ball Included
	RAM® Finger-Grip™	RAM-HOL-UN4U	Height Range: 7.25" max (using optional supports) Width Range: 1.25" - 3.5" Max Depth: 1.5"	2-Hole AMPS 4-Hole AMPS	RAM-B-238U
Printer	RAM® Quick-Draw™	RAM-VPR-102	Max Height: 1.75" Width Range: 8" - 14.5"	4-Hole AMPS	RAM-202U
	RAM® Quick-Draw™	RAM-VPR-103	Max Height: 2.5" Width Range: 9" - 15.5"	4-Hole AMPS	RAM-202U
	RAM® Quick-Draw™	RAM-VPR-104	Max Height: 1.75" Width Range: 5.625" - 9.5"	4-Hole AMPS	RAM-202U
	RAM® Quick-Draw™	RAM-VPR-105	Max Height: 2.5" Width Range: 6.625" - 10.5"	4-Hole AMPS	RAM-202U
Scanner Gun	RAM® Drop-N-Lock™	RAP-317U			
	RAM® Power-Grip™	RAP-396U	Max Width: 3.47" Max Length: 2.16" Max Depth: 4.9"	4-Hole AMPS	RAM-202U
	RAM® Power-Grip™ XL	RAP-450U	Max Width: 3.96" Max Length: 2.66" Max Depth: 7.43"	4-Hole AMPS	RAM-202U
Tablet	RAM® Tough-Tray™ II	RAM-234-6	Width Range: 8.56" - 11.12" Side Arm Clamp Height: 2.75" max Tray Depth: 6"	4-Hole AMPS	RAM-202U
	RAM® Tab-Lock™	RAM-HOL-TABL-LGU	Height Range: 8.5" - 11.75" Width Range: 7.75" - 8.25" Depth Range: .56" - 1.1"	4-Hole AMPS	RAM-202U
	RAM® Tab-Lock™	RAM-HOL-TABL-SM2U	Height Range: 8.08" - 11" Width Range: 3.77" - 5.88" Depth Range: .13" - .67"	4-Hole AMPS	RAM-202U
	RAM® Tab-Lock™	RAM-HOL-TABL10U	Height Range: 9.75" - 12" Width Range: 6.38" - 8.62" Depth Range: .13" - 1"	4-Hole AMPS	RAM-202U
	RAM® Tab-Lock™	RAM-HOL-TABL12U	Height Range: 7.125" - 9.5" Width Range: 5.06" - 5.68" Depth Range: .13" - 1"	4-Hole AMPS	RAM-202U
	RAM® Tab-Lock™	RAM-HOL-TABL16U	Height Range: 7.5" - 9.875" Width Range: 3.625" - 5.05" Depth Range: .13" - .82"	4-Hole AMPS	RAM-202U
	RAM® Tab-Lock™	RAM-HOL-TABL17U	Height Range: 9.5" - 11.75" Width Range: 6.375" - 8.25" Depth Range: .13" - 1.1"	4-Hole AMPS	RAM-202U
	RAM® Tab-Lock™	RAM-HOL-TABL18U	Height Range: 7.5" - 10.125" Width Range: 3.75" - 4.7" Depth Range: .13" - .43"	4-Hole AMPS	RAM-202U
	RAM® Tab-Lock™	RAM-HOL-TABL19U	Height Range: 10.75" - 13.375" Width Range: 6.5" - 7.75" Depth Range: .13" - .93"	4-Hole AMPS	RAM-202U
	RAM® Tab-Lock™	RAM-HOL-TABL20U	Height Range: 9.25" - 12.125" Width Range: 6.55" - 7.43" Depth Range: .3" - .875"	4-Hole AMPS	RAM-202U
	RAM® Tab-Lock™	RAM-HOL-TABL21U	Height Range: 7.42" - 10" Width Range: 3.6" - 4.56" Depth Range: .13" - .72"	4-Hole AMPS	RAM-202U
	RAM® Tab-Lock™	RAM-HOL-TABL22U	Height Range: 7.38" - 9.99" Width Range: 3" - 4.25" Depth Range: .13" - .4"	4-Hole AMPS	RAM-202U
	RAM® Tab-Lock™	RAM-HOL-TABL23U	Height Range: 8.32" - 10.92" Width Range: 4.43" - 5.3" Depth Range: .13" - .62"	4-Hole AMPS	RAM-202U
	RAM® Tab-Lock™	RAM-HOL-TABL24U	Height Range: 8.08" - 10.69" Width Range: 3.77" - 4.96" Depth Range: .13" - .36"	4-Hole AMPS	RAM-202U

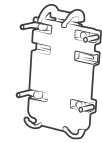

RAM® QUICK-GRIP™



RAM® X-GRIP®

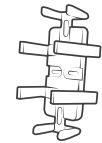

RAM® FINGER-GRIP™

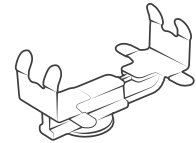

RAM® QUICK-DRAW™



RAM® DROP-N-LOCK™

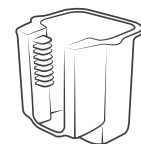

RAM® POWER-GRIP™

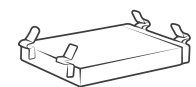

RAM® TOUGH-TRAY™ II

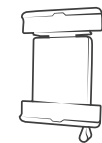

RAM® TAB-LOCK™

RAM® MOUNTS PRODUCT CHARTS

HOLDERS

DEVICE	PRODUCT LINE	PART ID	HOLDER DIMENSIONS	HOLE PATTERN	COMPATIBLE BALL ADAPTERS
Tablet	RAM® Tab-Lock™	RAM-HOL-TABL25U	Height Range: 9.64" - 12.32" Width Range: 6.13" - 7.4" Depth Range: .13" - .7"	4-Hole AMPS	RAM-202U
		RAM-HOL-TABL26U	Height Range: 9.38" - 12.11" Width Range: 5.55" - 7" Depth Range: .13" - .34"	4-Hole AMPS	RAM-202U
		RAM-HOL-TABL27U	Height Range: 7.88" - 10.38" Width Range: 4.3" - 5.3" Depth Range: .37" max	4-Hole AMPS	RAM-202U
		RAM-HOL-TABL28U	Height Range: 9" - 11.75" Width Range: 5.5" - 6.65" Depth Range: .315" max	4-Hole AMPS	RAM-202U
		RAM-HOL-TABL29U	Height Range: 8.25" - 11" Width Range: 5" - 5.88" Depth Range: .3" - .67"	4-Hole AMPS	RAM-202U
		RAM-HOL-TABL2U	Height Range: 7" - 9.625" Width Range: 4" - 5.31" Depth Range: .13" - .56"	4-Hole AMPS	RAM-202U
		RAM-HOL-TABL30U	Height Range: 7.82" - 10.375" Width Range: 4.75" - 5.375" Depth Range: .3125" max"	4-Hole AMPS	RAM-202U
		RAM-HOL-TABL3U	Height Range: 8.5" - 11.125" Width Range: 6.38" - 7.75" Depth Range: .13" - .56"	4-Hole AMPS	RAM-202U
		RAM-HOL-TABL4U	Height Range: 7.375" - 10" Width Range: 4" - 5.31" Depth Range: .13" - 1.06"	4-Hole AMPS	RAM-202U
		RAM-HOL-TABL6U	Height Range: 8.625" - 11.25" Width Range: 6.05" - 6.8" Depth Range: .13" - .5"	4-Hole AMPS	RAM-202U
		RAM-HOL-TABL8U	Height Range: 9" - 11.5" Width Range: 6.38" - 8.31" Depth Range: .13" - 1.12"	4-Hole AMPS	RAM-202U
		RAM-HOL-TABL9U	Height Range: 10.625" - 12.625" Width Range: 6.38" - 9.25" Depth Range: .13" - 2"	4-Hole AMPS	RAM-202U
	RAM® X-Grip®	RAM-HOL-UN11U	Max Height: 10.25" (using optional supports) Width Range: 7.25" - 8.75" Max Depth: .875"	4-Hole AMPS 75mm VESA	RAM-202U RAM-D-2461U
		RAM-HOL-UN8BCU	Width Range: 2.5" - 5.75" Depth Range: .875" max	-	C Size 1.5" Ball Included
		RAM-HOL-UN8BU	Width Range: 2.5" - 5.75" Depth Range: .875" max	-	B Size 1" Ball Included
RAM-HOL-UN9U		Max Height: 10.25" (using optional supports) Width Range: 6.25" - 8.1" Max Depth: .875"	4-Hole AMPS 75mm VESA	RAM-202U RAM-D-2461U	

BALL PLATE ADAPTERS

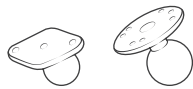

BALL SIZE	PART NUMBER	HOLE PATTERN
B Size 1"	RAM-B-202U	4-Hole AMPS
	RAM-B-238U	2-Hole AMPS
C Size 1.5"	RAM-202U	4-Hole AMPS
	RAM-202U-22	1.5" x 1.5"
	RAM-202U-23	1.5" x 2.5"
	RAM-202U-24	1.5" x 3.5"
	RAM-202U-25	1.5" x 4.5"
	RAM-202U-IN1	4-Hole AMPS
	RAM-238U	2-Hole AMPS
	RAM-2461U	75 x 75mm VESA
	RAM-2461U-IN1	75 x 75mm VESA
	RAM-2462U	35 x 75mm VESA
RAM-246U	100 x 100mm VESA	

BALL PLATE ADAPTERS

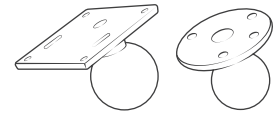

BALL SIZE	PART NUMBER	HOLE PATTERN
D Size 2.25"	RAM-D-202U	3-Hole Pattern, 2.75" Diameter
	RAM-D-202U-22	1.5" x 1.5"
	RAM-D-202U-23	1.5" x 2.5"
	RAM-D-202U-24	1.5" x 3.5"
	RAM-D-202U-25	1.5" x 4.5"
	RAM-D-202U-IN1	3-Hole Pattern, 2.75" Diameter
	RAM-D-202U-SYM1	6-Hole Pattern, 2.75" Diameter
	RAM-D-2461U	75 x 75mm VESA
	RAM-D-2462U	35 x 75mm VESA
	RAM-D-246U	100 x 100mm VESA
	RAM-D-246U-IN1	100 x 100mm VESA
	RAM-D-254U	4-Hole AMPS
	E Size 3.38"	RAM-E-202U
RAM-E-202U-IN1		3-Hole Pattern, 2.75" Diameter
RAM-E-202U-SYM1		6-Hole Pattern, 2.75" Diameter
RAM-E-246U		100 x 100mm VESA
RAM-E-246U-IN1		100 x 100mm VESA

RAM® MOUNTS PRODUCT CHARTS

OVERHEAD GUARD BASES

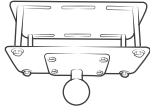

PART NUMBER	BALL SIZE
RAM-335	No ball
RAM-335-246	C Size 1.5"
RAM-335-D-246	D Size 2.25"
RAM-335-E-346	E Size 3.38"

SQUARE POST CLAMP BASES

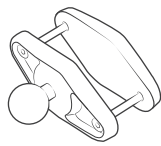

PART NUMBER	BALL SIZE	MAX WIDTH
RAM-B-247U-15	B Size 1"	1.5"
RAM-B-247U-17	B Size 1"	1.7"
RAM-B-247U-2	B Size 1"	2"
RAM-B-247U-25	B Size 1"	2.5"
RAM-B-247U-3	B Size 1"	3"
RAM-B-247U-4	B Size 1"	4"
RAM-247U-15	C Size 1.5"	1.5"
RAM-247U-17	C Size 1.5"	1.7"
RAM-247U-2	C Size 1.5"	2"
RAM-247U-25	C Size 1.5"	2.5"
RAM-247U-3	C Size 1.5"	3"
RAM-247U-4	C Size 1.5"	4"
RAM-247U-5	C Size 1.5"	5"
RAM-D-247U-15	D Size 2.25"	1.5"
RAM-D-247U-17	D Size 2.25"	1.7"
RAM-D-247U-2	D Size 2.25"	2"
RAM-D-247U-25	D Size 2.25"	2.5"
RAM-D-247U-3	D Size 2.25"	3"
RAM-D-247U-4	D Size 2.25"	4"
RAM-D-247U-5	D Size 2.25"	5"
RAM-E-247U-25	E Size 3.38"	2.5"

DRILL- DOWN BASES

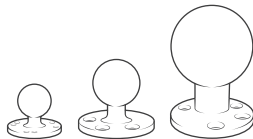

PART NUMBER	BALL SIZE	HOLE PATTERN
RAM-B-202U	B Size 1"	4-Hole AMPS
RAM-202U	C Size 1.5"	4-Hole AMPS
RAM-2461U	C Size 1.5"	75 x 75mm VESA
RAM-D-246U	D Size 2.25"	100 x 100mm VESA
RAM-E-246U	E Size 3.38"	100 x 100mm VESA
RAM-D-202U	D Size 2.25"	3-Hole Pattern, 2.75" Diameter
RAM-E-202U	E Size 3.38"	3-Hole Pattern, 2.75" Diameter

SOCKET ARMS

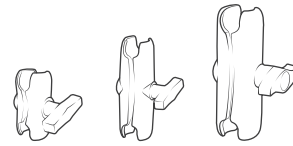

PART ID	BALL SIZE	OVERALL LENGTH	SOCKET TO SOCKET LENGTH
RAM-B-201U-A	B Size 1"	2.42"	1.75"
RAM-B-201U	B Size 1"	3.73"	3.00"
RAM-B-201U-C	B Size 1"	6.00"	5.31"
RAM-201U-B	C Size 1.5"	3.56"	2.50"
RAM-201U	C Size 1.5"	5.69"	4.66"
RAM-201U-D	C Size 1.5"	9.13"	8.0"
RAM-D-201U-C	D Size 2.25"	5.10"	3.60"
RAM-D-201U	D Size 2.25"	8.44"	6.88"
RAM-D-201U-E	D Size 2.25"	12.98"	11.41"
RAM-E-201U-D	E Size 3.38"	7.31"	4.975"
RAM-E-201U	E Size 3.38"	12.625"	9.875"

RAIL CLAMP AND POST BASES



PART NUMBER	DESCRIPTION	BALL SIZE	CLAMP RANGE
RAM-271U-12	Backing Plate Base	C Size 1.5"	1.25" - 1.785" diameter
RAM-271U-2	Backing Plate Base	C Size 1.5"	2" - 2.5" diameter
RAM-D-271U-12	Backing Plate Base	D Size 2.25"	1.25" - 1.785" diameter
RAM-D-271U-2	Backing Plate Base	D Size 2.25"	2" - 2.5" diameter
RAM-B-231ZU	U-Bolt Base	B Size 1"	.5" - 1.25" diameter
RAM-231ZU	U-Bolt Base	C Size 1.5"	.5" - 1.25" diameter
RAM-B-231-1U	U-Bolt Base	B Size 1"	1" - 1.25" diameter
RAM-231-1U	U-Bolt Base	C Size 1.5"	1" - 1.25" diameter
RAM-B-235U	Double U-Bolt Base	B Size 1"	1" - 1.25" diameter
RAM-235U	Double U-Bolt Base	C Size 1.5"	1" - 1.25" diameter
RAM-D-235U	Double U-Bolt Base	D Size 2.25"	1" - 1.25" diameter
RAM-235-1U	Double U-Bolt Base	C Size 1.5"	1.25" - 1.5" diameter
RAM-D-235-1U	Double U-Bolt Base	D Size 2.25"	1.25" - 1.5" diameter
RAP-B-400U	RAM® Tough-Claw™	B Size 1"	.625" - 1.5" diameter
RAP-B-404U	RAM® Tough-Claw™	B Size 1"	1" - 1.875" diameter
RAP-B-401U	RAM® Tough-Claw™	B Size 1"	1" - 2.25" diameter
RAP-B-401LU	RAM® Tough-Claw™ - Locking	B Size 1"	1" - 2.25" diameter
RAP-400U	RAM® Tough-Claw™	C Size 1.5"	.625" - 1.5" diameter
RAP-404U	RAM® Tough-Claw™	C Size 1.5"	1" - 1.875" diameter
RAP-401U	RAM® Tough-Claw™	C Size 1.5"	1" - 2.25" diameter
RAP-401LU	RAM® Tough-Claw™ - Locking	C Size 1.5"	1" - 2.25" diameter
RAM-B-108BU	Hose Clamp Base	B Size 1"	1" - 2.1" diameter
RAM-108BU	Hose Clamp Base	C Size 1.5"	1" - 2.1" diameter

RAM® TOUGH-MAG™

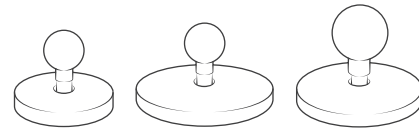

PART NUMBER	BALL SIZE	DIAMETER	WEIGHT CAPACITY
RAM-B-MAG66U	B Size 1"	66mm	1 lb. Max
RAM-B-MAG88U	B Size 1"	88mm	1 lb. Max
RAM-MAG88U	C Size 1.5"	88mm	3 lbs. Max

LOCKING KNOBS

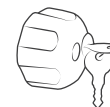

PART NUMBER	DESCRIPTION
RAP-S-KNOB3U	RAM® Pin-Lock™ Security Knob for B Size Arms
RAP-S-KNOB5U	RAM® Pin-Lock™ Security Knob for C Size Arms
RAP-S-NUT5U	RAM® Pin-Lock™ Security Nut for D Size & E Size Arms
RAM-KNOB3LU	Key Lock Knob for B Size Arms
RAM-KNOB5LU	Key Lock Knob for C Size Arms

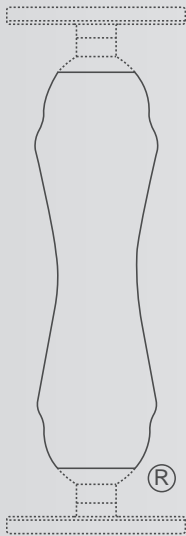

THE SHAPE THAT STARTED IT ALL

RAM® double socket arms with their distinctive Hourglass Shape are recognized globally as a symbol of the reliability, quality, and durability of this line of products. The Hourglass Shape is a registered trademark of National Products Inc.



LEARN MORE

The unique RAM® Mounts system offers a full line of interchangeable mounting bases, extensions, device adapters, and accessories to secure your devices where you want it. See all of the innovative products and solutions RAM® manufactures at rammount.com.

RAM® Mounts is a division of National Products Inc.

Lifetime Warranty
 Patents and Trademarks
rammount.com/ip



THE DISTINCTIVE “D” PRODUCT SHAPE
 of the GDS® connector is a trademark of National Products Inc.



THE DISTINCTIVE RAM® “X-GRIP®”
 product shape is a trademark of National Products Inc.



THE DISTINCTIVE “DOUBLE DELTA”
PRODUCT SHAPE
 is a trademark of National Products Inc.



NPI-CAT-MATHAND20
MARCH 2020

