



INSTALLATION INSTRUCTIONS

Hot Fox—In-Line/In-Tank Fuel Warmer

B-458—01/11

READ INSTRUCTIONS COMPLETELY BEFORE BEGINNING INSTALLATION

Models covered by these instructions include:

HFG 08-10			
HFG 10-12	SHFT-2512-10-12	SHH-1844-09	TWHF 10-12
HFG 12-14	SHFT-2512-12-14	SHH-1844-11	TWHF 12-14
HFG 13-15	SHFT-2512-13-15	SHH-1844-12	TWHF 13-15
HFG 14-16	SHFT-2512-14-16	SHH-1844-13	TWHF 14-16
HFG 17-19	SHFT-2512-17-19	SHH-1844-16	TWHF 17-19
HFG 20-22	SHFT-2512-20-22	SHH-1844-19	TWHF 20-22
HFG 22-24	SHFT-2512-22-24	SHH-1844-21	TWHF 22-24
HFG 24-26	SHFT-2512-24-26	SHH-1844-23	TWHF 24-26
HFG 26-28	SHFT-2512-26-28	SHH-1844-25	TWHF 27-29
		SHH-1844-26	
		SHH-1844-31	

- **Warms fuel in tank and standpipe**
- **Has fast standpipe fuel warming, by its unique spiral “turbulating” fuel passage**
- **Fits standard fuel sending unit opening**
- **Can be rotated in tank for easy hose alignment**
- **Optional thermostat available**

TOOLS NEEDED

- Needle nose pliers
- 5/32” hex wrench (3.8” drive preferred)
- 3/8” drive air wrench and 5/16” socket
- High speed drill with 7/32” drill bit
- 400 rpm drill with 1/2” chuck
- 1 5/8” hole saw (such as Arctic Fox T-519 Saw with T-510 Arbor)

IMPORTANT PRECAUTIONS

- Avoid mistakes. Read these instructions completely **BEFORE YOU BEGIN**.
- Before you cut a hole in the fuel tank:
 - Know where all baffles are located
 - Verify the swing radius of the fuel gauge arm.
 - Determine precisely where the plumbing lines will run.
- Check all parts against the parts listing.

IMPORTANT CONSIDERATIONS

- On dual-tank single draw systems with a 1” (25mm) I.D. or smaller crossover line, we recommend that the “Hot Fox” draw and fuel return be in the same tank. If you don’t do this, fuel could possibly discharge from the non-draw tank’s vent. Also, the tank could be damaged due to “pressurizing” if the crossover line becomes obstructed or if the crossover line valves are inadvertently shut off. Never return the fuel to the opposite tank from which it is drawn unless the fuel crossover line is 1” (25mm) I.D. or larger, or if the crossover line is equipped with manual shutoff valves. [This suggestion applies to **any** heated or non-heated standpipe draw system, and not just to the “Hot Fox”.]

- The spacing of the “Hot Fox” Warmer mounting holes is the same as the standard spacing for most fuel gauge sending units. You can either:

Mount the warmer in an existing, unused, sending gauge opening. In this case, skip Steps 7 through 16 below. OR,

Install the Warmer in an appropriate new location, cutting holes as outlined below.

CAUTION: To insure proper sealing of the Hot Fox when direct mounting to the tank, the A-834 back-up plate must be used. Attempting to secure the Hot Fox to the tank with sheet metal screws or fasteners other than those provided with the kit can result in gasket leakage.

- On aluminum fuel tanks having a wall thickness of 0.100” (2.5mm) or less, or steel tanks having a wall thickness of 0.075” (2mm) (14-gauge) or less, which **don’t** have a reinforced opening available, use the appropriate adapter kit from Arctic Fox—See Page 5. On thicker walled tanks, mount the “Hot Fox” directly in the tank wall using the A-834 Backing Plate.

PLAN THE INSTALLATION

1. On dual-tank systems, determine which tank will be the “draw tank”. Dual suction dual return systems require two “Hot Foxes”.

In the respective tank(s), locate the fuel gauge, baffles, and any other potential obstructions for the Warmer. Choose a location for the Warmer where there will be no contact with any of these items.
2. Dual-tank systems with dual “Hot Foxes” should also have dual return lines. When plumbing dual-tank, dual-draw systems, it is critical that the suction lines leading to the left and right tanks be of equal length and elevation, to help assure equal fuel draw from each tank. [This suggestion applies to **all** dual-draw systems, heated or non-heated].
3. Remove the original fuel draw hose from the tank (or crossover line) and plug the tank or crossover line opening. Route the draw hose to the potential “Hot Fox” location to be sure it will be long enough.
4. Determine where you are going to run the hoses to plumb the Warmer to the engine cooling system. The Warmer’s hoses should tap into the same passages as the cab heater. Also determine the types of fittings required to connect to the “Hot Fox”. See “Connect the Plumbing” on page 4 and “Plumbing Accessories on pages 5 & 6.
5. The end of the Warmer should be 1” (25mm) above the bottom of the tank. Install the 2” (51mm) long extension nipple if necessary, and cut it to the proper length. See Fig. 1. If you are going to use an optional spacer kit (page 5) you must compensate for the spacer thickness when cutting the nipple. Deburr the end of the nipple.
6. Clean the tank area where the Warmer will be installed.
7. Set the backing plate on the fuel tank in the location you chose to install the Warmer in Step 1, with the longer side of the threaded nuts facing up.

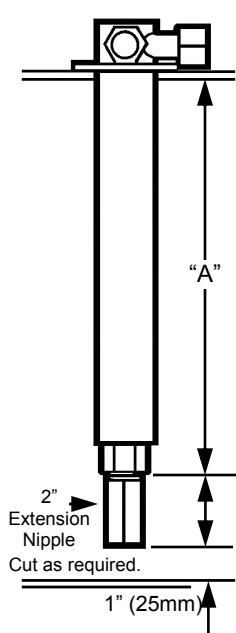

Tank Diameter	Hot Fox Warmer Model			Dimension "A"		
	Standard	Auxiliary Pickup	With Thermostat	No Spacer	KT-875 1/2"	KT-877 1"
08-10" (203-254mm)	HFG 08-10	N/A	N/A	7" (178mm)	6.5" (165mm)	6" (152mm)
10-12" (254-305mm)	HFG 10-12	TWHF 10-12	SHFT-2512-10-12	9" (229mm)	8.5" (216mm)	8" (203mm)
12-14" (305-356mm)	HFG 12-14	TWHF 12-14	SHFT-2512-12-14	11" (279mm)	10.5" (267mm)	10" (254mm)
13-15" (330-381mm)	HFG 13-15	TWHF 13-15	SHFT-2512-13-15	12" (305mm)	11.5" (292mm)	11" (279mm)
14-16" (357-406mm)	HFG 14-16	TWHF 14-16	SHFT-2512-14-16	13" (330mm)	12.5" (318mm)	12" (305mm)
17-19" (432-483mm)	HFG 17-19	TWHF 17-19	SHFT-2512-17-19	16" (406mm)	15.5" (394mm)	15" (381mm)
20-22" (508-559mm)	HFG 20-22	TWHF 20-22	SHFT-2512-20-22	19" (483mm)	18.5" (470mm)	18" (457mm)
22-24" (559-610mm)	HFG 22-24	TWHF 22-24	SHFT-2512-22-24	21" (533mm)	20.5" (521mm)	20" (508mm)
24-26" (610-660mm)	HFG 24-26	TWHF 24-26	SHFT-2512-24-26	23" (584mm)	22.5" (572mm)	22" (559mm)
26-28" (660-711mm)	HFG 26-28	TWHF 26-28	SHFT-2512-26-28	25" (635mm)	24.5" (622mm)	24" (610mm)
27-29" (686-737mm)	HFG 27-29	TWHF 27-29	SHFT-2512-27-29	26" (660mm)	25.5" (648mm)	25" (635mm)

Fig. 1

IMPORTANT: For most efficient heat transfer, use the longest "Hot Fox" available for your tank diameter/depth. The end of the Warmer (or extension nipple) should be 1" from the bottom of the tank.

- (Continued) - For future reference, the notch on the backing plate should point toward the front of the vehicle. See Fig. 2. Using the two A-608 self-drilling self-tapping screw provided, temporarily attach the backing plate to the tank. See Fig. 3.
- Drill 7/32" holes through the tank at the four remaining unthreaded hole locations on the backing plate, as shown in Fig. 4.
- Remove the two self-tapping screws and lift off the backing plate. Re-drill the self-tapping screw holes to 7/32".

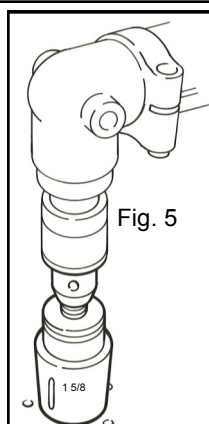
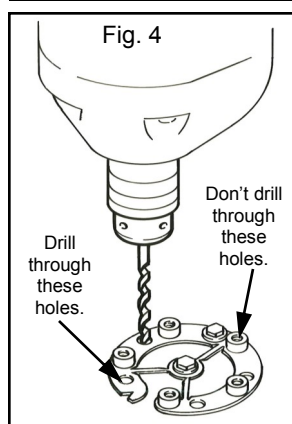
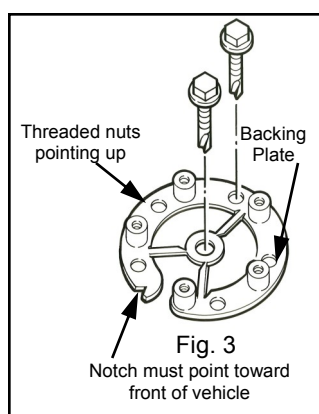
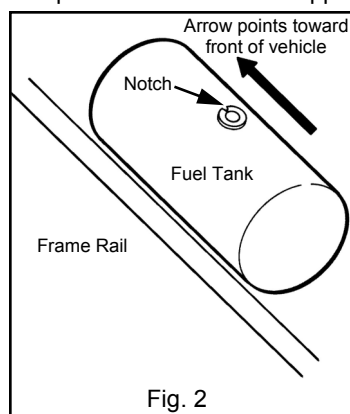

CUT THE OPENING FOR THE WARMER

- Using the center self-tapping screw's hole as a pilot, cut a 1-5/8" diameter hole in the tank with a hole saw. See Fig. 5. Deburr the hole.

IMPORTANT: To keep most of the saw cuttings out of the tank, grease the inside and outside edges of the hole saw blade. Blow away chips as they accumulate.

On steel tanks, chips which fall into the tank can usually be cleaned up with a magnet. Chips from aluminum tanks may have to be flushed out—however, small amounts of chips tend to pass through the fuel line and lodge harmlessly in the primary fuel filter.

CAUTION: If the fuel system doesn't have a filter between the tank and transfer pump, **all chips MUST BE REMOVED from inside the fuel tank to avoid damaging the fuel pump!**

- With a needle nose pliers, grip the center washer of the backing plate, as in Fig. 6. Using a twisting motion, break the washer out of the plate.
- Hold the backing plate with the threaded nuts facing downward. Bend tabs up at about a 45° angle, as in Fig. 7.
- Hold one of the tabs with a needle nose pliers, and insert the backing plate into the 1-5/8" hole in the tank. When installing, insert the end **without** a notch into the tank opening first. See Fig. 8.
- Again position the backing plate so the notch points toward the **front** of the vehicle.

Hold the plate in place, using your fingers or pliers. Align the holes in the tank with the holes in the plate.

Install the five mounting bolts finger tight to temporarily secure the plate in place. See Fig. 9.

- With the needle nose pliers, bend all three tabs up and over the tank edge as shown in Fig. 10. You don't have to bend the tabs over tightly, as long as they will hold the plate in place until the "Hot Fox" is installed. However, they must be pulled far enough to allow the warmer to slide into the opening.
- Remove the five bolts, but **don't** discard them.

INSTALL THE WARMER

17. Lay the A-841 gasket over the tank opening, with its notch pointing toward the front of the vehicle. Make sure all five holes in the gasket line up with the holes in the tank (and backing plate).
18. Hold the Warmer over the tank opening and verify the direction that its plumbing connections are pointed. Verify what type (barbed, threaded) and Orientation (straight, 90°, 45°) of fittings will be required—refer to page 6.
19. The “Hot Fox” is designed with a low profile to fit where clearance above the tank is limited. However, if the plumbing connections must be raised **higher** above the tank, an optional A-875 Spacer kit (page 5) is available with longer bolts and an extra gasket.
20. Install the appropriate plumbing fittings determined in Step 18. To install a fitting, place the fitting into a vise and turn the “Hot Fox” onto the fitting. Then tighten using a 1” open-end wrench on the hex coupling of the Warmer. Refer to Fig. 11.

CAUTION: Never squeeze the “Hot Fox” body in a vise, as its electropolished surface may be scarred.

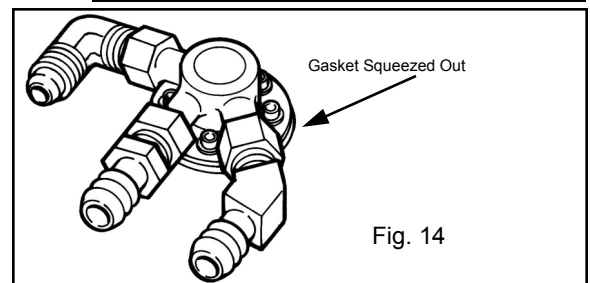
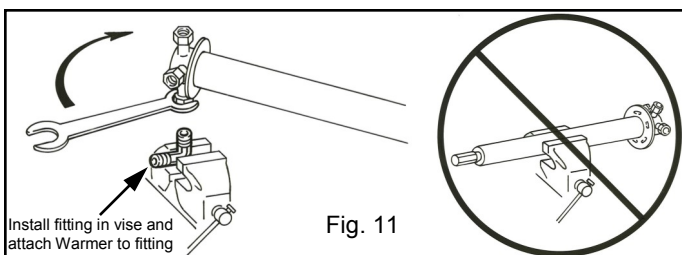
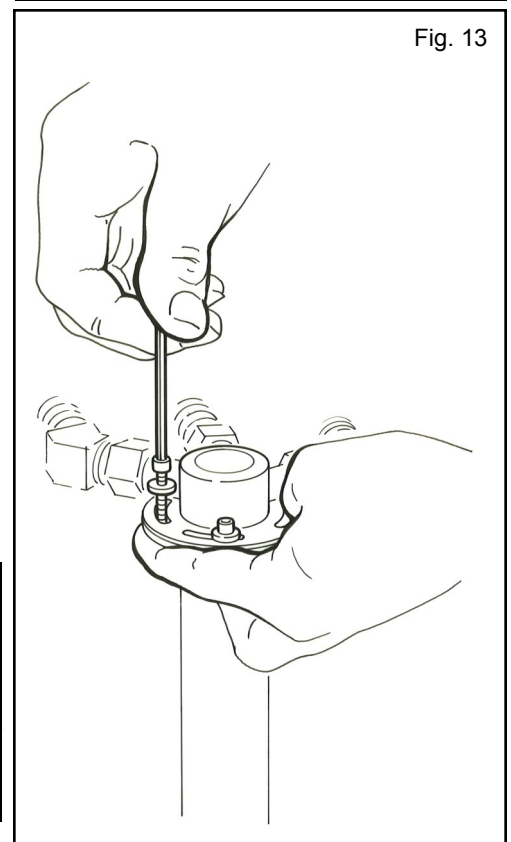
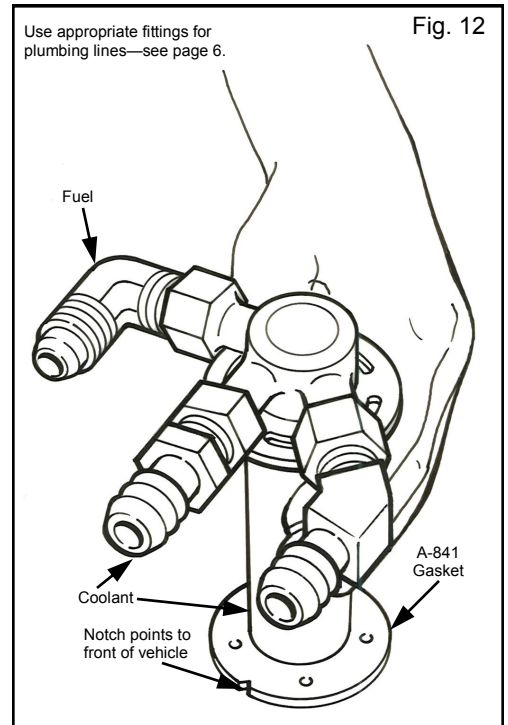
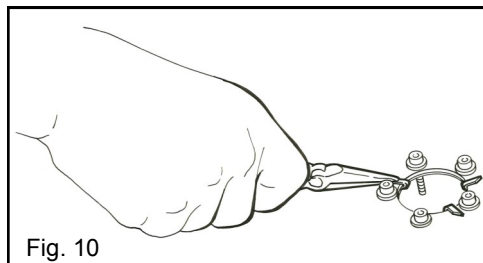
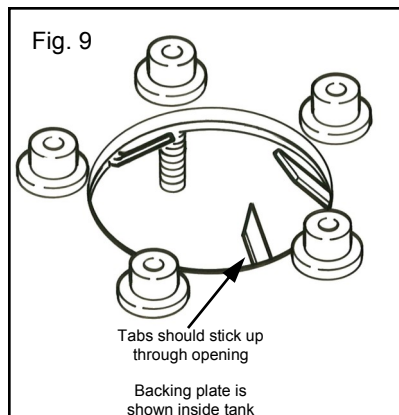
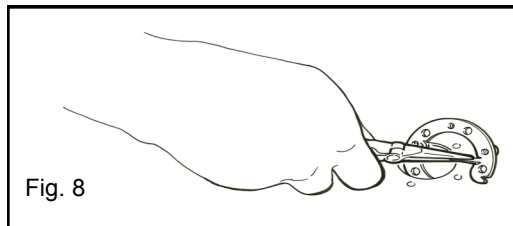
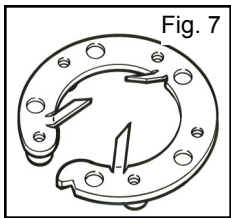
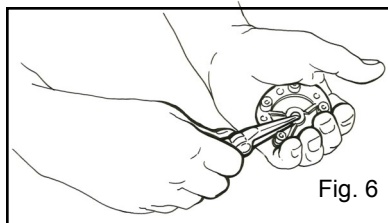

21. Insert the Warmer partway into the tank opening, in the same orientation determined in Step 18. See Fig. 12.
22. Insert the five mounting bolts, with washers, through the slots in the warmer flange, and use a hex (Allen) wrench to “pop” them through the gasket. See Fig. 13.
23. Insert the Warmer (with gasket) all the way into the tank opening, lining up the bolts with the threaded holes in the tank.
Verify that the Warmer is still oriented in the direction determined in Step 18, and partially screw the five bolts into the backing plate. Finger tighten the bolts with an Allen wrench.
23. Gradually tighten alternate bolts until they are all securely tightened and the gasket is partially “squeezed out” all around the mounting plate (torque the bolts to 90 in.-lbs (10.2 nm) maximum. See Fig 14.

**CONNECT THE PLUMBING
FUEL LINE**

25. Connect the original fuel line to the FUEL port on the “Hot Fox”. See Fig. 16.
NOTE: Arctic Fox Insultube is available to insulate the fuel line. It will minimize temperature drop between the engine and the fuel tank. For more information, refer to the Arctic Fox product catalog

COOLANT SUPPLY

26. Obtain hot coolant from a pipe plug opening on the engine pressure side of the cooling system. Route the coolant to either COOLANT port on the “Hot Fox”. See Fig. 16.
SUGGESTION: If you are not sure which pipe plug ports on the engine are the coolant supply and return, locate the hose connections for the cab heater and plumb into ports in those same cavities.

CAUTION: For most efficient Warmer operation, provide a separate coolant loop. Avoid using Tee's or Wye's in the coolant supply and return lines (thereby paralleling with another accessory). However, if all engine access ports are being used for other accessories, you may have to consider a Tee or Wye as an option. Any Tee used must be at least 1/2” NPT or larger, and should be installed at the engine port—not in the coolant line itself. Any Wye should be inserted into existing hoses as shown in Fig. 15, so the provide the least restriction of coolant flow to the “Hot Fox”. Note also that plumbing a fuel warmer in series with a cab heater may drastically reduce the amount of heat transferred to the fuel.

NOTE: If an in-line fuel warmer or heated fuel/water separator is used in conjunction with the “Hot Fox”, both can be plumbed in series in the same coolant loop. However, the hot coolant from the engine should first pass through the in-line warmer, then on to the “Hot Fox”. This will allow maximum anti-waxing protection to the primary fuel filter on initial startup after an extended “cold-soak” period.

27. The hot coolant supply to the Warmer should be shut off when ambient temperatures reach +40°F (+4°C). Series S-400 or S-440 automatic shut-off thermostats, and manual shut-off valves such as the Arctic Fox A-275, A-276, A-461, A-526, or A-527, are available from your dealer.

COOLANT RETURN

28. Route coolant from a COOLANT port on the “Hot Fox” back to an engine pipe plug on the suction side of the engine cooling system.

NOTE: For additional cold weather protection, especially below 0°F (-18°C), Arctic Fox Insultube can be added to the coolant lines to reduce heat loss.

THERMOSTAT (Optional)

29. If you want to add a thermostat in the coolant loop, check with Arctic Fox for an S-400 series Shut-Off Thermostat. The S-400 stops coolant flow when the fuel flowing through it reaches optimum temperature.

FINAL CHECK

30. Before operating the unit, **re-check carefully** that the fuel line is connected to the FUEL port on the “Hot Fox”, and the coolant from the engine is connected to the COOLANT ports. See Fig. 16.

If you have any questions call Arctic Fox for assistance. (1-800-654-5382)

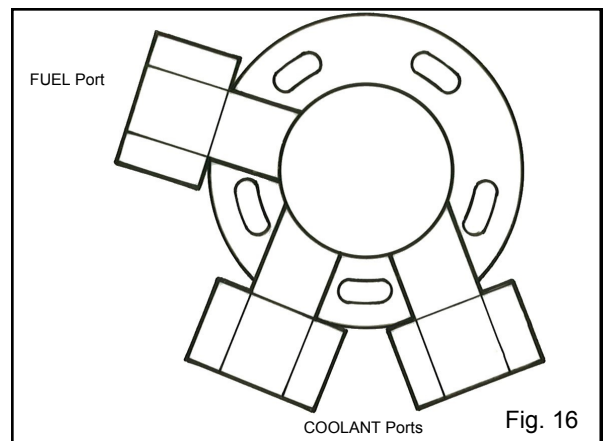
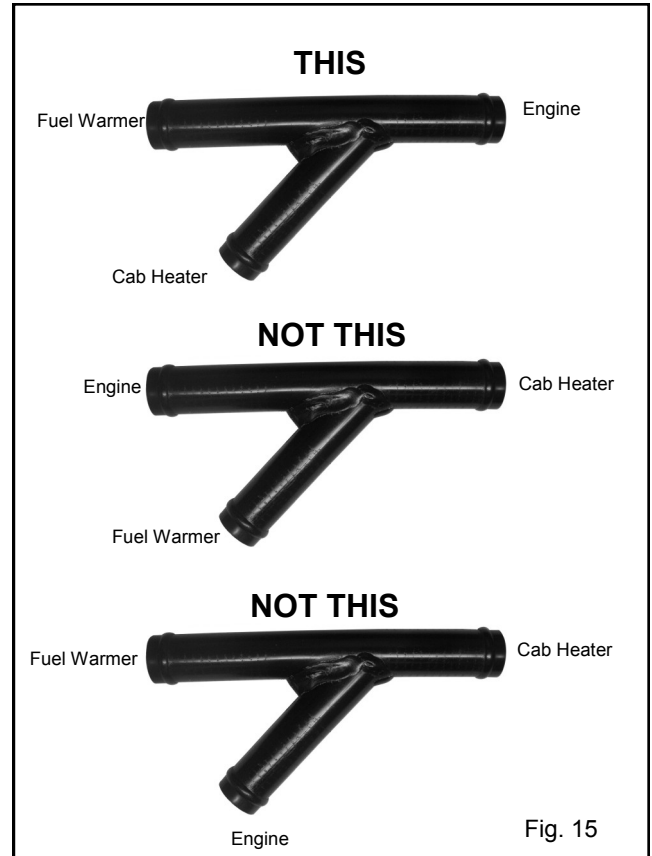

VALVES

BRASS BODY GATE VALVE (Round Handle)



- A-527—3/8" NPT x 5/8" (16mm) Hose Barb
- A-279—1/2" NPT x 5/8" (16mm) Hose Barb
- A-275—1/2" NPT x 3/4" (19mm) Hose Barb

BRASS BODY GATE VALVE (Tee Handle)



- A-526—3/8" NPT x 5/8" (16mm) Hose Barb

BRASS BODY BALL VALVE (Full Flow)

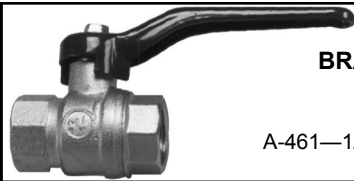

- A-461—1/2" NPT x 1/2" NPT

INSULTUBE LINE INSULATION

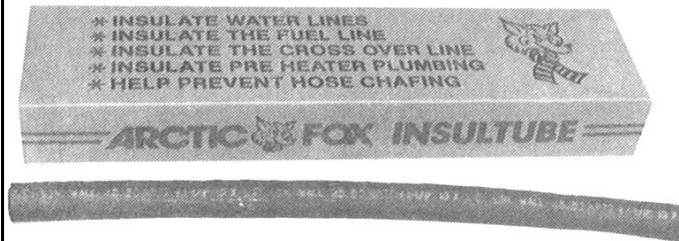

Fuel and Coolant Line Insulation

- A-705—Kit (four A-706 sticks, plus tie straps)
- A-706—1-1/8" (29mm) I.D. x 1/2" (13mm) wall x 6' (1.8m) stick
- A-712—1-3/8" (35mm) I.D. x 1/2" (13mm) wall x 6' (1.8m) stick
- A-713—2" (51mm) I.D. x 1/2" (13mm) wall x 6' (1.8m) stick
- A-714—3" (76mm) I.D. x 1/2" wall x 6' (1.8m) stick
- A-720—1-1/8" (29mm) I.D. x 1/2" (13mm) wall x 125' (38m) roll
- A-721—1-3/8" (35mm) I.D. x 1/2" (13mm) wall x 125' (38m) roll
- A-1710—1/2" (13mm) I.D. x 1/2" (13mm) wall x 6' (1.8m) stick
- A-1711—5/8" (16mm) I.D. x 1/2" (13mm) wall x 6' (1.8m) stick
- A-1712—3/4" (19mm) I.D. x 1/2" (13mm) wall x 6' (1.8m) stick
- A-1789—7/8" (22mm) I.D. x 1/2" (13mm) wall x 6' (1.8m) stick, split, self-sealing
- A-1791—2-1/2" (64mm) I.D. x 1/2" (13mm) wall x 6' (1.8m) stick

INSULTUBE ACCESSORIES

- A-707—Tie strap, weather resistant, 14" (356mm) long
- A-711—Tie strap, heavy duty, weather resistant, 14" (356mm) long
- A-1790—Adhesive to join Insultube ends, 1/2 pint (0.24l)

HOT FOX ADAPTER KITS

These kits are for bolt-in installations, and include the adapter plate, tank mounting bolts, and tan-to-adapter gasket. Kits KT-826F, KT-827C, and KT-831 CS also include backup plate assemblies, attaching hardware, and tank drilling templates.

- KT-825V—5" round, 8-hole, fits Volvo, GM OEM 4-3/8" BC flange & misc. others.
- KT-826F—6" square, fits Arctic Fox mount for flat top tanks.
- KT-827C—6" square for 22-29" (560-737mm) round tanks.
- KT-828D—"D" Shaped 10-hole for flat top tanks, fits Tokheim 10-hole flange.
- KT-829K—120mm, round 10-hole flange, fit Kenworth OEM 104.5mm B.C. flange.
- KT- 831CS—6" square, for 14- 18" (356-457mm) round tanks.
- KT-832L—6.5" round, 10-hole, fist misc. automotive/industrial OEM 5.75" flanges.
- KT-833DC—"D" Shaped 10-hole for round tanks, fits Tokheim 10-hole flange.

"HOT FOX" REPLACEMENT PARTS

Item #	Part #	Description
1	A-857	Bolt, socket head, 10-32x1", SST (qty. 5)
2	A-861	Washer, oversize, SST (qty. 5)
3	N/A	Warmer (Order complete "Hot Fox")
4	A-841	Gasket
5	A-834	Plate, back up, for mounting of "Hot Fox" in tank wall
6	A-858	Nipple, extension, 2" (51mm)
N/A	A-608	Screw, self-drilling tap (installation only) not shown
N/A	A-870	Plate, blank cover (fits standard fuel sending gauge opening) not shown

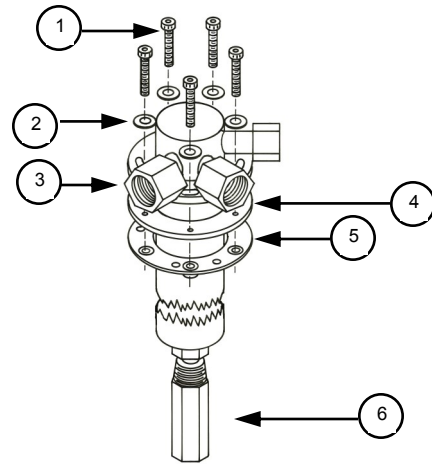

"HOT FOX" SPACER KITS (Optional)

KT-875 1/2" Spacer

Item #	Part #	Description
1	A-863	Bolt, socket head, 10-32x1-1/2", SST (qty. 5)
2	A-875	Plate, 1/2" Spacer
3	A-841	Gasket

KT-877 1" Spacer

Item #	Part #	Description
1	A-869	Bolt, socket head, 10-32 x 2", SST (qty. 5)
2	A-877	Plate, 1" Spacer
3	A-841	Gasket

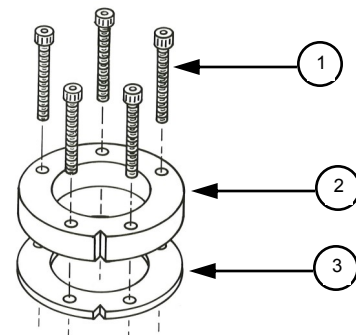

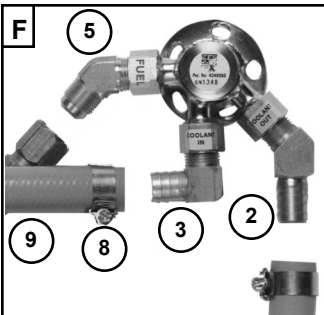
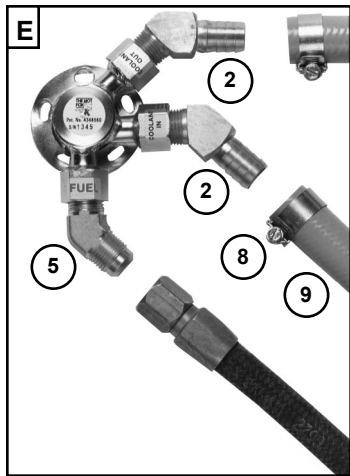
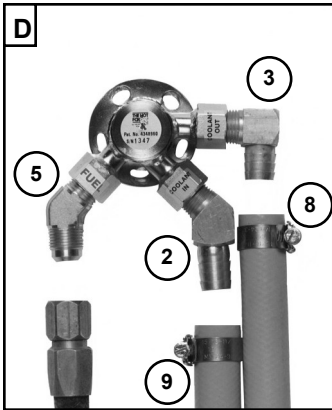
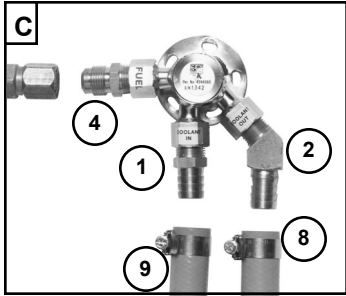
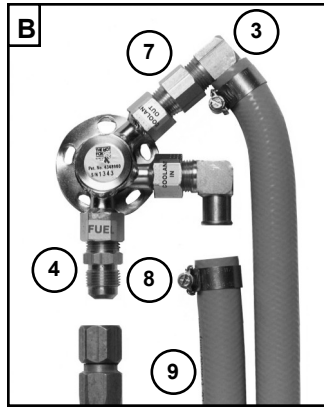
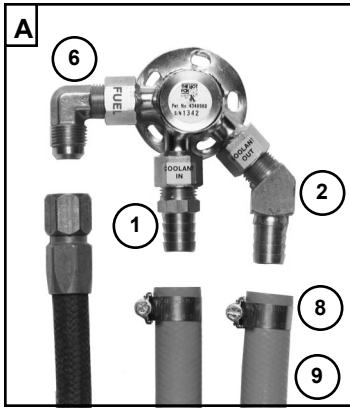

PLUMBING ACCESSORIES FOR TYPICAL CONFIGURATIONS		
Item	Part	Description
1	A-630	Adapter, brass, 1/2" NPT x 5/8" (16mm) hose barb
	A-652	Adapter, brass, 1/2" NPT x 3/4" (19mm) hose barb
2	A-657	Adapter, brass, 45° elbow, 1/2" NPT x 5/8" (16mm) hose barb
	A-658	Adapter, brass, 45° elbow, 1/2" NPT x 3/4" (19mm) hose barb
	A-257	Adapter, brass, 45° street elbow, 1/2 NPT x 1/2 NPT
3	A-631	Adapter, brass, 90° elbow, 1/2 NPT x 5/8" (16mm) hose barb
	A-653	Adapter, brass, 90° elbow, 1/2 NPT x 3/4" (19mm) hose barb
4	A-287	Connector, brass, 1/2 NPT x 1/2" flare male (for #8 wire braid hose)
	A-285	Connector, brass, 1/2 NPT x 5/8" flare male (for #10 wire braid hose)
	A-278	Connector, brass, 1/2 NPT x 3/4" flare male (for #12 wire braid hose)
5	A-291	Elbow, brass, 45°, 1/2 NPT x 1/2" flare male (for #8 wire braid hose)
	A-292	Elbow, brass, 45°, 1/2 NPT x 5/8" flare male (for #10 wire braid hose)
	A-293	Elbow, brass, 45°, 1/2 NPT x 3/4" flare male (for #12 wire braid hose)
6	A-281	Elbow, brass, 90°, 1/2 NPT x 1/2" flare male (for #8 wire braid hose)
	A-283	Elbow, brass, 90°, 1/2 NPT x 5/8" flare male (for #10 wire braid hose)
	A-290	Elbow, brass, 90°, 1/2 NPT x 3/4" flare male (for #12 wire braid hose)
7	A-267	Adapter (extension), brass 1/2 NPT male x 1/2 NPT female
8	A-520	Hose clamp, for 9/16" through 1-1/16" silicone or rubber hose (5/8" [16mm] heater hose)
	A-279	Hose clamp, for 1-1/16" through 1-1/4" silicone or rubber hose (3/4" [19mm] heater hose)
9	A-468	Hose, rubber, 5/8" (16mm) D (50' roll)
	A-531	Hose, rubber, 3/4" (19mm) ID (50' roll)
	A-525	Hose, silicone, 5/8" (16mm) ID (50' roll)
	A-530	Hose, silicone, 3/4" (19mm) ID (50' roll)
	A-532	Hose, silicone, insulated, 5/8" (16mm) I.D. (50' roll) - A-525 with A-720 Insultube installed
	A-534	Hose, silicone, insulated, 3/4" (19mm) I.D. (50' roll) - A-530 with A-721 Insultube installed

FIVE-YEAR OR 600,000 MILE WARRANTY

THIS WARRANTY IS EXPRESSLY LIMITED TO PERSONS WHO PURCHASE ARCTIC FOX "HOT FOX" FUEL TANK WARMERS

Arctic Fox "HOT FOX" Fuel Tank Warmers are warranted against defects in materials and workmanship for a period of **five years or 600,000 miles** from date of purchase by the user. This warranty does not cover fuel warmers which are altered or used for a purpose other than that for which they were intended or used in a manner inconsistent with any instructions regarding their use. The exclusive remedy for any unit found to be defective under this Warranty is limited to the repair or replacement of the defective unit without charge, and **Arctic Fox shall NOT be liable for any consequential or incidental damages, including labor charges.** In order to qualify for this Warranty, the alleged, defective unit must be returned directly to the Arctic Fox factory, postage or freight prepaid, and Arctic Fox will return the repaired or replaced unit postage or freight prepaid. Final determination of defects shall be made by Arctic Fox in accordance with procedures established by Arctic Fox. No agent, employee or representative of Arctic Fox has any authority to bind any affirmation, representation or warranty concerning Arctic Fox products except as stated herein.

THERE ARE NO WARRANTIES WHICH EXTEND BEYOND THE DESCRIPTION OF THE EXPRESS NON-CONSUMER PRODUCT WARRANTY AS STATED ABOVE. THE ABOVE WARRANTY IS IN LIEU OF ANY OTHER WARRANTY, EXPRESS OR IMPLIED, AND EXPRESSLY EXCLUDES ANY WARRANTY OF MERCHANTABILITY OR FITNESS FOR A PARTICULAR PURPOSE.