

Renault Master - Opel Movano
Fiat Ducato X290 / Fiat Talento
Nissan Interstar (NV 400) / Nissan Primastar (NV 300)
Renault Trafic > 2014
Opel Vivaro > 2014 - 2019 <
Dacia DOKKER >2019

Codice / Code: **6246604A**

KIT BLOCCHETTO 3 VIE PER 2° EVAPORATORE CON AC ORIGINALE

KIT ADAPTATEURS À 3 VOIES POUR 2° EVAPORATEUR AVEC AC D'ORIGINE

3 WAY ADAPTER KIT FOR 2nd EVAPORATOR WITH ORIGINAL AC

ANPASSEIN BAUSATZ 3 WEGE FÜR 2 VERDAMPFER MIT ORIGINAL-KLIMAANLAGE

KIT ADAPTADOR 3 VIAS PARA 2° EVAPORADOR CON AC ORIGINAL

Istruzioni di montaggio

Instructions pour le montage

Fitting instructions

Einbauanleitungen

Instrucciones de montaje

**DESCRIZIONE SIMBOLOGIA UTILIZZATA / DESCRIPTION DE LA SYMBOLOGIE UTILISÉE
DESCRIPTION OF SYMBOLS USED / BESCHREIBUNG DER VERWENDETEN SYMBOLIK
DESCRIPCIÓN DE LOS SIMBOLOS UTILIZADOS**

1A Riferimento a figura / Référence à la figure / See figure
In Bezug auf Abbildungen / Referencia a la figura

1-1 Riferimento a componenti di fornitura / Référence aux composants de la fourniture
See supplied components / Bezug auf Gelieferte Einbauelemente
Referencia a los componentes de abastecimiento

1 Riferimento a posizione schema elettrico / Référence à la position du schéma électrique
See position in wiring diagram / In Bezug auf Position im Schaltschema
Referencia a la posición del esquema eléctrico



- Lubrificare tutti i raccordi e gli O.R. con il nuovo olio refrigerante prima di collegarli

- Graisser tous les raccords et les O.R. avec le nouveau huile réfrigérant avant de les raccorder

-Lubricate all fittings and O-rings with new refrigerant oil before connecting them

- Alle Verbindungsstücke und OR-Ringe vor deren Verbindung mit dem neuen Kühlmittelöl ölen

- Lubrificar todos los empalmes y los O.R. con el nuevo aceite refrigerante antes de conectarlos

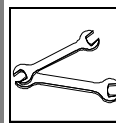

- Per avvitare a fondo o allentare i raccordi tubi gas usare due chiavi per bilanciare coppia di torsione

- Pour visser à fond ou desserrer les raccords des tuyaux gaz, utiliser le deux clés pour équilibrer le couple de torsion

- When tightening or loosening the fittings of the gas pipes, use two wrenches to equalize the torsion couple

- Um die Verbindungsstücke der Kältemittelschläuche gleichmäßig festzuschrauben oder zu lockern, zwei Schlüssel für das Verschraubungspaar verwenden

- Para enrosacar a fondo o aflojar los empalmes tubos gas se deben usar dos llaves para balancear el par de torsión



- Tagliare con utensile appropriato al materiale

- Couper à l'aide d'outil approprié

- Cut with a device suitable for the material

- Mit dem Material entsprechendem Werkzeug schneiden

- Cortar con herramienta apropiada al material

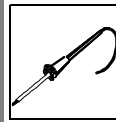

- Stagnare

- Étamer

- Tin

- Verzinnen

- Estañar



- Spianare

- Nivelar

- Flatten out

- Richten

- Nivelar

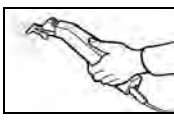

- Tagliare con utensile a lama calda

- Couper à l'aide d'un outil à lame chaude

- Cut using the tool with heated blade.

- Mit Schweißmesserwerkzeug schneiden

- Cortar con útil a hoja caliente

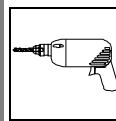

- Forare

- Percer

- To drill

- Durchbohren

- Taladrar

Pos.	ITALIANO	FRANÇAIS	ENGLISH	DEUTSCH	ESPAÑOL
1	Blocchetto 3 vie	Adaptateurs à 3 voies	3 way adapter	Anpasseinbausatz 3 wege	Adaptador 3 vías
2	Sacchetto accessori	Sachet accessoires	Bag of accessories	Säckchen mit Zuberhörteilen	Bolsita accesorios
3	Barra filettata	Barre filetée	Threaded bar	Gewindestange	Barra roscada

VALORI MASSIMI COPPIE DI SERRAGGIO PER VITI (in N.m) VALEURS MAXIMUM DES COUPLES DE SERRAGE POUR LES VIS (en N.m) MAXIMUM VALUES OF THE DRIVING TORQUES FOR SCREWS (in N.m.) MAXIMUMWERT DER VERSCHRAUBUNGEN FÜR DIE SCHRAUBEN (in N.m) VALORES MAXIMOS PAREJAS DE CERRAJE PARA TORNILLOS (en N.m)				
Filettatura Filetage Thread Gewinde Filetadura	Classe dell'acciaio della vite Classe de l'acier de la vis Screw steel class Stahlklassifizierung der Schrauben Clase del acero del tornillo			Apertura in chiave (mm) Ouverture en clef (mm) Wrench opening (mm) Schlüsselöffnung (mm) Abertura en llave (mm)
	5.8	8.8	10.9	
M 4(x0.7)	1.8	2.9	4.2	7
M 5(x0.8)	3.4	5.5	7.5	8
M 6(x1)	6	10	13	10
M 7(x1)	11	16	21	11
M 8 (x1.25)	14	22	30	13
M 8x1	15	23	32	13
M10(x1.5)	27	45	61	17
M10 x1.25	31	50	67	17
M10 x1	33	53	71	17
M12 x1.5	51	78	105	19
M12 x1.25	60	94	125	19
M12 x1.75	84.8	119	143	19
M14 x1.5	80	120	165	22
M16 x1.5	120	185	255	24
M18 x1.5	165	265	350	27
M20 x1.5	225	360	490	30
M22 x1.5	295	480	640	32
M24 x2	390	610	805	36

MATERIALE FORNITO / MATERIEL FOURNI / SUPPLIED MATERIAL / GELIEFERTES MATERIAL / MATERIAL ABASTECIDO

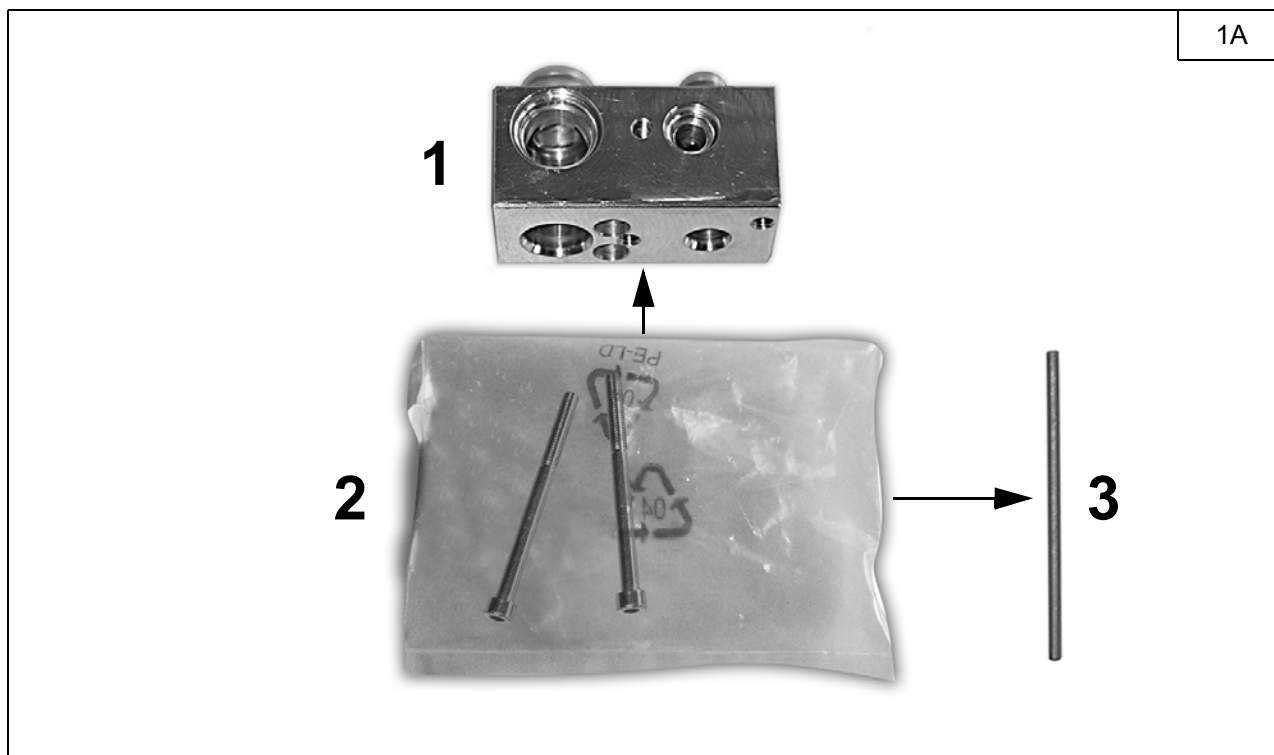

Pos.	Descrizione / D�escription / Description Beschreibung / Descripci�n	Codice Code Kode Codigo
1	Blocchetto a 3 vie	629043501A
2	Sacchetto accessori	6246605A
3	Barra filettata	6232535A

**OPERAZIONI PRELIMINARI / OPERATIONS PRELIMINAIRES / PRELIMINARY OPERATIONS
VORBEREITUNGSARBEITEN / OPERACIONES PRELIMINARES**



(I)
Recuperare il gas refrigerante contenuto nell'impianto AC originale.

(F)
Récupérer le réfrigérant contenu dans le système de AC d'origine.

(GB)
Recover the refrigerant contained in the original AC system.

(D)
Wiederherstellen des im zur Original AC System enthaltene Kältemittel.

(E)
Recuperar el refrigerante contenido en el sistema de AC originales.

R134a

**RECUPERARE
RÉCUPÉRER
RECOVER
GENESEN
RECUPERAR**

2A



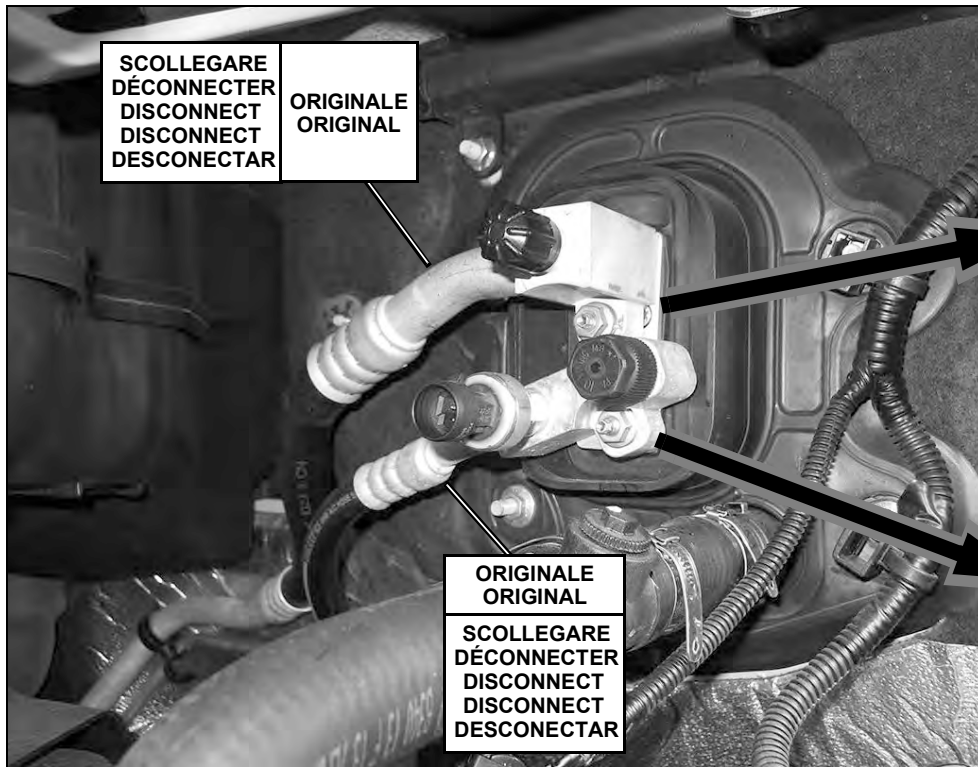

3A

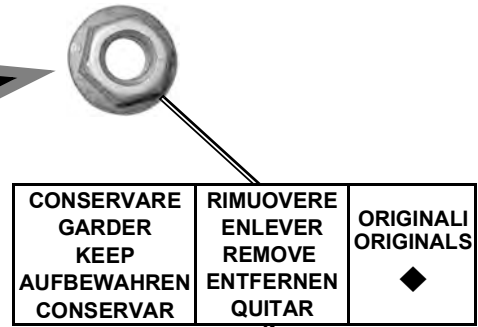

(I)

ATTENZIONE:

Non asportare contemporaneamente le due viti originali dalla valvola di espansione, per evitare la caduta della flangia posta all'interno dell'abitacolo. Seguire le indicazioni di seguito illustrate.

(F)

ATTENTION:

Ne pas enlever simultanément les deux vis d'origine de la vanne d'expansion, pour éviter la chute de la bride située à l'intérieur de l'habitacle. Suivez les instructions énoncées ci-dessous.



(GB)

WARNING:

Do not remove simultaneously the two original screws from the expansion valve, to prevent the fall of the flange located inside the passenger compartment. Follow the instructions illustrated below.

(D)

WARNUNG:

Gleichzeitig Entfernen Sie nicht die zwei Originalschrauben von dem Expansionsventil, um den Fall des Flansches im Fahrgastraum befindet verhindern. Folgen Sie den Anweisungen im Folgenden dargestellt.

(E)

ATENCIÓN:

No quitar simultáneamente los dos tornillos originales de la válvula de expansión, para evitar la caída de la brida situada en el interior del compartimiento de pasajeros. Siga las instrucciones que se indican a continuación.

4A

CONSERVARE GARDER KEEP AUFBEWAHREN CONSERVAR	RIMUOVERE ENLEVER REMOVE ENTFERNEN QUITAR	ORIGINALI ORIGINALS
----------------------------------------------------------	-------------------------------------------------------	------------------------

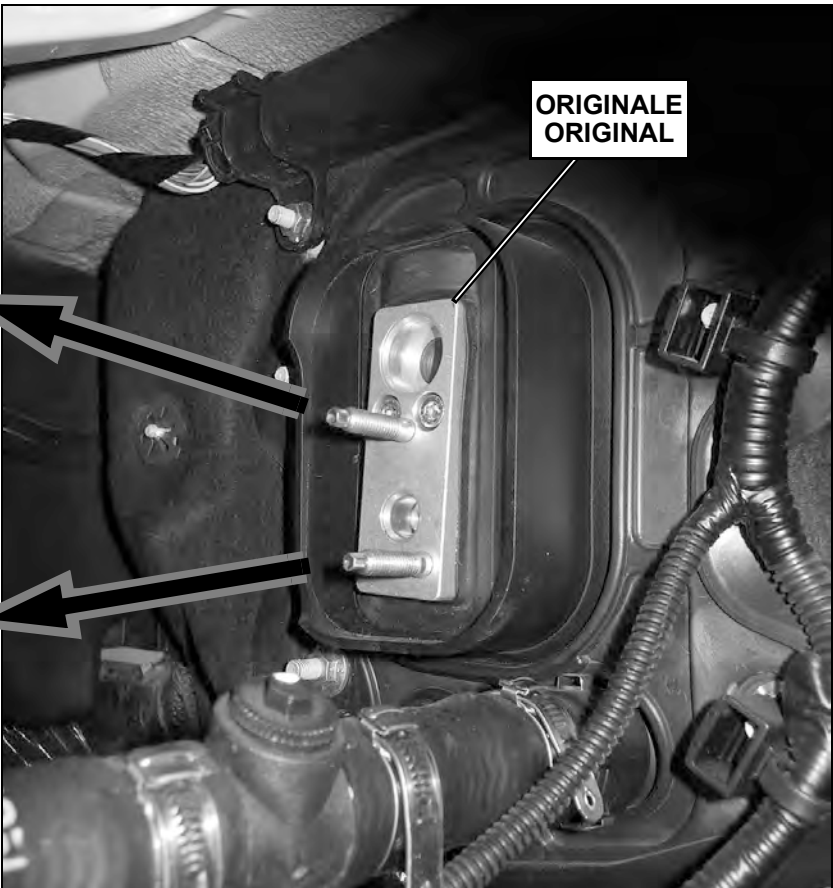
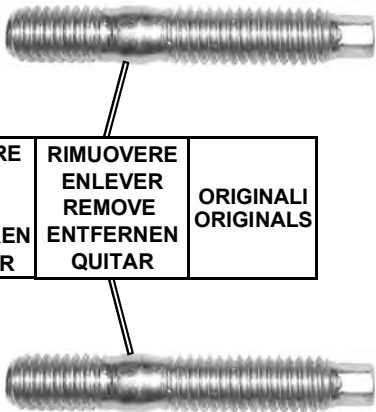

5A

ELIMINARE ELIMINER DISCARD ENTFERNEN ELIMINAR	ORIGINALE ORIGINAL
-----------------------------------------------------------	-----------------------



6A

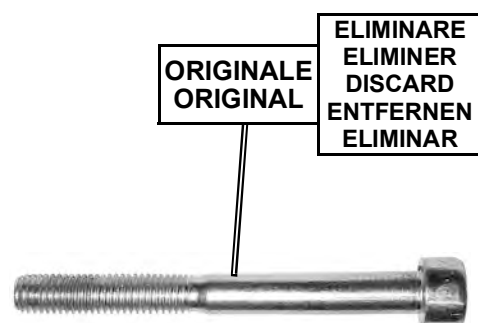

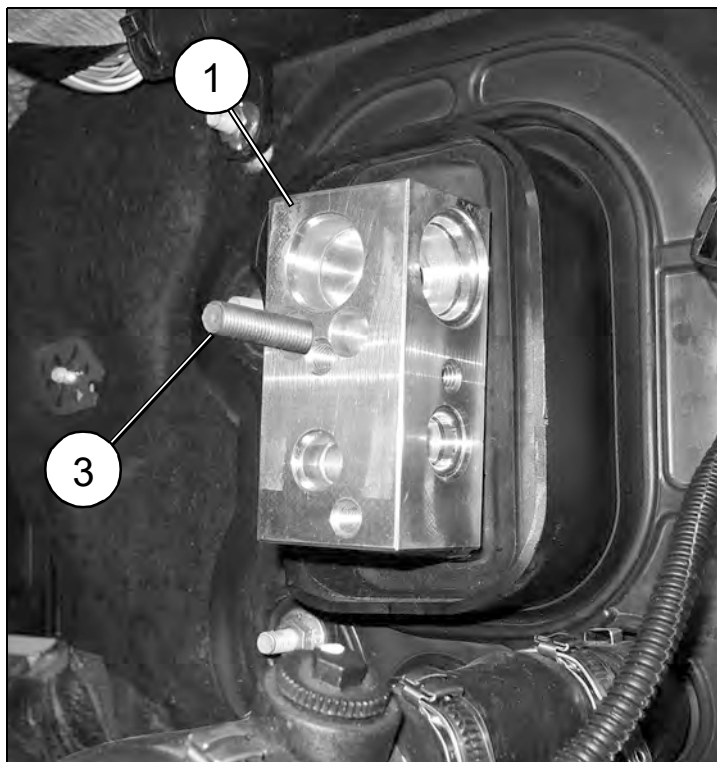

7A

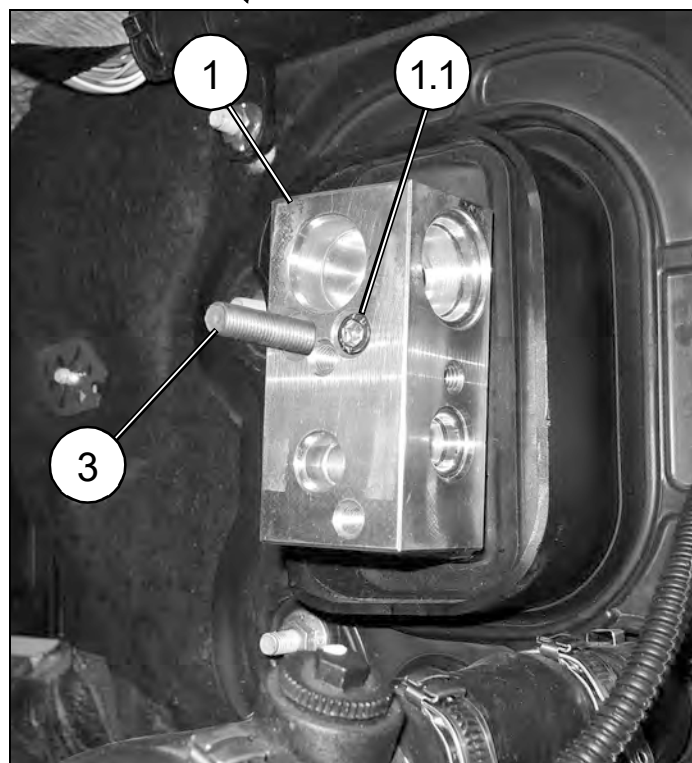

**ELEMENTI DI FISSAGGIO / PIÈCES DE FIXATION / FIXING PARTS
BEFESTIGUNGSELEMENTE / ELEMENTOS DE FIJACION**

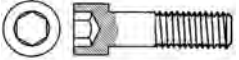
Pos.	Tipologia / Typologie Typology / Tipologie Tipologia	Descrizione / Description Description / Beschreibung Descripción
1.1		M5 x 65

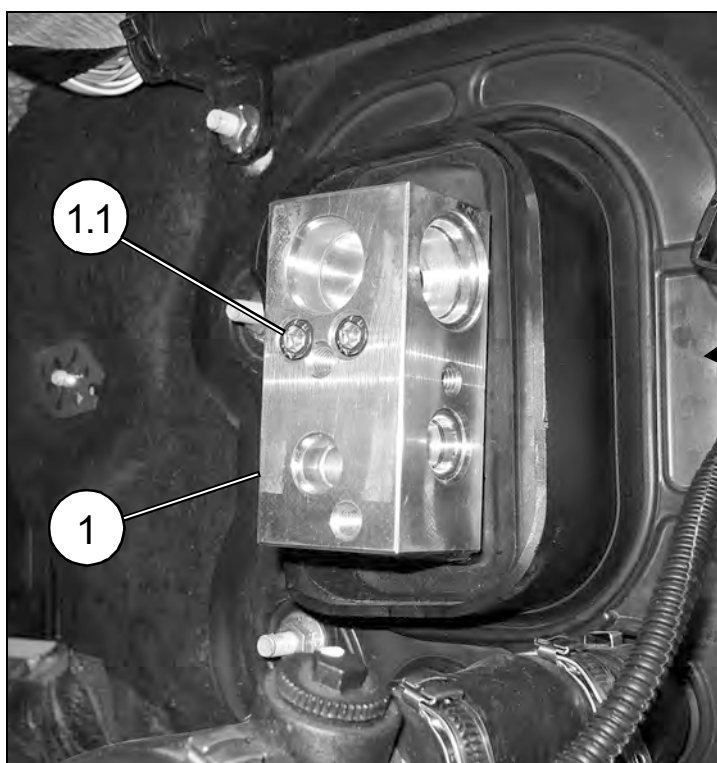

RIMUOVERE
ENLEVER
REMOVE
ENTFERNEN
QUITAR







8A

ORIGINALI ORIGINALS	RIMONTARE REPOSER REASSEMBLE WIEDER EINBAUEN VOLVER A MONTAR
------------------------	--------------------------------------------------------------------------

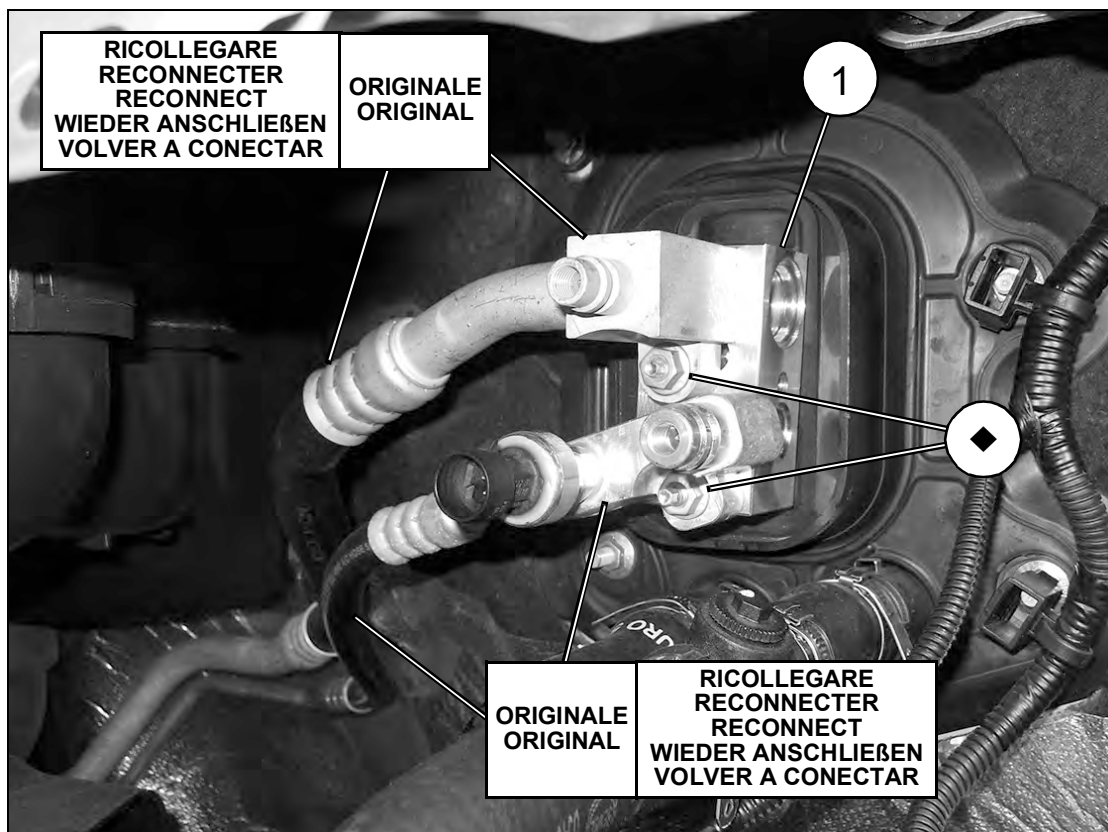
9A



ELEMENTI DI FISSAGGIO / PIÈCES DE FIXATION / FIXING PARTS BEFESTIGUNGSELEMENTE / ELEMENTOS DE FIJACION		
Pos.	Tipologia / Typologie / Typology Tipologie / Tipologia	Descrizione / Description / Description Beschreibung / Descripción
◆		ORIGINALI / ORIGINAL

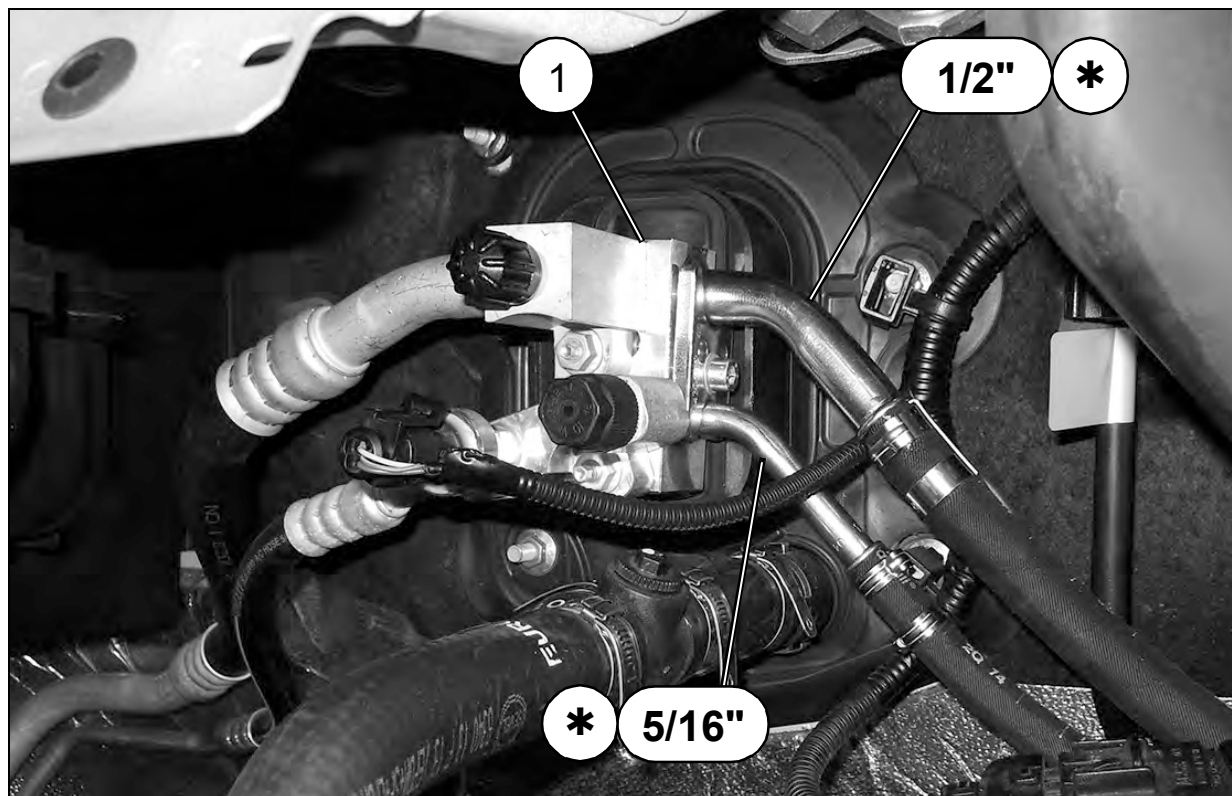

10A

- (I) * Esempio di installazione blocchetto a 3 vie e collegamento tubi gas per 2° evaporatore mediante l'utilizzo di raccordi d'acquisto a cura dell'installatore.
- (F) * Exemple d'installation d'adaptateurs et connexions aux tuyaux de gaz pour un 2° évaporateur en utilisant les raccords que l'installateur devra acheter.
- (GB) * Example of installation of the adapter and connection of the gas hoses for the 2nd evaporator through the use of connections purchased by the installer.
- (D) * Einbaubeispiel der Anpasstücke und Verbindung für 2 Verdampfer an die Kältemittelschläuche mittels Verbindungsstücke, die vom Einbauer zu kaufen sind.
- (E) * Ejemplo de instalación de adaptadores y conexión tubos de gas para 2° evaporador mediante la utilización de rácores comprados por cuenta del instalador.

Il numero di telefono relativo al paese specifico è indicato sull'opuscolo del centro servizi Webasto ed è disponibile sul sito web della propria filiale Webasto.

Pour trouver le numéro de téléphone du pays concerné, veuillez consulter le dépliant des points-service Webasto ou la page web de la représentation Webasto de votre pays.

The telephone number of each country can be found in the Webasto service center leaflet or the website of the respective Webasto representative of your country.

Die Telefonnummer des jeweiligen Landes entnehmen Sie bitte dem Webasto Servicestellenfaltblatt oder der Webseite Ihrer jeweiligen Webasto Landesvertretung.

Consulte el número de teléfono del país correspondiente en el folleto de los servicios autorizados Webasto, o en la página web de su representante Webasto.

Webasto Thermo & Comfort SE
Postfach 1410
82199 Gilching
Deutschland

Besucheradresse:
Friedrichshafener Str. 9
82205 Gilching
Deutschland

Technical Extranet: <http://dealers.webasto.com>

Nur innerhalb von Deutschland
Tel.: 0395 5592 444
E-mail: technikcenter@webasto.com

www.webasto.com