

1

SEA00041LA
SERVICE THERMOSTAT
TERMOSTATO DI SERVIZIO



6

SFD00031AA
LK 514 SAFETY VALVE 5.0 Kp/cm
VALVOLA DI SICUREZZA LK514 5BAR



10

SGB00049AA
FIXING BRACKET KIT SLIM 15/20/25 L.
KIT FLANGIA FISSAGGIO SLIM 15/20/25L.

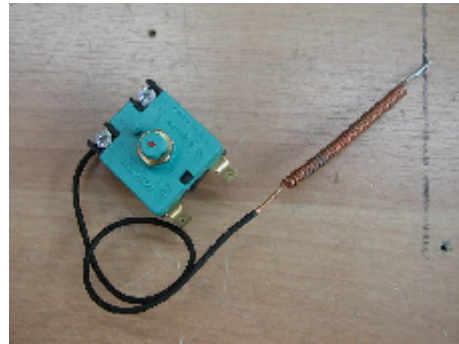

2

SEA00042LA
SAFETY THERMOSTAT
TERMOSTATO DI SICUREZZA



7

SFD00011AA
MIXING VALVE LK550
VALVOLA MISCELATRICE LK550

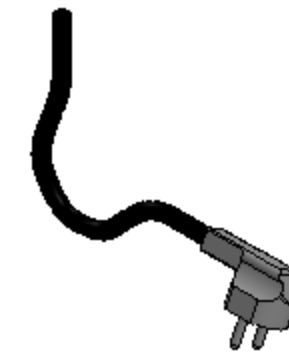

11

SGB00096AA
POWER CABLE WITH EU PLUG
CAVO ALIMENTAZIONE CON SPINA EU
SGB00073AA
POWER CABLE WITH UK PLUG
CAVO ALIMENTAZIONE CON SPINA UK
SGB00080AA
POWER CABLE WITH USA PLUG
CAVO ALIMENTAZIONE CON SPINA USA

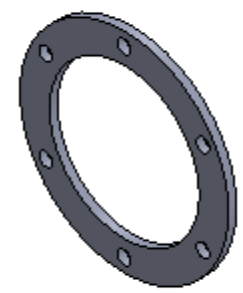

3

SDF00033AA
RUBBER GASKET FLANGE SQUARE 16L
GUARNIZIONE STAFFA SQUARE 16L



8

SBE00073AA
PLASTIC COVER SLIM SQUARE 16L TUBE SIDE
COPERTURA SLIM SQUARE 16L LATO TUBI

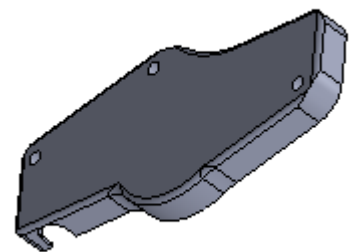

4

SBE00075AA
GREY PLASTIC COVER SQUARE 16L
COPERTURA PLASTICA GRIGIA SQUARE

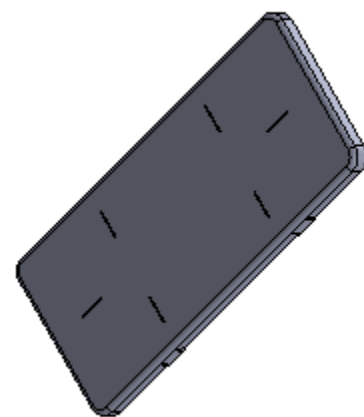

9

SBE00073AB
PLASTIC COVER SLIM SQUARE 16L BACK SIDE
COPERTURA SLIM SQUARE 16L RETRO

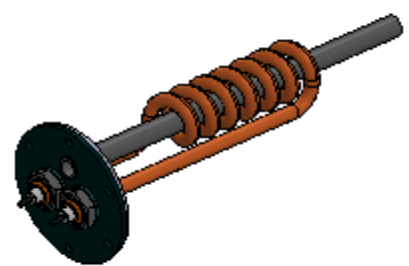

5

SEE00028LA
HEATING ELEMENT SLIM SQUARE 16L 230V/750W
RESISTENZA SLIM SQUARE 16L 230V/750W
SEE00029HA
HEATING ELEMENT SLIM SQUARE 16L 115V/750W
RESISTENZA SLIM SQUARE 16L 115V/750W

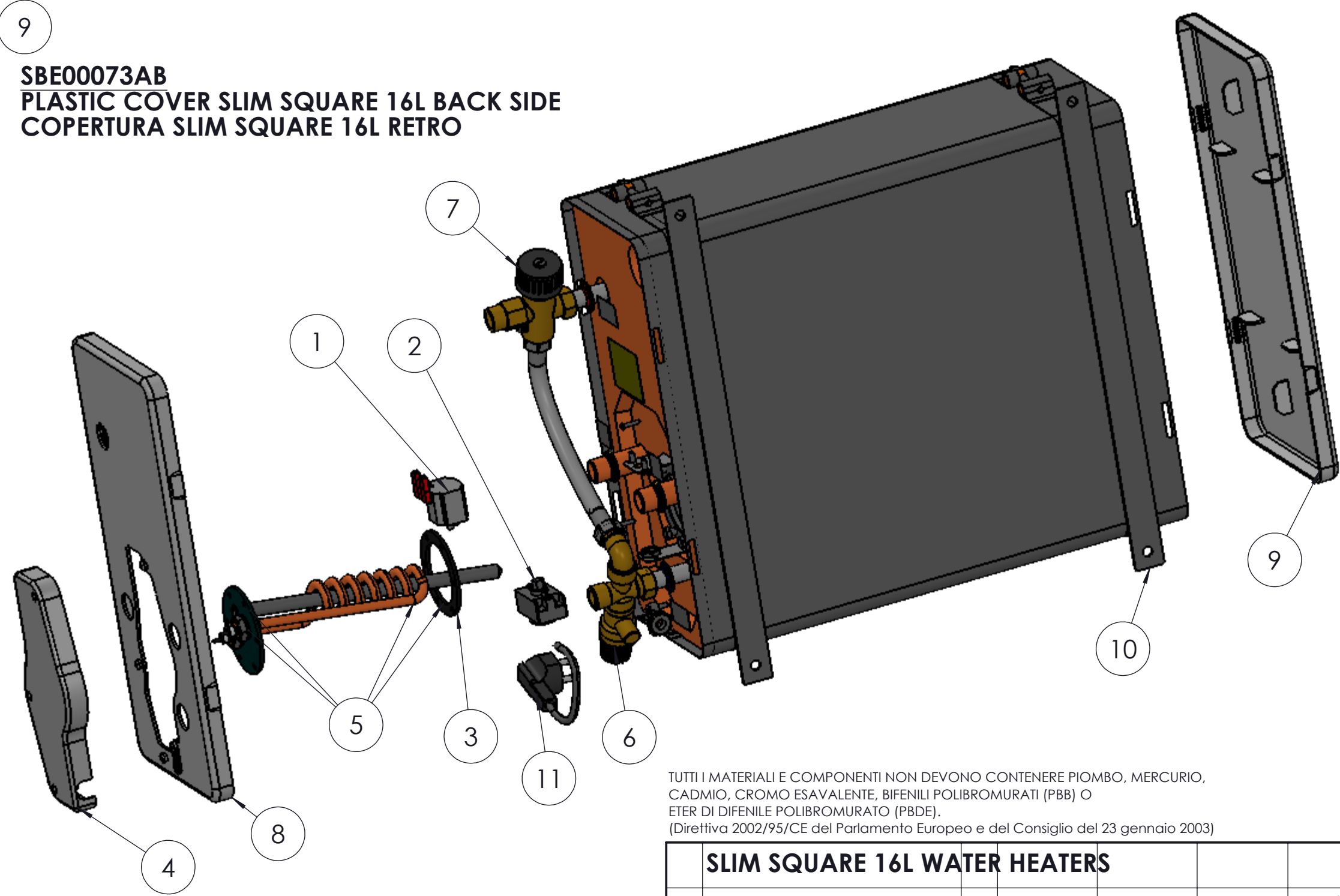

TUTTI I MATERIALI E COMPONENTI NON DEVONO CONTENERE PIOMBO, MERCURIO, CADMIO, CROMO ESAVALENTE, BIFENILI POLIBROMURATI (PBB) O ETER DI DIFENILE POLIBROMURATO (PBDE).
(Direttiva 2002/95/CE del Parlamento Europeo e del Consiglio del 23 gennaio 2003)

SLIM SQUARE 16L WATER HEATERS						
Pos.	DENOMINAZIONE	Q	Materiale	Stato/Unific.	Peso	Codice
Tolleranze generali		Caratteristiche speciali da P-PRO		Disegnato	Data	Scala
ISO 2768 - m		⊖ CRITICA ⊕ IMPORTANTE				1:10
				Via dei Ronchi, 11 - 47866 Sant'Agata Feltria (RN) Tel. +39 0541 848 030 - Fax +39 0541 848 563		
Disegno eseguito con CAD vietata la modifica manuale				CODICE		
A termini di legge ci riserviamo la proprietà di questo disegno con divieto di riproduzione senza la nostra autorizzazione						

N° Data Dis. E.C. MODIFICHE