

BlazeCut Automatic Fire Suppression System

System Manual

Specification, Installation and Operation

C Series Indirect Low Pressure Powder Systems

CPO200

CPO210



TABLE OF CONTENTS

1	INTRODUCTION	5
2	BASIC INFORMATION ABOUT THE SYSTEM	6
2.1	EXPLANATION OF MODEL NAME CAPTION	6
2.2	TECHNICAL SPECIFICATION AND TYPES.....	8
2.3	USE OF THE SYSTEM	8
3	SYSTEM DESIGN LIMITATIONS	10
3.1	GENERAL RULES FOR DESIGN	10
3.2	TOTAL FLOODING APPLICATIONS.....	12
3.3	LOCAL APPLICATIONS.....	15
4	COMPONENTS OF THE SYSTEM AND THEIR DESCRIPTION	17
4.1	CYLINDERS FOR EXTINGUISHING AGENT.....	17
4.2	CYLINDER VALVES	19
4.3	PRESSURE GAUGE	28
4.4	BLAZETUBE DETECTION	29
4.5	BLAZETUBE PUSH-IN CONNECTORS	30
4.6	BLAZETUBE END-OF-LINE DEVICES.....	31
4.7	BLAZEWIRE.....	32
4.8	FASTENING MATERIAL	37
4.9	LABELS.....	39
5	DEFINITION OF LEGAL REQUIREMENTS	42
6	INFORMATION ON EXTINGUISHING AGENT USED	42
6.1	DESCRIPTION	42
6.2	PERMISSIBLE USES OF THE EXTINGUISHING AGENT.....	42
6.3	IMPROPER USES OF EXTINGUISHING AGENT	43
6.4	WARNINGS.....	43
7	INSTRUCTIONS FOR INSTALLATION OF THE SYSTEM	43
7.1	INSTALLATION AND PLACEMENT OF THE CYLINDER	43
7.2	MULTIPLE CYLINDERS CONNECTION.....	47
7.3	INSTALLATION OF DISTRIBUTION NETWORK	50
7.4	INSTALLATION OF THE BLAZETUBE DETECTION	63
7.5	PRESSURISATION OF THE CYLINDER AND THE DETECTION SYSTEM.....	69
7.6	FINAL INSPECTION OF THE SYSTEM INSTALLATION.....	75
8	REGULAR INSPECTION AND MAINTENANCE OF THE FIRE SUPPRESSION SYSTEM	75
8.1	FINAL INSPECTION OF THE SYSTEM INSTALLATION.....	77

8.2	INSPECTION OF THE SYSTEM INSTALLATION.....	77
8.3	PRESSURISATION OF THE SYSTEM.....	78
8.4	REMOVAL OF THE SYSTEM FROM SERVICE	84
9	OPERATION OF BLAZECUT SYSTEM IN CASE OF FIRE	85
10	RESTORATION OF ACTIVITY OF BLAZECUT SYSTEM IN CASE OF FIRE	88
11	SYSTEM DEACTIVATION	89
12	MAINTENANCE OF THE SYSTEM, REPLACEMENT OF COMPONENTS	89
12.1	GENERAL RULES	89
12.2	REPLACEMENT OF THE CYLINDER	89
12.3	REPLACEMENT OF THE BLAZETUBE DETECTION	90
12.4	RELEASE OF THE PISTON OF THE VALVE IN CASE OF ACCIDENTAL OPENING.....	91
12.5	CLEANING AFTER SYSTEM ACTIVATION	91
12.6	CLEANING THE SYSTEM.....	92
12.7	DECLARATION OF CONFORMITY	92
13	LIST OF ANNEXES.....	92
ANNEX 1: DETECTION, SIGNALING AND ACTIVATION DEVICES.....		93
A1.1.	DETECTORS	93
A1.2.	SIGNALLING UNITS.....	94
A1.3.	ALARM PANELS	95
A1.4.	ELECTRIC ACTUATORS.....	98
ANNEX 2: PRESSURE MONITORING.....		99
A2.1.	PRESSURE TRANSDUCER ATA100.....	99
A2.2.	PRESSURE SWITCH APS001-xx.....	99
A2.3.	PRESSURE SWITCH APS003-xx.....	100
A2.4.	INSTALLATION OF THE PRESSURE MONITORING COMPONENTS	101
A2.5.	ELECTRICAL CABLES AND CONDUITS.....	103
ANNEX 3: PNEUMATIC REMOTE ACTUATORS ARA010 AND ARA020.....		105
A3.1.	BASIC INFORMATION ABOUT THE COMPONENTS	105
A3.2.	INSTALLATION OF THE REMOTE ACTUATOR	108
A3.3.	ACTIVATION OF THE REMOTE ACTUATOR.....	114
A3.4.	PRESSURISATION OF THE LOP LINE	114
ANNEX 4: ELECTRIC REMOTE ACTUATORS ARA110 AND ARA120.....		118
A4.1.	BASIC INFORMATION ABOUT THE COMPONENTS	118
A4.2.	INSTALLATION OF THE REMOTE ACTUATOR	119
A4.3.	ACTIVATION OF THE REMOTE ACTUATOR.....	123

AUTOMATIC FIRE SUPPRESSION SYSTEMS



ADDITIONAL NOTES..... 124

1 INTRODUCTION

1.1.1 MANUFACTURER INFORMATION

BlazeCut s.r.o., Triblavinská 3191, 90025 Chorvátsky Grob, Slovakia

GLOBAL HEAD OFFICE

BlazeCut Pty Ltd., Level 24, Three International Towers, 300 Barangaroo Avenue, Sydney, NSW 2000, Australia
+61 2 8006 1300

www.blazecut.com; customerservice@blazecutgroup.com

1.1.2 INSTRUCTIONS FOR USE OF THE MANUAL

This manual is intended to supply technical information for trained and authorized personnel by BlazeCut Group. Any personnel performing installation, inspection, maintenance or replacement of components with the BlazeCut system shall have this manual available and proceed solely in accordance with it. Failure to follow the instructions in this manual and any other BlazeCut manuals may result in system malfunctioning, causing damage to the protected equipment and presents serious danger to the life and health of others.

1.1.3 SAFETY FIRST

Please read this manual in its entirety. Operation and installation instructions need to be fully understood before this BlazeCut product is installed. Failure to do so may void warranty. Your local governing regulations for safety and compliance must be followed.

1.1.4 WARNINGS AND CAUTIONS



This symbol within the manual represents warning of specific risks, dangers, or warning of described procedures. Failure to follow the instructions in the text marked with this symbol may result in loss of warranty, damage to property, threat to safety or life of persons performing the operation on the system or persons in the vicinity. Do not proceed without following the instructions marked with such symbols.

1.1.5 FURTHER INFORMATION

BlazeCut® is a registered trademark of BlazeCut and is recorded in the Register of Community Trade Marks.

If any of the instructions in this manual are unclear or in case of further questions, contact the BlazeCut Team.

This document is the property of BlazeCut It is prohibited to reproduce it, copy it in whole or in part, or provide third parties with any related information without prior written consent of BlazeCut.



WARNING

Please ensure that the safety instructions are fully understood before the equipment is put into service.

Do not modify any part of the BlazeCut components as this may cause serious injury or a failure of the system.

Always wear the appropriate protective equipment and clothing whilst installing or servicing.

2 BASIC INFORMATION ABOUT THE SYSTEM

2.1 EXPLANATION OF MODEL NAME CAPTION

C PO 211-01-4-2-H-M

Product line

C – Cylinder Series systems

Extinguishing agent

PO – ABC powder agent

Valve series

- 201 – pneumatic with BlazeTube push-in connector straight
- 202 – pneumatic with BlazeTube push-in connector 90° elbow
- 203 – pneumatic with BlazeTube push-in connector Tee
- 207 – pneumatic with plugged top port
- 211 – electric valve with 12 V solenoid
- 212 – electric valve with 24 V solenoid

Top G1/8" port left and right on the valve

- 0 – plug
- 1 – ball valve with BlazeTube push-in connector
- 2 – ball valve with LOP hose fitting
- 3 – M10x1 adapter with a plug

Quantity of extinguishing agent

- 4 – 4.0 kg of agent
- 6 – 6.0 kg of agent
- 12 – 12 kg of agent etc.

Quantity of nozzles

- 2 – 2 discharge nozzles
- 4 – 4 discharge nozzles
- 6 – 6 discharge nozzles etc.

Type of hose/tube

- B – braided hose
- G – galvanised tube
- H – red fire hose
- S – stainless steel tube
- GB – galvanised tube and braided hose
- GH – galvanised tube and hose
- SB – stainless steel tube and braided hose
- SH – stainless steel tube and hose

Application variant

- C – customised kit
- M – mobile application
- MC – mobile application customised

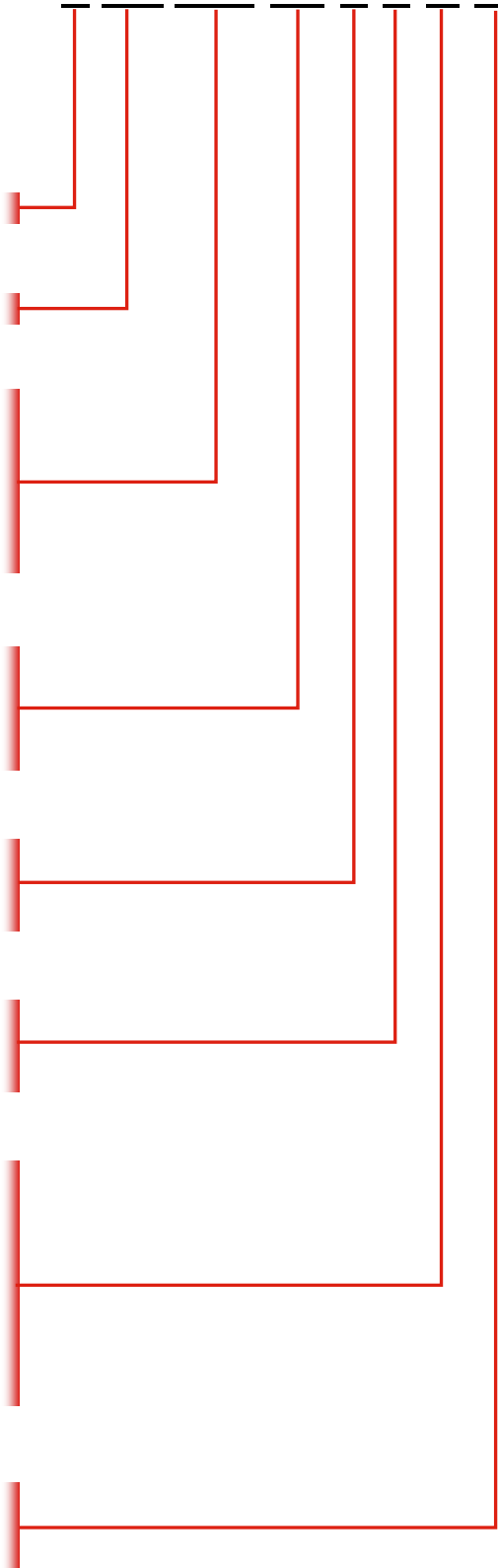



Example 1: CPO202-02-6-4-G-M – includes BlazeCut system with one cylinder (C) with the extinguishing agent used ABC powder (PO), with the valve type 202 (202), plug on the left and hose fitting on the right (-02), total amount of extinguishing agent 6 kg (-6), 4 nozzles (-4), galvanised tube (-G), mobile application (-M).

Example 2: CPO211-31/203-00/202-00-18-12-G-M – includes BlazeCut system with three cylinders (C) with the extinguishing agent used ABC powder (PO), with the valve type 211 (211) with a M10 adapter on the left and a BlazeTube push-in connector on the right (-31), valve 203 with plug on the left and plug on the right (/203-00) and valve 202 with plug on the left and plug on the right (/202-00), total amount of extinguishing agent 3x6 kg (-18), 3x4 nozzles (-12), galvanised tube (-G), mobile application (-M).

2.1.1 ASSOCIATED NAMES

In certain parts of this manual, it is needed to state use of multiple valves or cylinders. In these cases, associated naming is used.

Table 1: Naming explanation

Designation	Meaning
valves 20x	all the following: 201, 202, 203, 207
valves 21x	all the following: 211, 212
systems CPO (20x, 21x)	all the following: CPO201, CPO202, CPO203, CPO207, CPO211 and CPO212

2.1.2 DESCRIPTION OF THE SYSTEM

Commercial name: BlazeCut

Characteristics: Powder Automatic Fire Suppression System

Type: Cylinder Series (C Series), Indirect Low Pressure (ILP)

Functionality: BlazeCut C series systems are designed to protect closed, semi closed and open (fixed) spaces. Some examples are engine compartments of trucks, buses, and other vehicles and machines and other spaces with increased risk of fire where powder fire extinguishing agent can be used.

Both the pneumatic and electric systems are referred to as indirect low pressure or ILP systems for short. The system can be activated by pneumatic detection or electric detection and the agent is distributed via discharge lines using distribution hoses/tubes, fittings and nozzles.

The pneumatic fire suppression system operates by detecting fire using a BlazeTube detection connected to the cylinder valve. The BlazeTube detection is placed in the protected enclosure and is under constant pressure whereby keeping the valve piston closed. When a fire occurs, the BlazeTube detection degrades by the effect of fire or high temperature and ruptures, releasing the pressure in the detection circuit. This causes the cylinder valve's piston to open, allowing the extinguishing agent in the cylinder to be released via the discharge outlet(s) on the valve. The agent is dispersed to the protected enclosure through a network of hoses and nozzles. The detection system is independent of any electrical supply and operates solely on physical principles and is fully automatic.

Alternatively, the electric system can detect the fire using electric devices such as a Linear Heat Detection (LHD) BlazeWire, smoke/heat detectors, heat probes or others. These electric devices must be used in conjunction with the integrated solenoid valves – types 211 (12 V), 212 (24 V).

The BlazeCut systems CPO21x have an integrated solenoid valve, which allows the activation of a system by receiving a signal from an external detection or actuation device. These can include an alarm panel, fire panel, detector, remote manual actuators etc.

2.1.3 OPTIONAL COMPONENTS

The BlazeCut ILP systems can have optional components added to the system which increase the features of the system. Installation, use, function and service of selected optional components is described in annexes of the Installation and service manual or supplied as a separate manual. For more information contact the supplier.

2.2 TECHNICAL SPECIFICATION AND TYPES

Table 2: Types of BlazeCut ILP powder systems

Model number	Pre-installed BlazeTube outlets	Pneumatic Activation	Electrical activation (Solenoid)	Operation pressure at 20 °C [bar]	Operation temperature [°C]
CPO201	Yes	Yes	-	25	-30 to +60
CPO202	Yes	Yes	-		
CPO203	Yes	Yes	-		
CPO207	Yes	Yes	-		
CPO211	optional	optional	Yes		
CPO212	optional	optional	Yes		

NOTE

Operation temperature refers to temperature in the protected enclosure as well as pressure cylinder location.

Table 3: Installation characteristics for BlazeCut ILP powder systems

Description	Value
Test pressure of the pressure equipment	30 bar
Amount of agent	2.4 to 12 kg
Type of extinguishing agent	ABC Powder
Expellant gas	nitrogen
Connection to a fire alarm or other warning device	with AAP210, AAP211
Display, monitor and provide a low-pressure alarm	with APS001/ATA100 + AAP210/AAP211; APS001 + custom panel
Connection to a sounder or other alarm activation system	with APS001 + signalling unit
Isolating power supplies and shutting down equipment upon system activation	with APS001, AAP210 or AAP211

2.3 USE OF THE SYSTEM

The BlazeCut system is designed for protection of areas from fire, using local fire suppression with powder extinguishing agent.

The fire suppressing performance depends on many factors, including the size of the protected enclosure, the type of the flammable substances, the shape and venting of the enclosure, the restriction on placement of extinguishing nozzles, air circulation etc. In order to reach the desired extinguishing concentrations, effectiveness of the system, the choice on the type and amount of agent and what installation method to use please discuss with the supplier of the system.

In order to achieve accurate design of the system it is necessary to obtain the following information:

- the dimensions of the protected area,
- openness of the protected area and airflow in it,
- the nature of fire risk in the protected area (presence of flammable materials, their amount, location),
- layout of the protected enclosure,
- risks with the highest probability of fire (presence of possible ignition sources of fire),
- placement options of the system within the protected area (especially the location of the cylinder, distribution tubes/hoses, nozzles and detection devices),
- the presence of people in the protected area, and what safety measures are required to limit human exposure to agents,
- the method of operation of the protected equipment, etc.

It is always recommended to discuss the potential fire risk factors in the protected enclosure with a local fire protection specialist who has knowledge about the protected enclosure and this information is provided to the supplier of the system. A BlazeCut risk assessment template is available for this purpose if required.

It is also necessary that the conditions in the protected area are in accordance with the permissible parameters of the system, especially the lowest and highest temperature in the protected area.

Remember that there are many factors and variables that can affect the extinguishing process in event of fire. It is not possible to guarantee total suppression of fire in the protected enclosure under all circumstances.

The BlazeCut system is designed to protect equipment in closed spaces. Use in partially or completely open spaces or spaces with strong air circulation may significantly decrease the efficiency of the system.

In case of forced ventilation in the protected enclosure, after activation of the system the ventilation shall be switched-off immediately to avoid venting of the agent from the protected area. In such case, it is recommended to provide automatic cut-off of the ventilation when BlazeCut system is activated (e.g., with the Pressure Switch APS001-xx or APS003-xx).

Use of the system is also limited by the properties of extinguishing agent used and its possible application. Detailed information is described in Chapter [6.2](#).

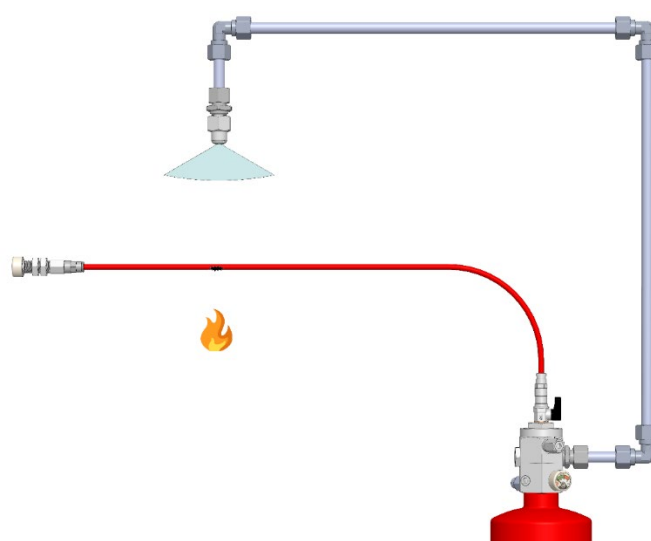

Principle of operation of BlazeCut ILP powder system with BlazeTube detection

2.3.1 ELECTRIC SYSTEMS – CPO(211,212)

The system does not use BlazeTube for automatic activation and can be designed to suit each application by having different activation behaviours. Available options are a manual only, a fully automatic or a combination of both.

The manual only option, could be used to reduce the risk of human exposure to the agents and give the persons in charge an opportunity to assess the surroundings before activating a system. Electrical detection can be used for sounding an alarm if required. Activating manually can be instigated by using an electric signal sent from an alarm panel or an electric actuation device.

The automatic option can be achieved by using LHD BlazeWire or an electrical detection device without any delay programmed. This will deliver an instant actuation upon detection of the fire or there is an option to delay discharge that can be achieved with programming an alarm panel output to the solenoid on the cylinder valve.

The automatic/manual option usually consists of a combination of an electric actuation device and an electrical detection device. If a fire is noticed before it is detected, a manual activation device can be used to achieve a quicker discharge.

The valves 211-30 and 212-30 with the integrated solenoid are supplied in BlazeCut kits with a M10x1 adapter on one of the detection ports to assist with a piston reset or a system refill. Different configurations are available on request.



Never untighten a plug or fitting that closes the detection ports on the cylinder valve. If removed, this can cause the immediate opening of the cylinder valve piston and will release the extinguishing agent.

With electric detection it is still possible to install a pneumatic remote actuator ARA010 or ARA020 directly to the cylinder valves 211 and 212. This can be done by changing the detection port options on the valves before the cylinder has been filled and pressurised.

2.3.2 BLAZETUBE USED OUTSIDE THE PROTECTED ENCLOSURE

In some non-harsh environments, use of the BlazeTube can be useful to connect two or more cylinder valves together or to supply a detection circuit directly to a pneumatic remote actuator ARA010 or ARA020 from a cylinder valve.

In harsh environments or high vibration installations the detection outlet on the valve and remote actuators can be fitted with a pneumatic hose fitting. A pneumatic hose then can be used for connecting the detection circuit between cylinder valves and remote actuators. The pneumatic hose has a higher durability against mechanical damage and direct weather exposure compared to the BlazeTube.

2.3.3 WARNINGS



The BlazeCut system is a suppression system only and is not designed or intended to extinguish all fires. Where there are high airflows and a high accumulation of combustible materials, this will dramatically alter the systems performance. Always consider supplementary firefighting equipment be available in case the system does not totally extinguish a fire. For more information about the use of the system in an area occupied by persons, please contact your supplier.



The use of the system in vehicles must be done with additional considerations of air flow and powder concentrations. In vehicles with high ventilation or airflow the suppression ability will be impaired.



Install and use the BlazeCut C Series with originally supplied components. Do not replace anything in the system. The use of external components not approved by the manufacturer, for example beacons and alarms, will not be the responsibility of BlazeCut and no warranty or claim will be acknowledged in this regard.



Each BlazeCut system cylinder is designed as an independently operating unit (also in case of a multiple cylinder connection). It is not possible to connect several independent systems into one discharging unit. Each cylinder must have separate feedlines.



BlazeCut system is not compatible with other fire suppression systems, do not try to connect the system to any other equipment.



The system may be installed, maintained and repaired only by persons trained or authorized by the manufacturer and should have relevant professional qualifications depending on the procedure. Incorrect interference with the system may cause malfunction of the system and may threaten the safety and health of people.



The system is not designed to be used as portable fire extinguisher. Do not try to suppress fire by holding the system in hands or sprinkling the extinguishing agent directly into the fire. Do not use the system in any other way than described in this manual.

3 SYSTEM DESIGN LIMITATIONS

3.1 GENERAL RULES FOR DESIGN

The BlazeCut pre-engineered systems minimise the amount of engineering required in the application design. No hydraulic calculations are required to determine pressure drop, agent flow, or discharge time. The feed lines and nozzles need to be installed within the limitations in this manual.



The BlazeCut fire system is a pre-engineered fire suppression system and must not be designed outside any limits mentioned in this manual. If unsure of what application type and application rates are required, please contact a BlazeCut representative.

All application rates for the BlazeCut powdered systems in total flooding and local applications meet the recommendations in NFPA 17.

BlazeCut systems do not cover fully open outdoor applications due to the systems being run at low pressures.

Table 4: Powder system limitations

Type	Standard application	
Operation pressure at 20 °C	25 bar	
Maximum operating pressure at T_{max}	29 bar	
Operation temperature of the system	-30 °C to +60 °C	
Maximum vertical distance between the cylinder valve and distribution hose/tube	2 m (200 cm)	
Maximum total length of distribution network per one cylinder (including fittings)	700 cm/1 outlet (2 and 4 kg systems) 800 cm/2 outlets (2 and 4 kg systems) 1000 cm/1 outlet (6 kg system) 2000 cm/2 outlets (6, 10 and 12 kg systems)	
Number of nozzles per one cylinder	1 (2 kg system) 2 (2, 4 and 6 kg systems) 3 (4 and 6 kg systems) 4 (6, 10 and 12 kg systems) 6 (10 and 12 kg systems)	
Number of nozzles per discharge outlet	1 (2 kg system) 2 (2, 4, 6, 10, 12 kg systems) 3 (10 and 12 kg systems)	
Number of outlets used	1 (2, 4 and 6 kg systems) 2 (6, 10 and 12 kg systems)	
Maximum number of cylinders connected in series	6	
Maximum length of BlazeTube with one cylinder	40 m for one cylinder	
Maximum total amount of fittings per discharge outlet	2 kg system: elbows = 3, Tees = 1 4 kg system: elbows = 3, Tees = 1 6 kg system: elbows = 3, Tees = 2 10 kg system: elbows = 3, Tees = 2 12 kg system: elbows = 3, Tees = 2	
Maximum coverage	See Chapter 3.2 and 3.3	

The maximum of three nozzles on one discharge line is to ensure an equal dispersant of powdered agent between each nozzle.

All parts of the system must be placed into the protected enclosure so that they are not in direct contact with parts of the protected equipment or in the immediate vicinity of the equipment parts that reach high temperatures during operation (transformers, engine block, exhaust pipes, etc.), not exposed to aggressive chemical substances (caustic, acids, solvents, corrosive substances etc.) and it is not exposed to direct atmospheric influences.

All components of the BlazeCut system must be firmly secured by using the recommended fixings to avoid movement and vibration. Do not secure any components to parts, which may move when the protected equipment is in operation.

Choose mountings so that fastening components are not damaged when the device is in operation. Accidental displacement of any part of BlazeCut system from the place of installation may result in reduction of the extinguishing effect of the system, its damage or device damage.

The system has to be positioned so that it is possible to perform future maintenance, component replacement, inspections and optimising safety of the pressurised equipment. Do not secure any components that will interfere with future inspection and maintenance of the equipment.

Ensure that no part is damaged after closing off the protected enclosure (e.g., after closing the covers/doors of the installation, engine etc.) and that no part is affected by moving parts of the equipment (fans etc.).

When fastening the system, make sure not to damage other parts of the equipment.

Do not overload the threads on the components, do not tighten or release the threads on the components forcibly, use the correct tightening torque. Make sure not to damage the components of the system by tools. Always check that the thread is clean and undamaged before installation.

In the event of subsequent changes in the protected enclosure during operation of BlazeCut system, always check whether changes are or not necessary in the installation of the system, relocation of networks, nozzles etc. to secure the functionality and efficiency of the system.

3.1.1 WARNINGS



Installation of the system, its activation and repair and maintenance is governed by specific legislation and these activities may only be performed by persons with relevant professional qualification subject to applicable legislation.



After the installation of the system the configuration is under constant pressure. Never tamper with the system under pressure.



In the case of work in the vicinity of electrical equipment observe corresponding safety rules and instructions. Do not perform installation and maintenance of the system when the equipment is in operation. In the case of work in the vicinity of electrical equipment observe corresponding safety rules and instructions. Work on electrical installations may be performed only by qualified persons.



Install and use BlazeCut system only with original supplied components. Do not replace anything in the system; use only original component and spare components. Using components not approved by the manufacturer causes loss of warranty, may cause malfunction of the system and presents danger to life and health of persons.



Do not install the cylinder to configuration if non-corresponding pressure is detected in the cylinder during inspection.



The system may be installed, maintained and repaired only by persons trained or authorized by the manufacturer and depending on procedure also with relevant professional qualification. Unprofessional interference with the system may cause malfunction of the system and provides danger to safety and health of people.



When handling parts of the system under pressure (cylinder, valves, pressure switch, BlazeTube detection) always wear appropriate protective glasses with side-shields. Eyes may be seriously damaged when coming into contact with extinguishing agent in case of sudden leak.

3.2 TOTAL FLOODING APPLICATIONS

A total flooding application is defined by a closed area with maximum openings not exceeding 1 % of the total area of all four sides, top, and bottom of the enclosure. In the event that the openings are greater than 1 % allowances of addition powder for openings will be calculated based on the size of the opening. This is based on the NFPA 17 requirements for total flooding systems.

The calculation is based on

- net volume equals to total volume minus volume of permanent solid objects;
- powder calculation of 0.50 kg per 1 m³ of the nett volume;
- 1 nozzle per 4 m² based on the width and length of the floor surface;

- additional powder to be added for openings between 1 % and 5% calculated at 2.44 kg/m² based on the m² size of the opening;
- additional powder to be added for openings between 5 % and 15 % calculated at 4.88 kg/m² based on the m² size of the opening;
- for enclosures with permanent openings exceeding 15 %, follow Chapter 3.3 for local application.

Only the ANP120 nozzle can be used in total flooding applications with the nozzles always being inside top of the enclosure and must always be oriented downwards.

Table 5: Coverage limitations for flooding applications with less than 1 % openings at maximum nozzle height

Cylinder volume [L]	Total agent [kg]	Discharge ports used	Nozzles per discharge port	Total nozzles and type	Max. Nozzle height from the floor [m]	System volume coverage [m ³]
2.4	2	1	1	1 x ANP120	2.0	4
		1	2	2 x ANP120		
5.0	4	1	2	2 x ANP120	2.5	8
		1	3	3 x ANP120		
7.8	6	1	2	2 x ANP120	2.5	12
		2	2	4 x ANP120		
13.0	10	2	2	4 x ANP120	2.5	20
		2	3	6 x ANP120		
16.0	12	2	2	4 x ANP120	2.5	24
		2	3	6 x ANP120		

NOTE

When using configurations with 6 nozzles, the agent distributed to each nozzle will depend on the distribution network configuration. See Chapter 7.3 for more information.

3.2.1 DESIGN NOTES

The volume calculated is a nett volume with deductions included for permanent objects.

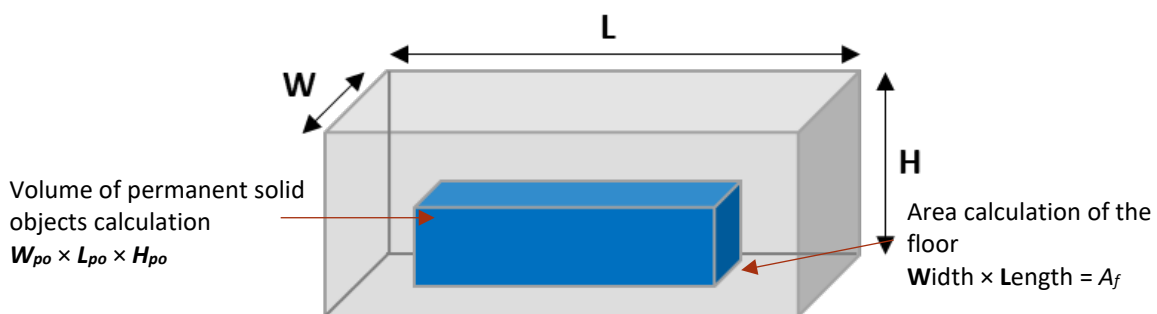

Simplified model of the enclosed space with one permanent solid object

$$V = W \times L \times H \text{ [m}^3\text{]} \quad (1)$$

V – total volume of the enclosed space [m³]

W – width [m]

L – length [m]

H – height [m]

$$V_{po} = W_{po} \times L_{po} \times H_{po} \text{ [m}^3\text{]} * \quad (2)$$

V_{po} – volume of one permanent solid object [m³]

W_{po} – width of one permanent solid object [m]

L_{po} – length of one permanent solid object [m]

H_{po} – height of one permanent solid object [m]

*if more than one permanent solid object is present, calculate the volume V_{po} for all of them

$$V_t = V - V_{po} \text{ [m}^3\text{]} \quad (3)$$

V_t – compartment volume excluding all permanent objects [m³]

$$A_t = 2(W \times L) + 2(W \times H) + 2(H \times L) \quad (4)$$

A_t – total area of all four sides, top and bottom of the enclosure [m²]

$$E_{add} = A_v \times E_v \text{ [kg]} \quad (5)$$

E_{add} – additional amount of extinguishing agent compensating for size of all vents (openings) [kg]

A_v – area of all vents (openings) on the enclosure [m²]

E_v – coefficient of additional amount of extinguishing agent depending on value A_v [kg/m²]

$$A_v/A_t \times 100 = [\%]$$

if the result of the formula above is lower than 1 %, then $E_v = 0$

if the result of the formula above is higher than 1 % and lower than 5 %, then $E_v = 2.44 \text{ kg/m}^2$

if the result of the formula above is higher than 5 % and lower than 15 %, then $E_v = 4.88 \text{ kg/m}^2$

$$E = V_t \times 0.5 + E_{add} \text{ [kg]} \quad (6)$$

E – total amount of extinguishing agent required [kg]

0.5 – given amount of extinguishing agent per 1 m³ [kg/m³]

$$A_f = W \times L \text{ [m}^2\text{]} \quad (7)$$

A_f – floor area of the enclosure

$$N = A_f/4 \text{ [pcs]} \quad (8)$$

N – number of nozzles [pcs]*

4 – max. area coverage per one nozzle [m²]

*If the resulting number is lower than 1, round the value up to 1; if the result is higher than 1, round the result to the nearest even integer

Calculation example for an enclosures with less than 2.5 % of openings of the total enclosure area:

Given values for an enclosure:

$$W = 1.16 \text{ m} \quad L = 5.02 \text{ m} \quad H = 1.38 \text{ m} \quad A_v = 0.72 \text{ m}^2$$

Given values for a permanent solid object:

$$W_{po} = 0.80 \text{ m} \quad L_{po} = 4.50 \text{ m} \quad H_{po} = 1.00 \text{ m}$$

Calculation procedure:

$$V = W \times L \times H = 1.16 \times 5.02 \times 1.38 = 8.04 \text{ m}^3$$

$$V_{po} = W_{po} \times L_{po} \times H_{po} = 0.80 \times 4.50 \times 1.00 = 3.60 \text{ m}^3$$

$$V_t = V - V_{po} = 8.04 - 3.60 = 4.44 \text{ m}^3$$

$$A_t = 2(W \times L) + 2(W \times H) + 2(H \times L) = 2(1.16 \times 5.02) + 2(1.16 \times 1.38) + 2(5.02 \times 1.38) = 28.70 \text{ m}^2$$

$$A_v/A_t \times 100 = \frac{0.72}{28.70} \times 100 = 2.5 \% \Rightarrow E_v = 2.44 \text{ kg/m}^2$$

$$E_{add} = A_v \times E_v = 0.72 \times 2.44 = 1.76 \text{ kg}$$

$$E = V_t \times 0.5 + E_{add} = 4.44 \times 0.5 + 1.76 = 3.98 \text{ kg}$$

$$A_f = W \times L = 1.16 \times 5.02 = 5.82 \text{ m}^2$$

$$N = A_f/4 = \frac{5.82}{4} = 1.46 \Rightarrow 2 \text{ nozzles}$$

Recommended system: CPO2xx-xx-4-2

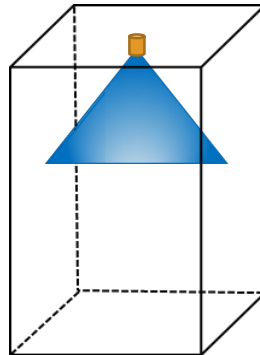

Nozzle orientation downward and centralised for total flooding enclosures

3.3 LOCAL APPLICATIONS

A local application is an area with openings above 15 % of the total area but it is not fully open. A good example of this is generator rooms where you have open areas, but it is still considered to be a partially closed environment. However, applications that have less than 15 % openings can also be included as a local application.

The calculation is based on

- 1.0 kg per 1 m² and is based on manufacturer’s testing for local applications.

A combination of ANP160 and ANP120 nozzles can be used in local applications to ensure the most effective coverage is achieved. Location of nozzles must always be above or centred with the application and the nozzles oriented horizontal, vertical or downwards, so a full application of powder is achieved.

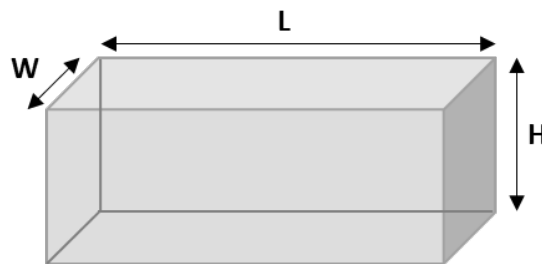

Simplified model of the protected hazard

$$A = W \times L + 2(W \times H) + 2(H \times L) \tag{9}$$

A – surface of the protected hazard [m²]

W – width [m]

L – length [m]

H – height [m]

* The bottom of the application is excluded as agent will cover it indirectly.

Table 6: Coverage limitations for local applications based on 1.0 kg/m²

Cylinder volume [L]	Total agent [kg]	Discharge ports used	Nozzles per discharge port	Nozzle types	Max surface coverage per nozzle [m ²]	Distance from nozzle to application surface	System surface area coverage [m ²]
2.4	2	1	1	1 x ANP1x0	2.0	250 – 800 mm (250 – 1500 mm)*	2.0
		1	2	2 x ANP1x0	1.0		
5.0	4	1	2	2 x ANP1x0	2.0	250 – 800 mm (250 – 1500 mm)*	4.0
		1	3	3 x ANP1x0	1.3		
7.8	6	1	2	2 x ANP1x0	3.0	250 – 800 mm (250 – 1500 mm)*	6.0
		1	3	3 x ANP1x0	2.0		
		2	2	4 x ANP1x0	1.5		
13.0	10	2	2	4 x ANP1x0	2.5	250 – 800 mm (250 – 1500 mm)*	10.0
		2	3	6 x ANP1x0	1.6		
16.0	12	2	2	4 x ANP1x0	3.0	250 – 800 mm (250 – 1500 mm)*	12.0
		2	3	6 x ANP1x0	2.0		

NOTE

**values for ANP160 nozzle*

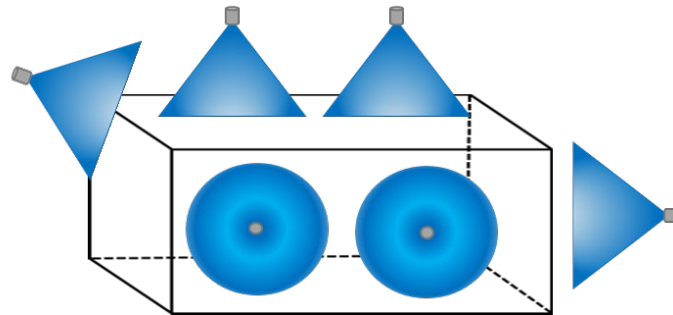

Possible nozzle orientation options for a local application

4 COMPONENTS OF THE SYSTEM AND THEIR DESCRIPTION

4.1 CYLINDERS FOR EXTINGUISHING AGENT

Depending on the system configuration and the necessary amount of the extinguishing agent different size cylinders filled with the necessary amount of extinguishing agent may be used. The set size and selected parameters of normally used cylinders and valves are shown in pictures and table below.

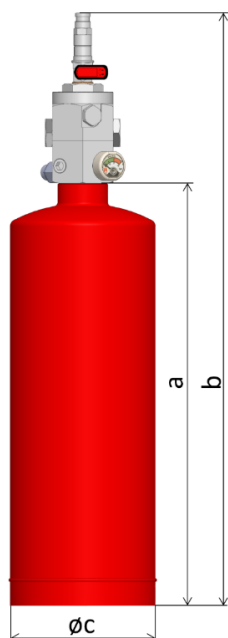

Cylinder with the valve 201

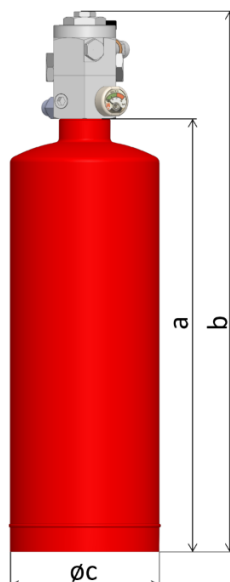

Cylinder with the valve 207

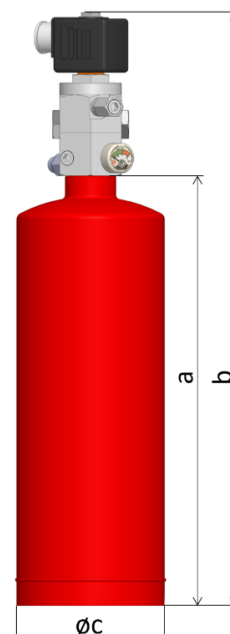

Cylinder with the valve 21x

Table 7: Parameters and dimensions of cylinders including a valve

Volume of the cylinder [L]	Valve	M** [kg]	a* [mm]	b* [mm]	Ø c [mm]	Max. amount of agent [kg]
2.4	201, 202, 203	2.59	320	445	110	2
	207	2.59		399		
	211, 212	2.87		441		
5.0	201, 202, 203	3.53	348	473	150	4
	207	3.53		427		
	211, 212	3.82		469		
7.8	201, 202, 203	4.41	460	585	160	6
	207	4.41		539		
	211, 212	4.70		581		
13.0	201, 202, 203	6.11	533	658	190	9
	207	6.12		612		
	211, 212	6.40		654		
16.0	201, 202, 203	8.17	645	770	190	12
	207	8.17		724		
	211, 212	8.45		766		

*tolerance ± 3 mm

**weight of the empty cylinder with the valve and without the extinguishing agent, tolerance ± 0.05 kg

Table 8: Cylinders parameters

Parameter	Description
Certification	2014/68/EU
Material	steel DC04 EN10130
Surface treatment	high resistant powder coating
Neck ring	stainless steel 316L AISI/EN 1.4435/1.4404
Inside surface	polymer coating
Max. working pressure	PS 30 bar at 60 °C
Working temperature	-30 to +60 °C
Testing pressure	PT 43 bar
Colour	red RAL 3000



System model: CPO2xx
 System kit: CPO2xx-xx-2-x-x
 Amount of agent: 2 kg
 Cylinder volume: 2.4 L
 Serial number: 0000001
 Production week: 01-2023

Cylinder label with model designation and production data

The cylinder is used for storage of extinguishing agent and expellant gas. The expellant gas is required to release the agent through the nozzle(s) and also assists in the stabilization of pressure in the cylinder. Pressure in the cylinder will vary depending on the ambient temperature (see graph below). The amount of the extinguishing agent and its fill pressure are indicated on the label of the cylinder. The cylinder arrives unpressurised as standard.

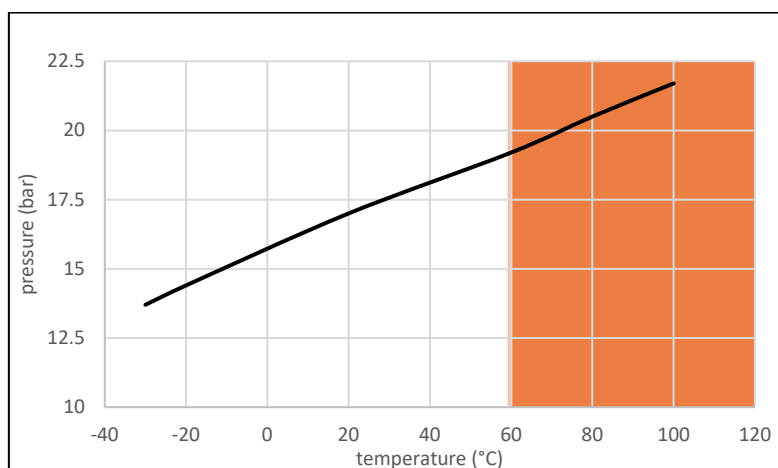

The relationship between temperature and pressure in the cylinder

Table 9: Values of pressure in the cylinder at given temperatures

Temperature [°C]	-30	-20	-10	0	10	20	30	40	50	60
Pressure [bar]	20.5	21.4	22.3	23.2	24.1	25	26	27	28	29

4.1.1 WARNINGS



In case of a significant difference between the actual pressure in the system with the data on the cylinder label, conduct an inspection of the system.



Do not install the cylinder, if the incorrect pressure is detected in the cylinder during inspection (i.e., pressure is significantly different from the values stated on the label).



The cylinder of the system is under constant pressure. Do not damage, puncture or throw the cylinder. During transferring or transporting, secure the cylinder to avoid tipping, rolling or rubbing against other objects or the ground. Do not mend or solder a damaged cylinder, it must be replaced.



During storage, separate empty cylinders from fully charged cylinders and appropriately label their storage area. Do not store or transport in vicinity of strong sources of heat, aggressive chemical (caustic, corrosive) substances, prevent contact with sharp objects, vibrations or loading with other objects. Store in dry and well-ventilated rooms.



Do not expose the cylinder to extreme heat or direct sunlight if possible. Heating the surface of the cylinder may significantly increase pressure in the cylinder.



Always handle the cylinder as if it was under pressure, unless it is directly verified that it is completely empty (e.g., by pressing the Schrader valve in the M10x1 pressure gauge outlet on the cylinder valve; the value of the pressure on the pressure gauge may be incorrect or the pressure gauge may be malfunctioning).



Transportation of equipment under pressure by transportation vehicles is governed by specific legislation. Seek information and follow corresponding security requirements during transportation depending on the method of transport.

4.1.2 SIMULTANEOUS CONNECTION OF MULTIPLE CYLINDERS

In case of simultaneous connection of multiple cylinders, the extinguishing agent in all cylinders must be the same and all containers must be under the same pressure before installation.

The amount of extinguishing agent in each cylinder is indicated on the label of the cylinder, the total amount of the extinguishing agent in the system is the sum of the quantities of extinguishing agent in individual cylinders. The cylinders are connected into one pressurised unit after installation of the system, the pressure in all cylinders at steady state is always equal.

4.2 CYLINDER VALVES

The cylinder valve is assembled and part of the cylinder when the BlazeCut system is supplied. The valve is closed by an internal piston, which holds the pressure in the cylinder. The piston opens with a rapid decrease of pressure on the top side of the piston. This can be caused by a pneumatic activation or with an electric activation using an electric solenoid.



Prevent the cylinder valve from damage and impact. Do not lift the cylinder holding it by the cylinder valve or by other components connected to the valve. Always store and transport cylinders with the valve facing upwards.



Do not try to remove the valve off the cylinder if the cylinder is under pressure. Never untighten a plug or fitting closing the detection ports on the cylinder valve. If removed, this can cause the immediate opening of the cylinder valve piston and release the extinguishing agent.



The valve is mounted on the cylinder by a specific tightening torque. Do not tighten or release the valve. If a leak is detected between the valve and cylinder join, the charged cylinder cannot be used.

4.2.1 VALVES 20x WITHOUT THE INTEGRATED SOLENOID – SYSTEMS CPO20x

Pressure that is in the detection circuit keeps the piston in closed position. The piston of the valve will open when there is a drop of pressure in the detection circuit which is connected to the top side of the cylinder valve. This principle is solely mechanical and independent of any external power supply. The piston can be also released by a manual actuation device.

Valve Series 20x are mostly used in LOP applications with BlazeTube detection. A pneumatic hose can be used for connecting directly to a remote actuator, for a manual system only, when required.

Table 10: Parameters of valves 201, 202, 203

Total height of the valve	Height of the valve without the cylinder thread	Cylinder thread	Dip tube thread	Distribution outlet thread	Pressure gauge thread	BlazeTube detection outlet	Ball valve thread
141 mm	125 mm	M30x1.5	M16x1.5	G3/8"	M10x1	Ø 6 mm	G1/8"

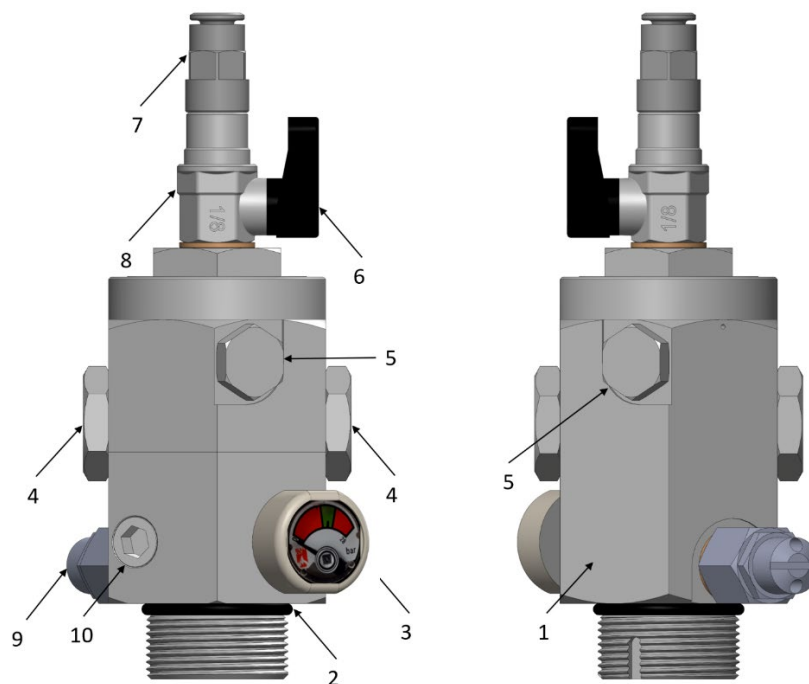

Standard configuration of the 201, 202, 203 valves

1. body of the cylinder valve
2. O-ring seal of the cylinder valve
3. M10x1 port with an installed pressure gauge APG006
4. 2x G3/8" agent discharge outlet with a valve plug FVP1B06 – for fittings for a Red Fire Hose, Feed Hose or a steel tube
5. 2x G1/8" outlet with a valve plug FVP1B02. Can be ordered with:
 - a) valve adapter FVABM0210 (G1/8" to M10x1)
 - b) ball valve ABV001 with BlazeTube push-in connector and a bonded seal FVG002
6. removable lever of the ball valve
7. push-in connector for a Ø 6 mm BlazeTube detection
 - a) valve 201: straight fitting FBT1BP026
 - b) valve 202: elbow fitting FBT2BP026
 - c) valve 203: Tee fitting FBT3PBP6026
8. G1/8" outlet with a ball valve ABV001 and a bonded seal FVG002
9. G1/8" outlet with a pressure relief valve APR001 or APR003 and a bonded seal FVG002
10. M10x1 port with a valve plug FVP1M10 – for Pressure Switch APS001-xx, APS003-xx or Pressure Transducer ATA100 (see Annex [A2.4](#))

Table 11: Parameters of the valves 207-01

Total height of the valve	Height of the valve without the cylinder thread	Cylinder thread	Dip tube thread	Distribution outlet thread	Pressure gauge thread	BlazeTube detection outlet	Ball valve thread
95 mm	79 mm	M30x1.5	M16x1.5	G3/8"	M10x1	Ø 6 mm	G1/8"

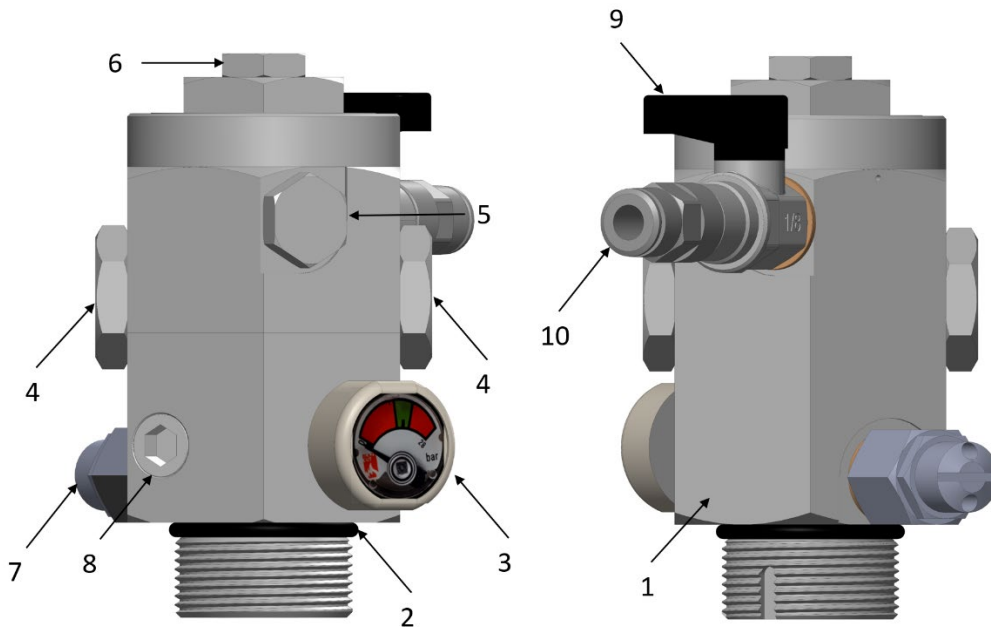

Standard configuration of the 207-01 valve

1. body of the cylinder valve
2. O-ring seal of the cylinder valve
3. M10x1 port with an installed pressure gauge APG006
4. 2x G3/8" agent discharge outlet with a valve plug FVP1B06 – for fittings for a Red Fire Hose, Feed Hose or a steel tube
5. G1/8" outlet with a valve plug FVP1B02. Can be ordered with:
 - a) valve adapter FVABM0210 (G1/8" to M10x1)
 - b) ball valve ABV001 with BlazeTube push-in connector and a bonded seal FVG002
6. G1/8" outlet with a valve plug FVP1B02
7. G1/8" outlet with a pressure relief valve APR001 or APR003 and a bonded seal FVG002
8. M10x1 port with a valve plug FVP1M10 – for Pressure Switch APS001-xx, APS003-xx or Pressure Transducer ATA100 (see Annex [A2.4](#))
9. removable lever of the ball valve
10. G1/8" outlet with a ball valve ABV001 with BlazeTube push-in connector and a bonded seal FVG002
Can be ordered also with:
 - a) valve plug FVP1B02

4.2.2 VALVES 211 AND 212 WITH THE INTEGRATED SOLENOID – SYSTEMS CPO(211, 212)

The solenoid is an electromagnetic coil. When electrical current is sent to the coil, it produces a magnetic field. The field transforms into mechanical energy, which secures the release of pressure from the top side of the valve piston opening the discharge ports and releasing the agent.

The system is supplied with a solenoid connector mounted on the solenoid. When fire is detected, the solenoid allows to activate the system manually (e.g., alarm panel, electric actuator) or automatically using electrical detection such as smoke and/or heat detectors, LHD BlazeWire etc.

Table 12: Parameters of the 211 and 212 valves

Total height of the valve	Height of the valve without the cylinder thread	Cylinder thread	Dip tube thread	Distribution outlet thread	Pressure gauge thread	BlazeTube detection outlet	Ball valve thread
137 mm	121 mm	M30x1.5	M16x1.5	G3/8"	M10x1	Ø 6 mm	G1/8"

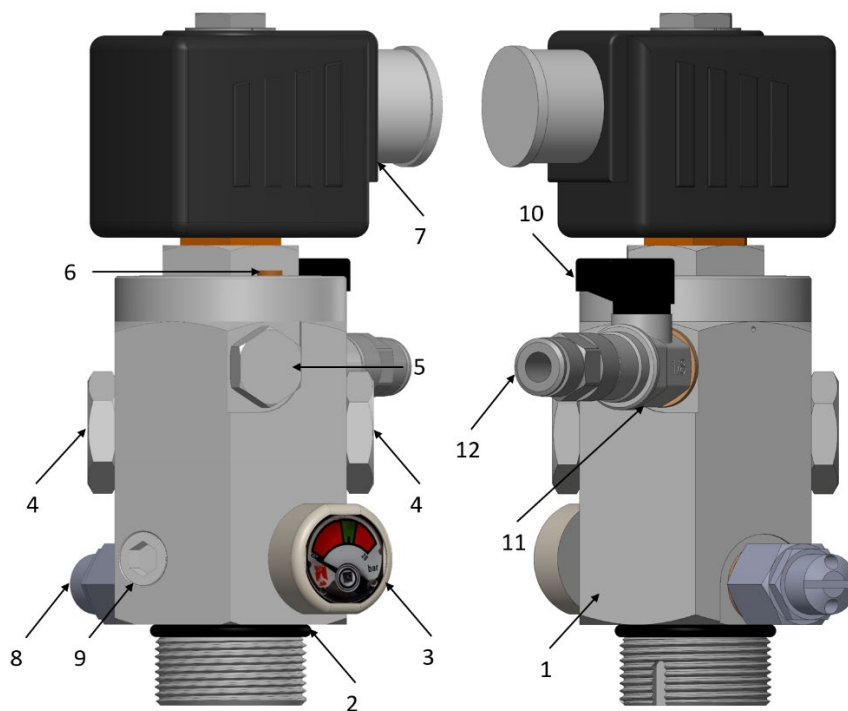

Standard configuration of 21x-01 valves

1. body of the cylinder valve
2. O-ring seal of the cylinder valve
3. M10x1 port with an installed pressure gauge APG006
4. 2x G3/8" agent discharge outlet with a valve plug FVP1B06 – for fitting for a Red Fire Hose, Feed Hose or a steel tube
5. G1/8" outlet with a valve plug FVP1B02. Can be ordered with:
 - a) valve adapter FVABM0210 (G1/8" to M10x1)
 - b) ball valve ABV001 with BlazeTube push-in connector and a bonded seal FVG002
6. venting port cap – **keep in place at all times**
7. solenoid valve 24 V DC or 12 V DC
8. G1/8" outlet with a pressure relief valve APR001 or APR003 and a bonded seal FVG002
9. M10x1 port with a valve plug FVP1M10 – for Pressure Switch APS001-xx, APS003-xx or Pressure Transducer ATA100 (see Annex [A2.4](#))
10. removable lever of the ball valve
11. G1/8" outlet with a ball valve ABV001 and a bonded seal FVG002
12. push-in connector FBT1BP026 for a Ø 6 mm BlazeTube detection

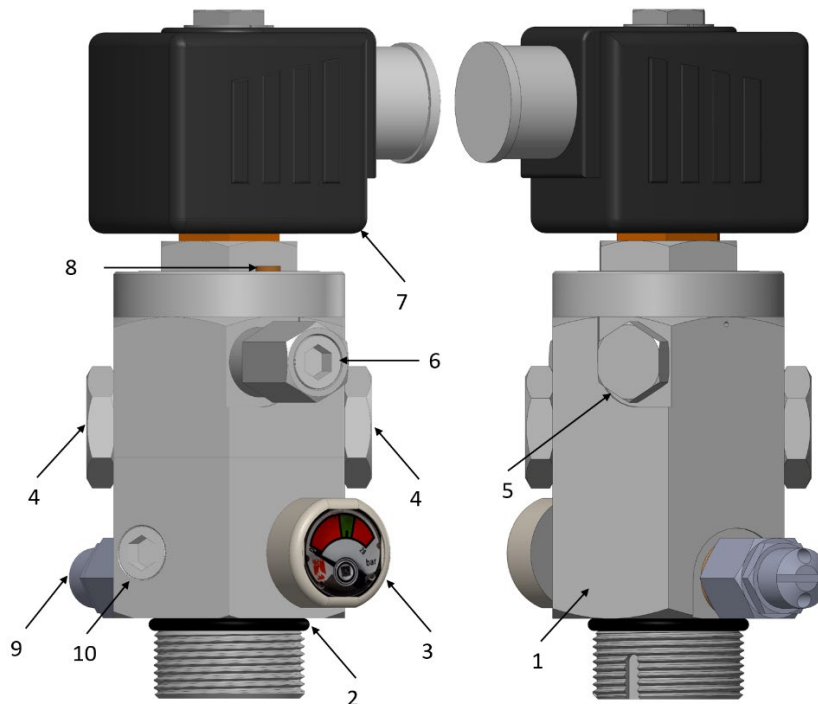

Standard configuration of 21x-30 valves

1. body of the cylinder valve
2. O-ring seal of the cylinder valve
3. M10x1 port with an installed pressure gauge APG006
4. 2x G3/8" agent discharge outlet with a valve plug FVP1B06 – for fittings for a Red Fire Hose, Feed Hose or a steel tube
5. G1/8" outlet with a valve plug FVP1B02. Can be ordered with:
 - a) valve adapter FVABM0210 (G1/8" to M10x1)
 - b) ball valve ABV001 with BlazeTube push-in connector and a bonded seal FVG002
6. G1/8" outlet with a valve adapter FVABM0210 (G1/8" to M10x1) with a plug
7. solenoid valve 24 V DC or 12 V DC
8. venting port cap – **keep in place at all times**
9. G1/8" outlet with a pressure relief valve APR001 or APR003 and a bonded seal FVG002
10. M10x1 port with a valve plug FVP1M10 – for Pressure Switch APS001-xx, APS003-xx or Pressure Transducer ATA100 (see Annex [A2.4](#))

Table 13: Types of solenoid connectors

Part No	IP rating	Description
ASP002	IP67	Solenoid plug for electrics, with integrated seal



ASP002

Please refer to component manual *CM-AP2-EN Alarm Panels AAP210, AAP211, AAP310* for full wiring detail.

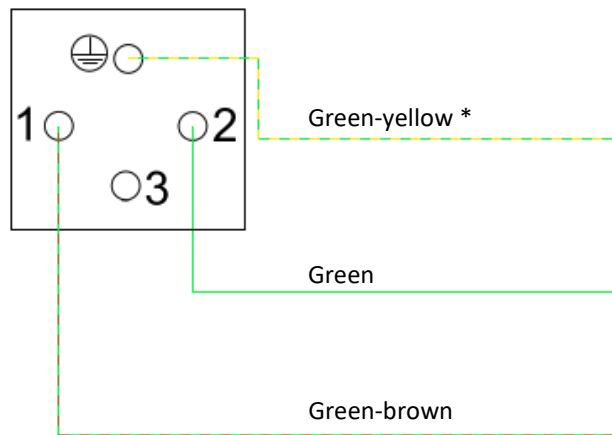
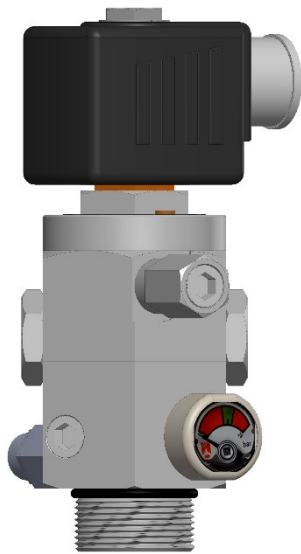

** optional ground wire*

ASP002 wiring diagram

4.2.3 BLAZETUBE DETECTION CONNECTOR

The BlazeTube detection connector with a \varnothing 6 mm outlet is on the cylinder valve. Part of this connector is a small ball valve mounted in the valve detection outlet with thread G1/8". The ball valve is closed when supplied and must only be opened after pressurisation of the BlazeTube detection, for the system to become fully functional.

For safety reasons cylinders under pressure must be protected against accidental activation by removal of the lever of the ball valve during transportation of the cylinder. Install the lever during installation of the BlazeTube detection. During the installation of the ball valve lever, follow the steps listed below. To uninstall the ball valve lever, remove the red cover by pushing its pin on the back and follow the steps backwards to the installation.

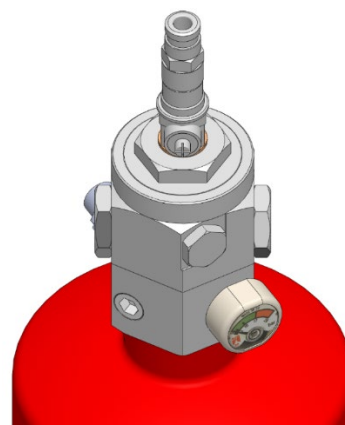
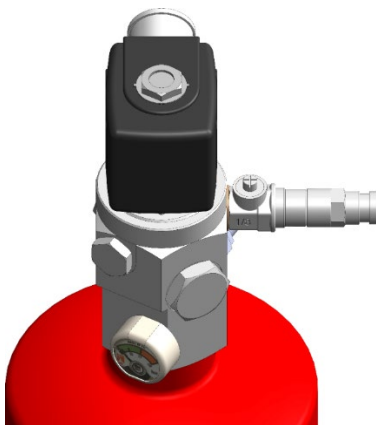



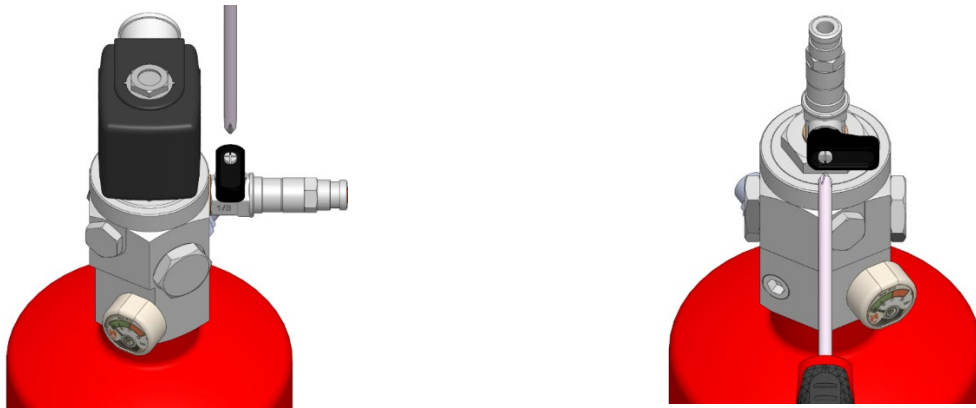

Ball valves without a lever

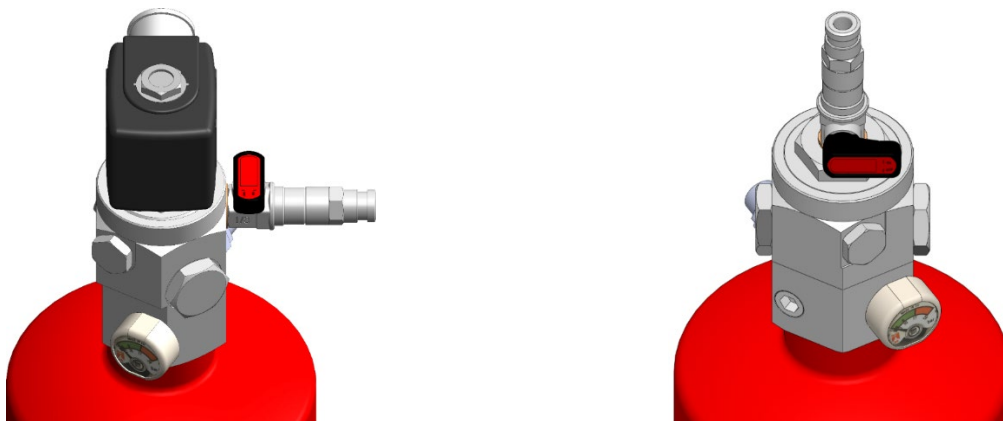

Use a screwdriver for mounting and dismantling



Place the red cover on the lever

-  Do not try to remove the BlazeTube detection ball valve connector from the cylinder valve if the system is under pressure. This will cause the cylinder valve to activate and discharge the agent.
 -  Always remove the lever of the ball valve during transportation of cylinders which are under pressure.
 -  Do not open the ball valve of the BlazeTube detection connector before pressurisation of the tube, the valve piston of the cylinder will open and the extinguishing agent will be released. Protect the ball valve from accidental opening during transportation and handling of the cylinder. Follow the instructions for transportation of the cylinder.
 -  Always keep the discharge ports on the valve plugged until the BlazeTube detection is pressurised to the correct pressure.
- The ball valve of the BlazeTube detection connector can only be opened after completing the following:
-  - the cylinder of the system is properly fastened;
 - the system is completely installed, without discharge hoses connected;
 - both discharge outlets are to remain plugged off until charging is completed correctly;
 - the BlazeTube detection is properly connected to the valve and to the end-of-line adapter;
 - the end-of-line adapter is properly mounted and secured with a P-clamp;
 - the BlazeTube detection is pressurised to 1 bar above the current cylinder pressure.

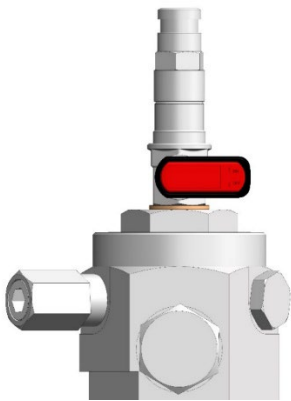

Ball valve is closed

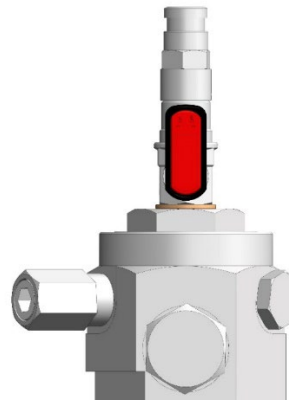

Ball valve is open

To prevent unintentional switch of the ball valve lever to closed position, install the ball valve anti tamper safety lock ABL001 and a plastic lock seal ALS001.

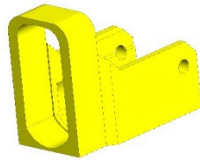

Ball valve anti tamper safety lock ABL001

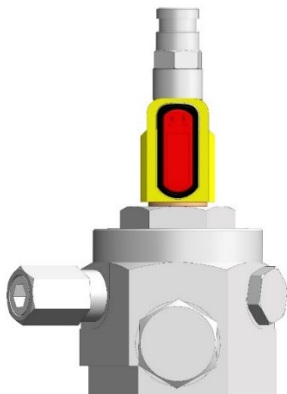

Installed ball valve anti tamper safety lock

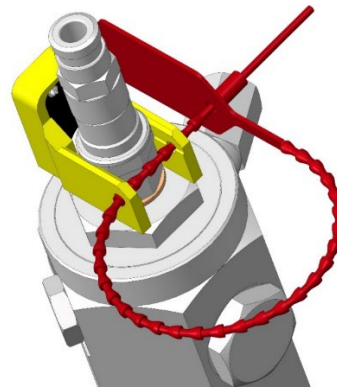

Installed plastic lock seal

Put the ball valve anti tamper safety lock in position so that the front face of it and the front face of the ball valve lever are in plane. To secure the ball valve anti tamper safety lock, insert a plastic lock seal through the two holes on the ball valve anti tamper safety lock. Fasten the lock seal tightly.

4.2.4 DISCHARGE OUTLET

The cylinder valve contains two outlets for the discharge networks. They are closed by the valve piston of the cylinder. The outlets have a thread G3/8". These outlets are sealed with plugs to prevent accidental activation of the system when the BlazeCut system is supplied and installed.



The valve plugs of the outlets for discharge networks must always remain on the cylinder valve. Remove the valve plugs after the BlazeTube has been charged correctly and the ball valve has been successfully opened without issue. The connecting of discharge hoses will be one of the last steps in the systems installation process.

Table 14: Parts for the cylinder valve

Picture	Part №	Description	Material
	FDO1BM0618	discharge outlet fitting straight reduced coupling G3/8" for 12 mm tube (M18x1.5) - BODY, Male-Male,	galvanized steel
	FDO1BM0618-SET	discharge outlet fitting straight reduced coupling G3/8" for 12 mm tube (M18x1.5) - SET, Male-Male	galvanized steel
	FDO1BM0622	discharge outlet fitting straight reduced coupling G3/8" for 15 mm tube (M22x1.5) - BODY, Male-Male	galvanized steel
	FDO1BM0622-SET	discharge outlet fitting straight reduced coupling G3/8" for 15 mm tube (M22x1.5) - SET (with rings and nuts), Male-Male	galvanized steel
	FDO1BB0604	discharge outlet fitting straight reduced coupling, G3/8" for 1/4" RF hose (G1/4"), Male-Male	galvanized steel
	FDO1BB0608	discharge outlet fitting straight reduced coupling, G3/8" for 1/2" RF hose (G1/2"), Male-Male	stainless steel
	FDO1BB0608-G	discharge outlet fitting straight reduced coupling, G3/8" for 1/2" RF hose (G1/2"), Male-Male	galvanized steel
	FVABM0210	valve adaptor G1/8" - M10x1 with internal Schrader valve, includes M10x1 plug	stainless steel, EPDM sealing
	APR001-32	Pressure relief valve for ILP/DLP valves, 32 bar set pressure, G1/8"	stainless steel, EPDM sealing
	FVP1B02	valve plug G1/8"	stainless steel EPDM sealing

	FVP1B06	valve plug G3/8"	stainless steel EPDM sealing
	FVP1M10	valve plug M10x1	stainless steel EPDM sealing
	FVG002	Bonded seal, 1/8", used with ball valve ABV001 and pressure relief valve APR001 or APR003	stainless-steel, EPDM seal
	ABV001	ball valve G1/8" to G1/8"	chrome nickel-plated brass body, EPDM sealing
	ABL001	Ball valve anti tamper safety lock with lock seal	plastic

4.3 PRESSURE GAUGE

Actual pressure in the cylinder can be determined by reading the value on the pressure gauge, which is mounted on the cylinder valve, alternatively an additional gauge on the end-of-line adapter or pneumatic remote actuator ARA010 or ARA020. Green zone of the pressure gauge indicates the permissible pressure in the system.

Table 15: Pressure gauge

Part No	Description	Pressure range	Thread	Material
APG006	for ABC Powder systems	green zone: 20 – 29 bar red zones: 0 – 19 bar, 29 – 32 bar	M10x1	body: nickel plated brass O-ring: EPDM



APG006

When the system is supplied, the pressure gauge is mounted on the cylinder valve in the bottom outlet with a thread M10x1. It is always recommended to keep the pressure gauge located in the same position as it was supplied. If there is a need for the pressure gauge relocation, follow instructions in Annex [A2.4](#).

Always place the pressure gauge so that the value of pressure is clearly visible.



Before installation of a pressure transducer, pressure switch or a pressure gauge to the ports on the cylinder valve, the cylinder has to be unpressurised.



If the system is in operation and the BlazeTube detection under pressure, when mounting and dismantling the pressure gauge at the end-of-line device, the ball valve on the cylinder valve must be closed to avoid a false actuation.

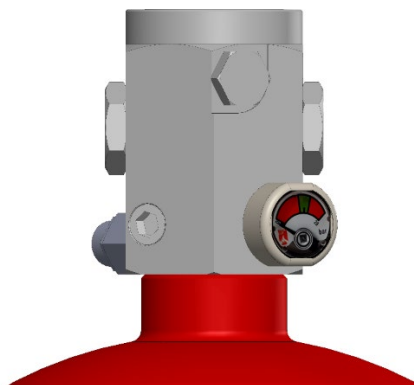

Standard location of a pressure gauge

4.4 BLAZETUBE DETECTION

The BlazeTube detection works on pneumatic principles and is an automatic activator of the BlazeCut system. BlazeTube is manufactured to fulfil the highest market standards and combining key features like high chemical resistance, long lifetime, UV stability, flexibility and reliable fire detection.

BlazeTube is connected to the valve using the BlazeTube detection outlet with the push-in connector FBT1BP026. The BlazeTube has an end of line device at the opposing end. The BlazeTube detection is placed in the protected enclosure. During installation the tube is pressurised by nitrogen gas and this keeps the piston of the cylinder valve closed. Pressure in the tube and in the cylinder is the same during the operation of the system. During fire the tube ruptures where the fire and temperature are at their greatest. This immediately decreases pressure in the tube and opens the piston of the cylinder valve. The fire suppression system activates and releases the extinguishing agent without any delay.

The time taken to cause the rupture of the BlazeTube detection may vary and depends on the pressure in the tube, which is affected by the level of pressurisation in the system and ambient temperature. The higher the pressure in the BlazeTube detection, the sooner the BlazeTube detection ruptures and activates the system.

Table 16: BlazeTube detection parameters

Parameter	Property
material	special heat sensitive plastic
colour	red RAL3000
outside diameter	6 mm
operating temperature	-30 to +110 °C
activation temperature	about 170 °C
life span	up to 10 years



BlazeTube
Detection ABT170

Table 17: Compatibility with selected common chemicals

Name	Status	Name	Status
Sodium Hydroxide, 35 %	OK	Standard fuel with alcohol	OK
Ammonium Hydroxide, 10 %	OK	Standard fuel without alcohol	OK
Isopropyl alcohol	OK	Sodium Carbonate, 20 %	OK
Ethanol	OK	Sodium Hypochlorite, 10 %	OK
Methanol	OK	Sodium Chloride, 10 %	OK
Diethyl ether	OK	Zinc Chloride, 50 %	OK
Acetone	OK	Citric Acid, 10 %	OK
Toluene	OK	Acetic Acid, 5 %	OK
Hexane	OK	Sulfuric Acid, 38 %	OK
iso-Octane	OK	Lactic Acid, 10 %	OK
Insulating Oil	OK	Ethylene Glycol in water, 50 %	OK
Multi-grade motor oil	OK	Hydrogen peroxide	OK
Hypoid gear oil	OK	Ethyl Acetate	OK
Diesel fuel	OK	Water	OK

Table 18: Types of BlazeTube detection

Part No	Description
ABT170	∅ 6 mm BlazeTube detection suits valve types 201, 202, 203, 20x-01, 21x-01

Table 19: BlazeTube detection standard kits

Part No	Description
KABT170-005	∅ 6 mm BlazeTube 5 metres, cable gland ACG112, 20 cable ties ACT314, 2 labels ALA018
KABT170-010	∅ 6 mm BlazeTube 10 metres, cable gland ACG112, 40 cable ties ACT314, 4 labels ALA018
KABT170-015	∅ 6 mm BlazeTube 15 metres, cable gland ACG112, 60 cable ties ACT314, 6 labels ALA018
KABT170-020	∅ 6 mm BlazeTube 20 metres, cable gland ACG112, 80 cable ties ACT314, 8 labels ALA018
KABT170-030	∅ 6 mm BlazeTube 30 metres, cable gland ACG112, 120 cable ties ACT314, 12 labels ALA018
KABT170-040	∅ 6 mm BlazeTube 40 metres, cable gland ACG112, 160 cable ties ACT314, 16 labels ALA018

Table 20: BlazeTube detection heavy-duty kits

Part No	Description
KABT170-005-HD	∅ 6 mm BlazeTube 5 metres, cable gland ACG112, 10 P-clamps APC020, 10 grommets AGBT005, 2 labels ALA018
KABT170-010-HD	∅ 6 mm BlazeTube 10 metres, cable gland ACG112, 10 P-clamps APC020, 20 grommets AGBT005, 4 labels ALA018
KABT170-015-HD	∅ 6 mm BlazeTube 15 metres, cable gland ACG112, 10 P-clamps APC020, 30 grommets AGBT005, 6 labels ALA018
KABT170-020-HD	∅ 6 mm BlazeTube 20 metres, cable gland ACG112, 10 P-clamps APC020, 40 grommets AGBT005, 8 labels ALA018
KABT170-030-HD	∅ 6 mm BlazeTube 30 metres, cable gland ACG112, 10 P-clamps APC020, 60 grommets AGBT005, 12 labels ALA018
KABT170-040-HD	∅ 6 mm BlazeTube 40 metres, cable gland ACG112, 10 P-clamps APC020, 80 grommets AGBT005, 16 labels ALA018



BlazeTube detection standard kit



BlazeTube detection heavy duty kit

4.5 BLAZETUBE PUSH-IN CONNECTORS

BlazeCut double seal push-in connectors provide a double tight connection on the BlazeTube, thus ensuring a highly reliable connection and avoiding possible leakage that may occur. Connection and disconnection of the tube can be repeated several times without the use of proper tools and without compromising the performance of the connector and the sealing of the tube.

The BlazeTube detection can be connected through Tee, elbow or straight push-in connectors. It is recommended to minimise the use of connectors and install them low in the main fire risk areas to avoid high temperatures during the operation of the equipment.

Table 21: BlazeTube push-in connectors

Part No	Description	Working temperature	Working pressure	Material
FBT1PP66	straight push-in connector for BlazeTube \varnothing 6 mm, NBR	-20 to +80 °C	0.9 – 60 bar	body and gripper: nickel-plated brass seals: EPDM or NBR
FBT3PPP666	Tee push-in connector for BlazeTube \varnothing 6 mm, NBR	-30 to +80 °C		
FBT1BP026	outlet push-in connector for BlazeTube \varnothing 6 mm, G1/8", EPDM			
FBT2BP026	elbow push-in connector 360° rotation for BlazeTube \varnothing 6 mm, G1/8", EPDM			
FBT3PBP6026	Tee push-in connector 360° rotation for BlazeTube, \varnothing 6 mm, G1/8", EPDM			



FBT1PP66

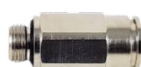

FBT1BP026



FBT3PPP666



FBT2BP026



FBT3PBP6026

4.6 BLAZETUBE END-OF-LINE DEVICES

Table 22: List of end-of-line devices

Part No	Description
FBT1P6	End-of-line plug \varnothing 6 mm
AEA006	End-of-line adapter \varnothing 6 mm with standard push-in connector for BlazeTube
ARA010-P	Remote actuator pneumatic, bulkhead mount*
ARA020-P	Remote actuator pneumatic, boxed mount*
ARA110	Remote actuator electric, bulkhead mount*
ARA120	Remote actuator electric, boxed mount*

*see Annex for detail description.

4.6.1 END-OF-LINE PLUG

End-of-line plugs are used to close one of the BlazeTube detections when branching the BlazeTube.

Table 23: Types of end-of-line plugs

Part No	Description	Working temperature	Working pressure	Material
FBT1P6	End-of-line plug \varnothing 6 mm	-30 to +80 °C	0.9 – 60 bar	body and gripper: nickel-plated brass seals: EPDM



FBT1P6

4.6.2 END-OF-LINE ADAPTER

BlazeTube end-of-line adapter is used for pressurisation of the BlazeTube detection system when the system is installed (see Chapter 7.1) and for pressurisation of the system during inspection (see Chapter 8.2).

IMPORTANT!

The end of the adapter with internal thread M10x1 must be occupied by a pressure gauge, Pressure Switch APS001 or Pressure Transducer ATA100, to protect the Shrader valve inside.

Table 24: End-of-line adapter

Part №	Description	Working temperature	Working pressure	Thread
AEA006	End-of-line adapter \varnothing 6 mm with push-in connector, EPDM	-30 to +80 °C	0.9 – 60 bar	M10x1 to connect the pressure gauge or pressure switch/transducer

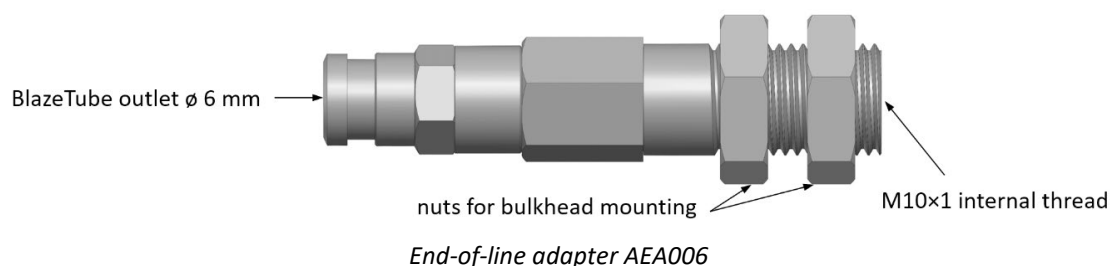

Table 25: End-of-line adapter accessories and kit

Part №	Description
ANE001	spare nut for end-of-line adapter AEA006 and AEA008, M14x1.5, galvanized steel
KCEA006-P	end-of-line adapter for 6 mm BlazeTube detection, APG006 pressure gauge and P-clamp APC014



ANE001



End-of-line adapter kit

4.7 BLAZEWIRE

BlazeWire Linear Heat Detector is a cable constructed using two twisted and tensioned, tri-metallic conductors. Each of the conductive cables are coated in a heat sensitive polymer which, when heated to its rated temperature, melts, causing the two wires to touch. The resulting short sends a signal to the alarm panel, indicating that a fire (or excessive heat) has been detected. This action takes place at the first heated point anywhere along the Blaze Wire's length, which can be up to 50 metres in length. It does not require that a specific length be heated in order to initiate an alarm nor is system calibration necessary to compensate for changes in the installed ambient temperature.

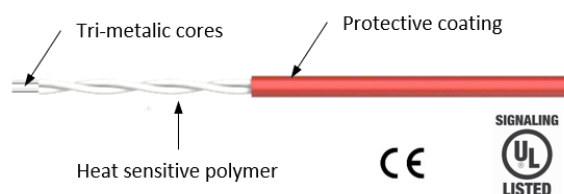

BlazeWire is specifically designed for use in applications where extreme environmental and product performance must be met. It provides excellent abrasion resistance and excellent chemical and permeation resistance to a wide variety of acids, bases, organic solvents as well as simple gases. In addition, the jacket exhibits very little change in tensile properties upon outdoor exposure to sunlight and weather.

Table 26: Types of BlazeWire

Part No	Colour	Outside diameter	Max. recommended ambient temperature	Activation temperature	Length
ABW105	black	4.50 ± 0.12 mm	70 °C	105 °C	per metre, max. 50 m
ABW185	red	3.60 ± 0.12 mm	125 °C	185 °C	

Table 27: Common BlazeWire parameters

Parameter	Property
maximum voltage rating	30 V AC, 42 V DC
resistance	100 Ω/km per leg
minimal bend radius	50 mm
minimum operation temperature	-40 °C

Features

- line coverage - continuous sensitivity up to 50 metres,
- 185 °C (365 °F) or 105 °C (221 °F) temperature rating. (Other temperatures available for special projects);
- withstands severe environmental conditions;
- approved for hazardous locations;
- easy to install, test, and splice;
- compatible with other initiation devices on same circuit. (Detectors, actuators);
- UL 521 Approved and compliant with the EN54:28 standard;
- complies with the CPR, EMC and the Low Voltage Directive (LVD).



5 m coil of BlazeWire ABW185

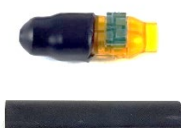

End of line resistor AER001 with heat shrink

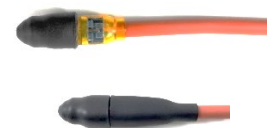

Silicone cable connected with the AER001 and covered with heat shrink

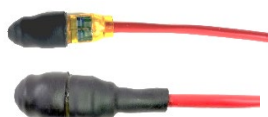

BlazeWire connected with the ER001 and covered with heat shrink



Silicone cable and BlazeWire connected to the Electrical splice AES3550-2



Silicone cable and BlazeWire connected to Electrical splice AES3550-2 heat shrink covered

The BlazeWire must be installed above main fire risk areas. Make sure it is not in direct contact with parts of the protected equipment or close to parts that reach high temperatures during operation. Some examples are engine turbos and exhausts, heat diffusers etc.

When using BlazeWire or other electric detection, the end of detection line must be secured by the End-of-line Resistor (EOR) AER001 that is supplied in a kit. It is recommended to keep the EOR low in the main fire risk areas to avoid heat sources, so it is not exposed to the risk of damage. Maximum allowed operation temperature of the EOR AER001 is 100 °C. The resistor is supplied with a glue heat shrink that is placed over the resistor and BlazeWire when spliced to the resistor connector to seal and hold it firmly to the BlazeWire. The EOR with equal parameters can be yellow or transparent in colour.

It is recommended to use the Electrical Splice AES3550-2 with the heat shrink between the BlazeWire and electrical cable for firm hold and sealing. The Electrical splice connectors are supplied in the BlazeWire kits. See below pictures for suggested installation of the Electrical splice connector. The Electrical splice with equal parameters can be yellow or transparent in colour. It is not necessary to install the BlazeWire in whole length from the protected enclosure to the alarm panel. The BlazeWire can be used in the main fire risk area and

standard or silicone cable can be used to connect to the alarm panel. See below figures for possible connection options.

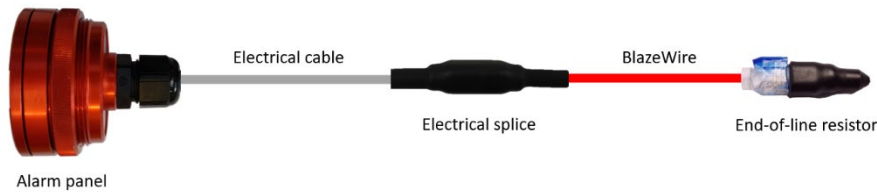

Connection of the BlazeWire to the alarm panel

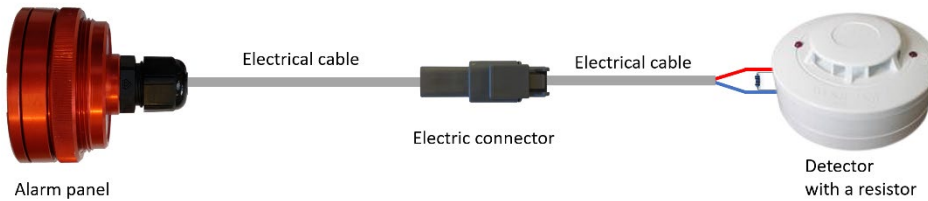

Connection of a detector to the alarm panel

When installing two or more relay detectors, they have to be connected in parallel. The furthest one requires a resistor AER101 installed.

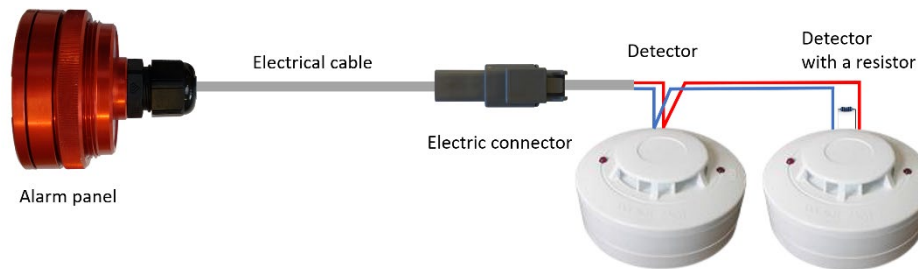

Parallel connection of two detectors to the alarm panel

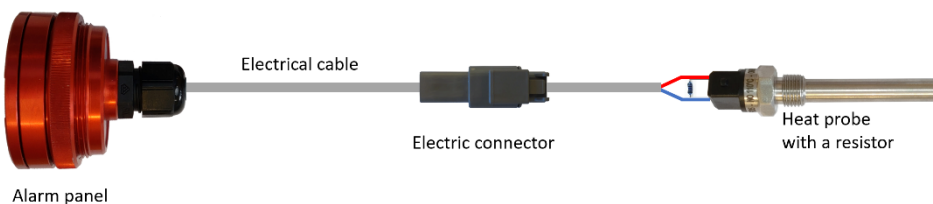

Connection of a heat probe to the alarm panel

When installing two or more heat probes, they have to be connected in parallel. The furthest one requires a resistor AER101 installed. For specifications and connection details see see the component manual *CM-HPD-EN Heat Probe Detector*.

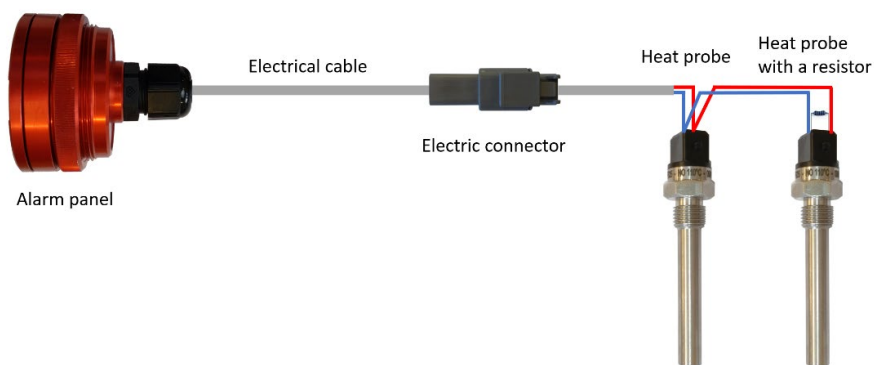

Parallel connection of two heat probes to the alarm panel

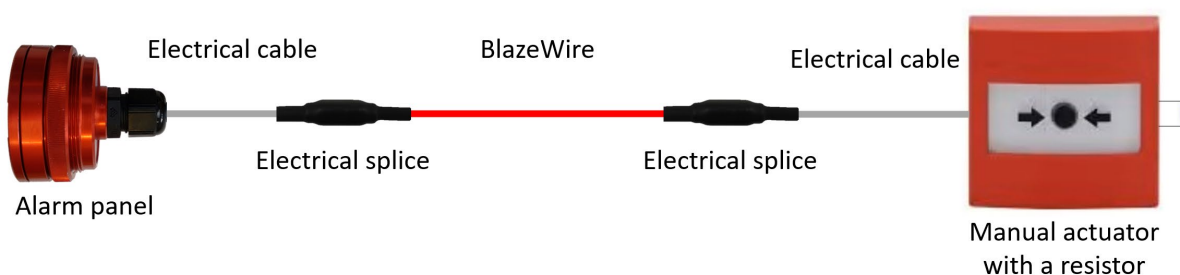

Connection of the BlazeWire and a manual electric actuator to the alarm panel

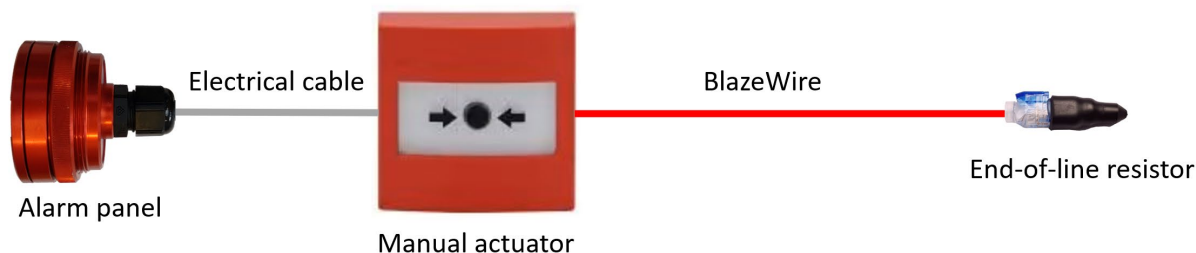

Connection of a manual electric actuator and the BlazeWire to the alarm panel

When installing two or more manual electric actuators, they have to be connected in parallel. The furthest one requires a resistor AER101 installed.

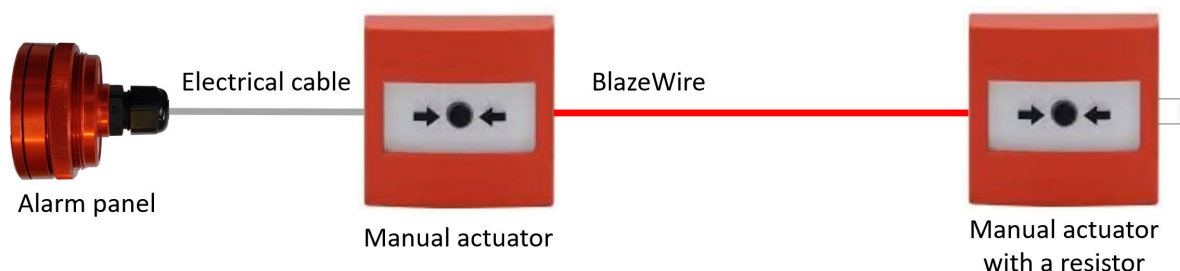

Parallel connection of two manual electric actuators and the BlazeWire to the alarm panel

Table 28: Standard BlazeWire kits

Part No	Content
KABW185-005	5 metres 185 °C BlazeWire, 3x Electrical Splice connector AES3550-2, 3x Heat Shrink AHS001, End-of-line Resistor AER001, P-clamp APC014, 20x Cable Ties ACT314 and 2x label ALA018
KABW185-010	10 metres 185 °C BlazeWire, 3x Electrical Splice connector AES3550-2, 3x Heat Shrink AHS001, End-of-line Resistor AER001, P-clamp APC014, 40x Cable Ties ACT314 and 4x label ALA018
KABW185-015	15 metres 185 °C BlazeWire, 3x Electrical Splice connector AES3550-2, 3x Heat Shrink AHS001, End-of-line Resistor AER001, P-clamp APC014, 60x Cable Ties ACT314 and 6x label ALA018
KABW185-020	20 metres 185 °C BlazeWire, 3x Electrical Splice connector AES3550-2, 3x Heat Shrink AHS001, End-of-line Resistor AER001, P-clamp APC014, 80x Cable Ties ACT314 and 8x label ALA018
KABW105-005	5 metres 105 °C BlazeWire, 3x Electrical Splice connector AES3550-2, 3x Heat Shrink AHS001, End-of-line Resistor AER001, P-clamp APC014, 20x Cable Ties ACT314 and 2x label ALA018
KABW105-010	10 metres 105 °C BlazeWire, 3x Electrical Splice connector AES3550-2, 3x Heat Shrink AHS001, End-of-line Resistor AER001, P-clamp APC014, 40x Cable Ties ACT314 and 4x label ALA018
KABW105-015	15 metres 105 °C BlazeWire, 3x Electrical Splice connector AES3550-2, 3x Heat Shrink AHS001, End-of-line Resistor AER001, P-clamp APC014, 60x Cable Ties ACT314 and 6x label ALA018
KABW105-020	20 metres 105 °C BlazeWire, 3x Electrical Splice connector AES3550-2, 3x Heat Shrink AHS001, End-of-line Resistor AER001, P-clamp APC014, 80x Cable Ties ACT314 and 8x label ALA018

Table 29: Heavy duty BlazeWire kits

Part No	Content
KABW185-005-HD	5 metres 185 °C BlazeWire, 3x Electrical Splice connectors AES3550-2, 3x Heat Shrink AHS001, End-of-line Resistor AER001 with P-clamp APC014, 10x silicone grommets AGBW003 with P-clamps APC020 and 2x label ALA018
KABW185-010-HD	10 metres 185 °C BlazeWire, 3x Electrical Splice connectors AES3550-2, 3x Heat Shrink AHS001, End-of-line Resistor AER001 with P-clamp APC014, 20x silicone grommets AGBW003 with P-clamps APC020 and 4x label ALA018
KABW185-015-HD	15 metres 185 °C BlazeWire, 3x Electrical Splice connectors AES3550-2, 3x Heat Shrink AHS001, End-of-line Resistor AER001 with P-clamp APC014, 30x silicone grommets AGBW003 with P-clamps APC020 and 6x label ALA018
KABW185-020-HD	20 metres 185 °C BlazeWire, 3x Electrical Splice connectors AES3550-2, 3x Heat Shrink AHS001, End-of-line Resistor AER001 with P-clamp APC014, 40x silicone grommets AGBW003 with P-clamps APC020 and 8x label ALA018
KABW105-005-HD	5 metres 105 °C BlazeWire, 3x Electrical Splice connectors AES3550-2, 3x Heat Shrink AHS001, End-of-line Resistor AER001 with P-clamp APC014, 10x silicone grommets AGBW003 with P-clamps APC020 and 2x label ALA018
KABW105-010-HD	10 metres 105 °C BlazeWire, 3x Electrical Splice connectors AES3550-2, 3x Heat Shrink AHS001, End-of-line Resistor AER001 with P-clamp APC014, 20x silicone grommets AGBW003 with P-clamps APC020 and 4x label ALA018
KABW105-015-HD	15 metres 105 °C BlazeWire, 3x Electrical Splice connectors AES3550-2, 3x Heat Shrink AHS001, End-of-line Resistor AER001 with P-clamp APC014, 30x silicone grommets AGBW003 with P-clamps APC020 and 6x label ALA018
KABW105-020-HD	20 metres 105 °C BlazeWire, 3x Electrical Splice connectors AES3550-2, 3x Heat Shrink AHS001, End-of-line Resistor AER001 with P-clamp APC014, 40x silicone grommets AGBW003 with P-clamps APC020 and 8x label ALA018



BlazeWire Standard Kit



BlazeWire Heavy Duty Kit

4.8 FASTENING MATERIAL

Linear parts of The BlazeCut system (BlazeTube detection, hoses, tubes, cables, LHD BlazeWire) must be tightly fastened and secured against movement. Use enclosed connecting material if necessary. It is possible to use other suitable fastening systems if they provide secure mounting of the components and are suitable for the environment (high temperatures etc.). Avoid damaging the components when fastening. Follow the instructions in this manual when fastening.

4.8.1 P-CLAMPS AND FASTENERS

BlazeCut system kits are supplied with various P-clamps suitable for firm fastening of the BlazeCut components.

Table 30: P-clamps

Part No	Description	Material
APC006	6 mm – suits 6 mm BlazeTube detection	galvanized steel, rubber insert
APC008	8 mm – suits LOP hose G1/4" ALH050-G14 - ALH500-G14	galvanized steel, rubber insert
APC010	10 mm – suits spiral ABTS006 and 1/4" Red Fire Hose ARFH04	galvanized steel, rubber insert
APC012	12 mm – all BlazeTube push-in connectors and 1/4" Red Fire Hose ARFH04 sleeve with fitting	galvanized steel, rubber insert
APC014	14 mm – suits end of line plug FBT1P6, end-of-line resistor AER001, end-of-line adapters AEA006	galvanized steel, rubber insert
APC016	16 mm – crimped sleeve LOP hose G1/4" ALH050-G14 - ALH500-G14	galvanized steel, rubber insert
APC018	18 mm – suits feed hose crimped sleeve AFH050-M22 - AFH500-M22, 1/2" Red Fire Hose ARFH08	galvanized steel, rubber insert
APC020	20 mm – suits 1/2" Red Fire Hose ARFH08 sleeve with fitting, grommets	stainless steel, PVC cover

Table 31: Through panel fasteners

Part No	Description	Material
ACG112	cable gland with locknut, for detection tube, 12 mm steel tube and electrical cable, 18.5 mm hole for mounting	polyamide



P-clamp APC006 - APC018



P-clamp AHC020



Cable gland ACG112

4.8.2 PROTECTIVE SPIRALS AND BRAIDS FOR THE BLAZETUBE DETECTION

In case of installation in the engine compartment or other enclosures with increased risk of mechanical damage the BlazeTube detection must be installed in the protective spiral or braid. Slot the BlazeTube detection into the protective spiral or braid before installation.



Do not use the protective braid on the BlazeTube detection in the main fire risk area as it could affect activation time of the BlazeTube detection.

IMPORTANT!

Always ensure the cut ends of spiral do not turn inward towards the BlazeTube, this will avoid scratches and damage to the BlazeTube.

Table 32: Types of protective spirals and braids

Part No	Description	Material	Length
ABTS006-005	protective spiral for \varnothing 6 mm BlazeTube detection	stainless steel	5 m
ABTS006-010	protective spiral for \varnothing 6 mm BlazeTube detection	stainless steel	10 m
ABTB006-005	protective braid for \varnothing 6 mm BlazeTube, from -55 °C to 180 °C	polyamide	5 m
ABTB006-010		polyamide	10 m



Protective spiral



Protective spiral with BlazeTube



Protective spiral kit



Protective braid

Table 33: Protective spiral kits

Part No	Description
KABTS006-005	for \varnothing 6 mm BlazeTube, 5 metres protective spiral ABTS006, 10 P-clamps APC010
KABTS006-010	for \varnothing 6 mm BlazeTube, 10 metres protective spiral ABTS006, 20 P-clamps APC010

4.8.3 BLAZE WIRE AND BLAZETUBE GROMMETS

For installation of the BlazeWire and BlazeTube (ABT170 only) in harsh environments use silicone grommets and plastic-coated P-clamps APC020. Maximum recommended distance between the clamps is 500 mm. When ordering the heavy duty BlazeWire and BlazeTube kits, the clamps and silicone grommets are included.

Table 34: Types of grommets

Part No	Description	Material
AGBW003	3 mm hole – suits BlazeWire	silicone
AGBT005	5 mm hole – suits BlazeTube	silicone



ABW185 BlazeWire in the P-clamp APC020 and grommet AGBW003



ABT170 BlazeTube in the P-clamp APC020 and grommet AGBT005

Table 35: Tube clamps

Part No	Description
ATC015	Ø 12 - 16 mm – suits Ø 12 steel tubes
ASC236	block clamp polyamide, zinc plated, 12 mm – suits Ø 12mm tube
ASC264-SS	block clamp polyamide, stainless steel with bolting flaps, 12 mm – suits Ø 12 mm tube



Tube clamp ATC015



Block clamp ASC236



Block clamp ASC264-S

Two lengths of high temp cable ties are available for fastening of cables and BlazeTube in fixed installations.

Table 36: Cable ties

Part No	Description
ACT314	heat resistance up to +125°C, 3.6 x 140 mm, black colour
ACT528	heat resistance up to +125°C, 5 x 280 mm, black colour



Never use cable ties for installation of BlazeTube in engine compartment or other installations with high ambient temperature. Always use suitable P-clamps.

4.9 LABELS

Various high-quality UV stabilized labels are supplied with the BlazeCut system to ensure that the operator or people that may come in contact with the system are informed about its presence and operation. All labels can be reordered separately when replacement is required due to damage.

Table 37: Notification labels

Part No	Description	Comment
ALA001	General Warning 150 x 100 mm	To notify there is a fire suppression system.
ALA002	"Shutdown Equipment" 100 x 70 mm	Label placed in the cabin near the alarm panel to notify the operator about delay time set to shut down equipment. Includes peel-off numbers that are placed on label in accordance with delay time set on the panel.
ALA003	"Delay discharge" 100 x 70 mm	Label placed in the protected area to notify the operator or personnel about delay time set to discharge the system. Includes peel-off numbers that are placed on label in accordance with delay time set on the panel.
ALA004	"In the event of a fire" 100 x 70 mm	Vehicle system label placed in the cabin to notify the operator about procedure in the event of a fire.
ALA005	"In the event of a fire" 100 x 70 mm	system label (fixed installation) placed in the protected area to notify the operator or personnel about procedure in the event of a fire.
ALA006	"Actuation arrow" 200 x 90 mm	Reflective label to highlight location of remote manual actuator.
ALA007	"Manual Actuator" 100 x 70 mm	Label placed next to remote actuators to notify the operator or personnel how to manually actuate the system in the event of a fire.

AUTOMATIC FIRE SUPPRESSION SYSTEMS



ALA017	"E9 107R-081633" 56 x 24 mm	Label "E9 107R-081633" approval mark on cylinder
ALA018	"Caution fire detection" 135 x 25 mm	Label for BlazeTube and BlazeWire
ALA019	"Fire alarm" ∅ 53 mm	Label for Buzzer fire alarm
ALA036	Cylinder service record	service label for the system, interior use only
ABS110	"BlazeCut" 110 x 68 mm	promotional sticker
ABS220	"BlazeCut" 220 x 135 mm	promotional sticker
ABS300	"BlazeCut" 300 x 110 mm	promotional sticker AFSS



General warning label ALA001



ALA002



ALA003



ALA004



ALA005



ALA006



ALA007



ALA017



ALA018



ALA019

AUTOMATIC FIRE SUPPRESSION SYSTEMS



ABS110 and ABS220



AUTOMATIC FIRE SUPPRESSION SYSTEMS
www.blazecut.com

ABS300

Cylinder service record				
Do not alter or modify the installation without reference to the authorised installer or manufacturer!				
System kit:				
Installation date:				
Date and type of service				
Date	Code	Comment	Next service due	Signature
Codes		Certified servicing body		
C - commissioned		place for distributor/installer label 120x25 mm		
A - annual service				
U - unscheduled service				
R - refill of agent				

ALA036

Table 38: Labels for cylinders

Part No	Agent	Cylinder size
ALA023	ABC Powder	2.4 L
ALA024	ABC Powder	2.4 L, 5.0 L, 7.8 L
ALA025	ABC Powder	13 L, 16 L

BLAZECUT FIRE SUPPRESSION SYSTEM

POWDER AGENT

POWDER AGENT 1354

Contact
+61 2 8058 1300
technical@blazecut.com
www.blazecut.com

Global Head Office
BlazeCut Pty Ltd
45 Evans Street
Balmain, NSW 2041, Australia

Manufacturer
BlazeCut s.p.a.
Piazzale della ZE21
90027 Borneolucio, Sicilia

Technical Specification
 Type of agent: ABC Powder
 Allowed operation temperature: -30°C up to +60°C
 Operation pressure at 20°C: 17 bar
 Charged with: Nitrogen (N₂)

Instructions for installation, maintenance and inspection
 • The system may be installed, maintained and inspected by persons trained or authorised by BlazeCut.
 • Installation, maintenance and inspection must be performed in accordance with instructions in the BlazeCut Installation and Service Manuals.
 • Inspection of the system must be performed at least once in 12 months.
 • Inspection of the system condition must be performed according to local legislation and respiratory requirements.
 • Install and maintain the system with BlazeCut components. The use of components not approved by the manufacturer will void the warranty, and may cause malfunction of the system, threatening the safety and health of people.

WARNING
 • The system is under constant pressure; any mechanical interference is prohibited.
 • Interference with the system may cause malfunction of the system and presents danger to safety and health of people.
 • Do not use this system as a portable fire extinguisher! It can present danger to the safety and health of people.
 • Contains gas under pressure; may explode if heated.

Attention
 Always consult suitability of use of the system and type of extinguishing agent in specific conditions with the manufacturer.

Cylinder labels identifying type of extinguishing agent and basic information and instructions about the system.

5 DEFINITION OF LEGAL REQUIREMENTS



BlazeCut system – cylinder, valve and BlazeTube detection form a pressure configuration. It forms a system that is under constant pressure, after the system is installed. Installation of the pressure configuration of the system, its activation and inspection, maintenance and operation is governed by specific legislation and these activities may only be performed by persons with relevant professional qualification subject to applicable legislation. Activation and operation of the equipment under pressure is also governed by specific legislation and professional inspections and tests.



Always observe local legislation and statutory requirements.

6 INFORMATION ON EXTINGUISHING AGENT USED

The BlazeCut systems CPO use dry ABC powder extinguishing agent based on ammonium salts. Please refer to SDS for detail information.

6.1 DESCRIPTION

The fire suppression is based on solid extinguishing agent (powder) acting in space applied into the flame. Each particle of the fire which enters the combustion reaction must have so called activation energy. If the particle of the fire hits the powder particle, its activation energy decreases and it will not enter the combustion reaction – the combustion is interrupted. The extinguishing agent must be applied directly onto the source of fire or the combustion focal point. Extinguishing agent does not contain dangerous materials, is not toxic or poisonous, it does not have carcinogenic or mutagenic effects.

Table 39: Extinguishing agent parameters

Agent	Chemical formula	Colour	Melting point	Density at 20 °C
ABC powder	NH ₄ H ₂ PO ₄	white	>200 °C	1.8 g/cm ³

6.1.1 MAIN ADVANTAGES OF THE EXTINGUISHING AGENT

- universal
- electrically non-conductive
- non-corrosive in dry conditions
- resistant to temperature changes
- safe for people

6.2 PERMISSIBLE USES OF THE EXTINGUISHING AGENT

ABC Powder may be used for the following classes of fire:



Class A – flammable combustibles (creating flames)



Class B – flammable liquids



Class C – flammable gaseous substances



*System is suitable for fire suppression of electrical equipment under voltage**

*Before dry chemical extinguishing equipment is considered for use in protecting electrical equipment or delicate electric relays, the effect of residual deposits of dry chemical on the performance on electrical equipment shall be evaluated. Always consult suitability of use of the system and type of extinguishing agent in specific conditions with the supplier.

6.3 IMPROPER USES OF EXTINGUISHING AGENT

Extinguishing agent is not suitable for fire suppression in spaces with:

- chemicals containing their own oxygen supply, such as cellulose nitrate;
- alkali metals, alkaline earth metals and metals in powder form (e.g., sodium, magnesium, aluminium, zinc, lithium etc.). The metals are not normally found in these forms. If the metals are found in compact, commonly used form the use of BlazeCut system is not limited;
- deep-seated or burrowing fires in ordinary combustibles where the dry chemical cannot reach the point of combustion;
- machinery such as carding equipment in textile operations and delicate electrical equipment.

If people are present always consult the use of the system in the specific area with the supplier.

6.4 WARNINGS



During the system activation the extinguishing agent emerges from nozzles under high pressure. It is recommended that the automatic activation function of the system is isolated when working in the protected area.



No permanent workplace should be placed within the area covered by the system. The system should not be installed allowing the extinguishing agent being discharged onto the people. Fire extinguishing powders can irritate the eyes, skin and throat and should be washed off skin as soon as possible.



For installation, inspection, maintenance and repair of the system always use eye protection – wear appropriate protective glasses with side-shields and appropriate protective impervious working gloves.

7 INSTRUCTIONS FOR INSTALLATION OF THE SYSTEM

7.1 INSTALLATION AND PLACEMENT OF THE CYLINDER

In order to release the extinguishing agent by pressure, there is a dip tube in the cylinder. This is why the cylinder is recommended to be installed in vertical position. If the cylinder is leaning, the extinguishing agent may not be fully released, the greater the mounted angle of the cylinder the higher risk of the agent not discharging entirely. Maximum recommended tilt of the cylinder is 45° from vertical axis.

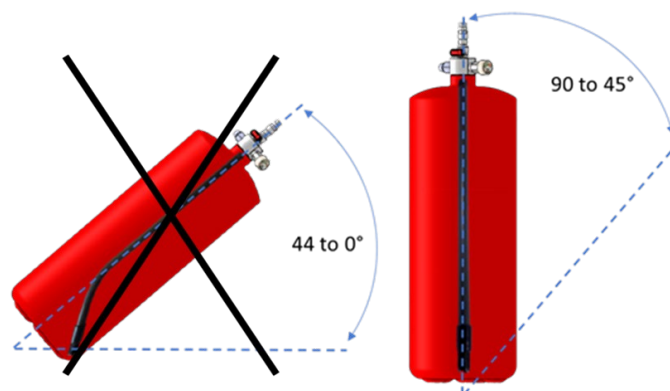

If the installation of the cylinder cannot be in a vertical position due to the design of the protected equipment, contact the supplier of the system before the purchase. A customised dip tube may be the solution and supplied at the time of filling the system by the manufacturer.

The cylinder should be placed as close to the protected area as possible, so that the length of the agent distribution network and detection lines can be as short as possible. If the cylinder is placed directly into the protected area, the cylinder should be protected from elevated temperatures or potential damage if necessary.

AUTOMATIC FIRE SUPPRESSION SYSTEMS



The cylinder should be placed so that the cylinder label is visible and the current pressure can be read on the pressure gauge and be readily accessible to allow future servicing or inspection.

Only install undamaged cylinders that are properly labelled and with the correct mounted cylinder valve. The cylinder is supplied pressurised to required pressure at the time of filling. The current pressure can be determined by reading the value on the pressure gauge, which is mounted on the cylinder valve when the system is supplied.



Do not install the cylinder, if the pressure is significantly different from values stated on the cylinder label or stated in this manual.

Carefully select a firm and secure part of the equipment to install the cylinder bracket using appropriate fasteners. If necessary, fabricate additional support to mount the cylinder. The cylinder must be properly fastened in the bracket using the bracket straps supplied. Once installed ensure all fastenings are firm and have no risk of loosening.

When installed in a vehicle, if the cylinder is situated in a horizontal position the valve must not be situated in a driving direction. Situate the bracket of the cylinder in a position so the cylinder will not eject from the bracket during a crash.

BlazeCut fire suppression systems are supplied with light brackets as standard for fixed and mobile applications except places in harsh environments (high vibrations, corrosive environment, higher risk of damage etc) where heavy duty brackets are required.



Light bracket ACB3xx



Heavy duty bracket ACB1xx

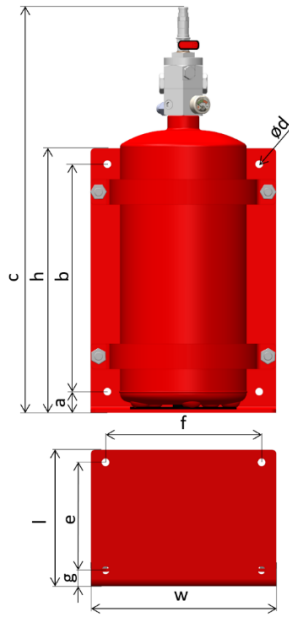

Cylinder with 20x valve in a heavy-duty bracket

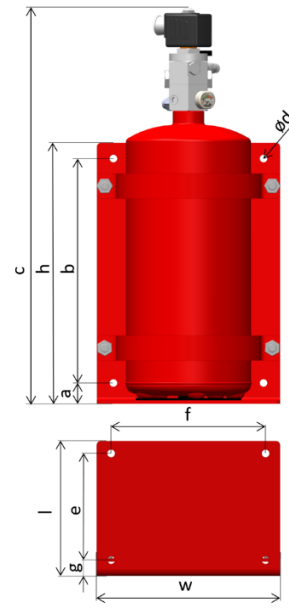

Cylinder with 21x valve in a heavy-duty bracket

Table 40: Brackets

Part №	l × w × h [mm]	a [mm]	b [mm]	Ø d [mm]	e [mm]	f [mm]	g [mm]	Material	Colour	Operating temperature
ACB124	122×165×294	23	242	9	83	130	22	powder coated steel	red RAL3000	-40 to +80 °C
ACB150	162×220×314	25	270	9	123	180	22			
ACB113	182×250×504	30	445	9	143	210	22			
ACB324	135×80×294	24.5	249.5	9	112	62	14			
ACB350	185×100×314	26	268	9	154	82	19			
ACB313	214×125×505	34.5	450	9	181	107	21			

Table 41: Cylinder assembly dimensions and weights (cylinder with valve fitted in a bracket)

Cylinder volume [L]	Bracket	Valve type	Total height c [mm]	Total weight [kg]*
1.2	ACB012	201, 202, 203	380	2.42
		207	334	2.43
		211, 212	376	2.71
2.4	ACB124	201, 202, 203	455	5.19
		207	409	5.19
		211, 212	451	5.47
5.0	ACB150	201, 202, 203	483	7.43
		207	437	7.43
		211, 212	479	7.72
7.8	ACB150	201, 202, 203	595	8.31
		207	549	8.31
		211, 212	591	8.60
13.0	ACB113	201, 202, 203	668	12.16
		207	622	12.17
		211, 212	664	12.45
16.0	ACB113	201, 202, 203	780	14.22
		207	734	14.22
		211, 212	776	14.50
2.4	ACB324	201, 202, 203, 207	455	3.76
		207	409	3.77
		211, 212	451	4.05
5.0	ACB350	201, 202, 203	483	4.66
		207	437	4.67
		211, 212	479	4.95
7.8	ACB350	201, 202, 203	595	5.56
		207	549	5.57
		211, 212	591	5.85
13.0	ACB313	201, 202, 203	668	7.47
		207	622	7.47
		211, 212	664	7.75
16.0	ACB313	201, 202, 203	780	9.47
		207	734	9.48
		211, 212	776	9.76

*all weights do not include extinguishing agent.

When placing the cylinder, leave free area around the cylinder valve of minimum 150 mm on the sides and minimum 100 mm above the valve, to install other components of the system and perform maintenance of the system in future.

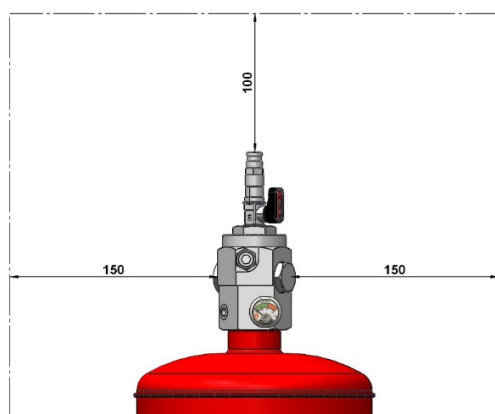

Example with the valve 201

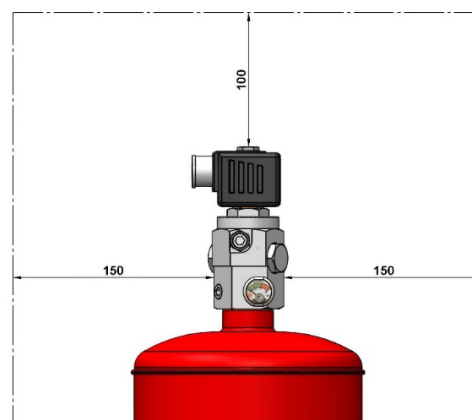

Example with the valve 211



7.2 MULTIPLE CYLINDERS CONNECTION

The BlazeCut system can have multiple cylinders connected to each other to protect larger spaces.

The method of functioning and activation of the system are the same when multiple cylinders are connected simultaneously. The BlazeTube detection must be connected to all the cylinder valves so that when the pressure in it decreases, all the valve pistons on all the cylinders are opened simultaneously.

7.2.1 INSTALLATION

In case of simultaneous connection of multiple cylinders, the extinguishing agent in all cylinders must be the same and all cylinders must be under the same pressure before installation.

The amount of extinguishing agent in each cylinder is indicated on the label of each cylinder, the total amount of the extinguishing agent in the system kit is the sum of the quantities of extinguishing agent in individual cylinders. The cylinders are connected into one pressurised unit after installation of the system, the pressure in all cylinders at steady state is always equal.

When multiple cylinders are connected it is possible to combine systems. If an electronic detection or activation is required, the master cylinder valve will be a 21x series valve with solenoid and is connected to multiple 20x series valves. If a pneumatic detection or activation is preferred, the master cylinder valve will be a 20x series valve, which is connected to multiple 20x series valves. In order to simultaneously release the extinguishing agent, all the cylinders must connect to the master cylinder valve which is connected to one detection circuit.

Table 42: BlazeTube installation limits in single and multiple cylinders configurations

Number of cylinders	Valve type combinations	Maximum length of BlazeTube [m]
Single cylinder	20x	40
	211	40
	212	40
Multiple cylinders: Electronic actuation and BlazeTube in protected enclosure	211/212 + 20x	15
	211/212 + 20x + 20x	15
	211/212 + 20x + 20x + 20x	10
	211/212 + 20x + 20x + 20x + 20x	10
	211/212 + 20x + 20x + 20x + 20x + 211/212	10
Multiple cylinders: LOP actuation with BlazeTube in protected enclosure	20x + 20x	40
	20x + 20x + 20x	40 in a loop
	20x + 20x + 20x + 20x	40 in a loop
	20x + 20x + 20x + 20x + 20x	40 in a loop
	20x + 20x + 20x + 20x + 20x + 20x	40 in a loop

IMPORTANT!

Maximum multiple cylinders configuration using the solenoid require two 211 or 212 series valves situated as first and last valve in the multiple cylinders configuration.

7.2.2 DISTRIBUTION NETWORK

If multiple cylinders are connected, the distribution tubes must be connected to each cylinder by using at least one outlet on each valve. In order to secure a fast discharge of the agent, it is necessary to use separate distribution circuits from each cylinder.



Never connect distribution lines from several cylinders into one distribution circuit as this will restrict the flow rate, extend the discharge time and reduce the performance of the system.

When multiple cylinders are connected, the cylinders must be placed at the same level and the lines must be installed as symmetric as possible. This will ensure an even and full discharge of agent from each cylinder.

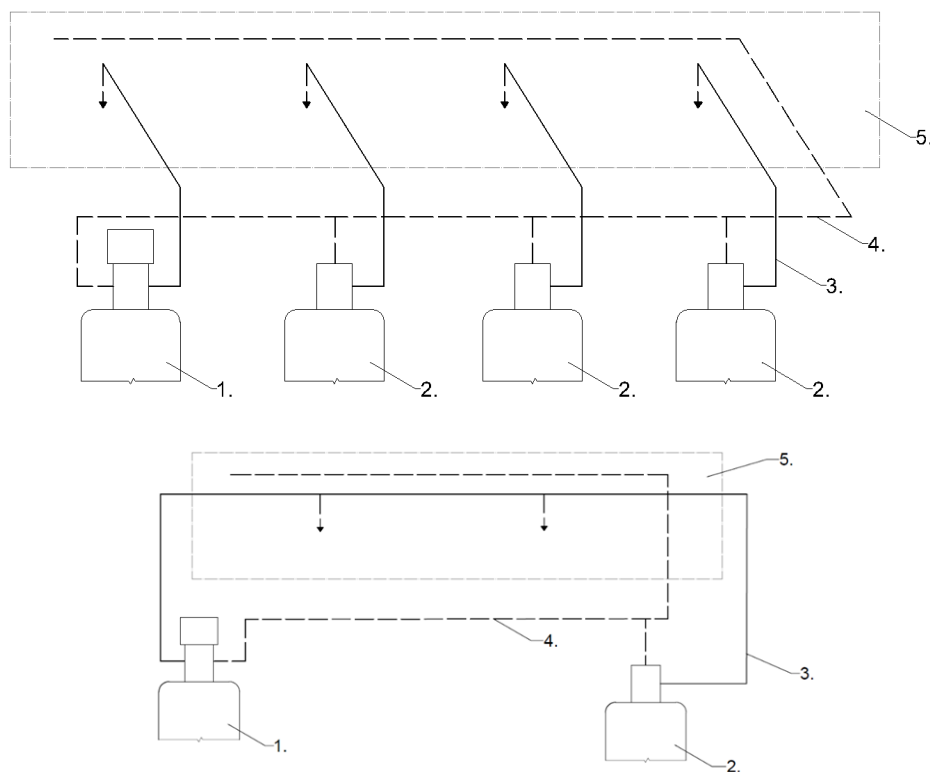

Recommended configurations of multiple cylinders connection

Electronic activation of the system requires a 21x series valve for actuation. If pneumatic actuation all valves are 20x series valves.

1. Cylinder with the pneumatic valves, 20x series.
2. Distribution network
3. BlazeTube detection
4. Protected enclosure

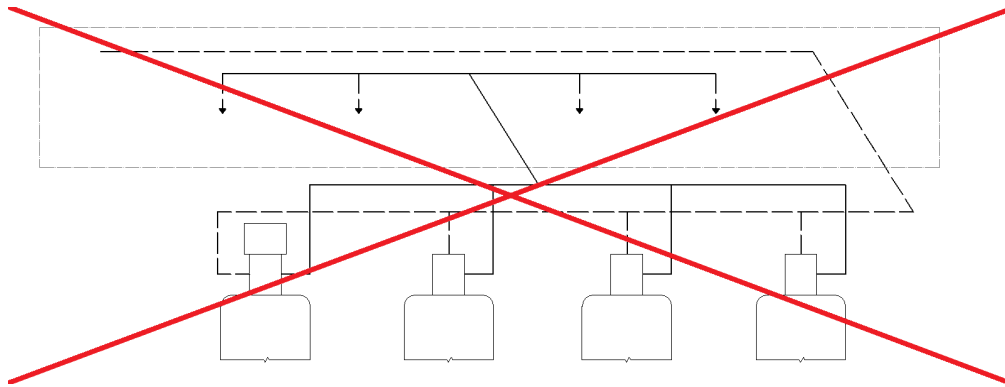

Not recommended configuration of multiple cylinders in joint distribution tubes

7.2.3 BLAZETUBE IN MULTIPLE CYLINDERS CONNECTION

BlazeTube connection in multiple cylinders is used:

- for a fire detection and also to connect the cylinders to secure simultaneous discharge of all cylinders,
- only to connect the cylinders to secure simultaneous discharge of all cylinders e.g., in installations using an electronic detection (BlazeWire, detector).

If the BlazeTube is used also for detection any part of this manual related to installation and pressurisation of the BlazeTube detection applies also to multiple cylinder connection.



Multiple cylinders connection of two 203 and one 202 series valves with BlazeTube used for both detection and connection of the cylinders

In installations where the BlazeTube is used only to connect the valves, the BlazeTube is not pressurised through the end-of-line device but from the master cylinder. Once the BlazeTube is installed slowly open ball valves on all cylinders one by one, starting closest to the master cylinder. This is to pressurise the BlazeTube and connect all cylinders into one pressurised unit. Once pressurised the discharge plugs can be removed and the discharge lines can be connected.



Multiple cylinders connection of one 211 or 212, 203 and 202 series valves with BlazeTube used only for connection of the cylinders

NOTE

When using *BlazeTube* for connection of valves make sure the length of *BlazeTube* is as symmetric as possible to secure simultaneous opening of all pistons in the cylinder valves.

7.2.4 PRESSURE MONITORING

Only one Pressure Switch APS001-xx, APS003-xx or one Pressure Transducer ATA100 is required when having a multiple cylinder connection. The pressure device can connect to one of the valves after completing the installation and the cylinder valves are connected into one pressurised unit (see Chapter [A2.4](#)).

7.3 INSTALLATION OF DISTRIBUTION NETWORK



Use only original components in distribution networks. Do not extend the network with unoriginal components. Do not use unoriginal hoses, tubes, fittings and nozzles.

7.3.1 FEED HOSES

Feed hose is used as follows:

- from discharge outlet connector to first fitting connecting rigid tube in order to secure maximum flow rate and fast discharge;
- in between the nozzles if it is not possible to use a rigid tube due to obstructions in enclosure (depending on size of the system);
- depending on type of installation, only one feed hose is used or if required two feed hoses from both discharge outlets can be used.

Table 43: Feed hoses

Part №	Length [cm]	Thread size	Material - outside	Operating temperature
AFH050-M22	50	M22x1.5	stainless steel wire braid	-40 to 230 °C
AFH075-M22	75			
AFH100-M22	100			
AFH200-M22	200			
AFH300-M22	300			
AFH400-M22	400			
AFH500-M22	500			



Feed hose

7.3.2 RED FIRE HOSES

Red Fire Hose is easy to assemble with straight or elbow reusable push-on couplings. Both size variants can be used as part of the agent distribution network combined with distribution tubes.

Table 44: Red Fire Hoses

Part №	Size	Inner diameter	Outside material	Inside material	Operating temperature	Length
ARFH08	1/2"	13 mm	NBR/PVC based	rubber with fibre braid reinforcement	-40 to 100 °C	per metre
ARFH04	1/4"	6 mm				

Cut of the Red Fire Hose

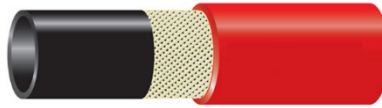

7.3.3 DISTRIBUTION TUBES

Steel tubes can be used in whole installation (fixed applications) or in part of installation where use of Red Fire Hoses is not possible e.g., due to high temperatures like in engine compartment above the turbo or exhaust manifold.

Table 45: Tubes

Part №	Outer diameter	Inner diameter	Length	Material
ATS012	12 mm	10 mm	1000 mm	stainless steel 304L/1.4307 Standard: EN10217-7
ATS015	15 mm	13 mm	1000 mm	stainless steel 304L/1.4307 Standard: EN10217-7



ATS012, ATS015

NOTE

The feed hoses and steel tubes use metric parallel thread fittings to connect between each other, so it is possible to combine hoses and tubes at any place using same fittings.

To achieve most effective use of BlazeCut system consult the type of hoses and tubes, method of creating the networks and their placement in the protected enclosure with the supplier of the system. In some cases, it may be necessary to add further components to the distribution networks (e.g., extension if the cylinder with extinguishing agent is located far from the protected enclosure). Consult specific cases with the supplier of the system.



To reduce the chance of contamination and an accidental discharge with the discharge circuit, the G3/8" valve plugs must remain mounted on the cylinder valve as supplied and only be removed after the detection circuit is connected and charged.

The distribution network includes all hoses, tubes and fittings installed, from the discharge port to the nozzles including. The network should be as short, straight and simple as possible to achieve sufficient pressure and maximum flow of the extinguishing agent through to the nozzles. Emptying the cylinder and achieving the required extinguishing concentration in the protected area should be as fast as possible. When designing the distribution hose/tubes it is appropriate to use as few connections and fittings as possible. Especially avoid of using too many elbows in the distribution networks. Narrowing of the diameter in network is possible only in the direction of the flow of the extinguishing agent. If possible, the hoses and tubes should be as symmetric as possible.

Other ways of streamlining the flow of extinguishing agent in the distribution hose/tubes, which can be used, if possible:

- Avoid changes of direction of the distribution networks in the vicinity of the fittings within the distance of 20 times the internal diameter of the tubes. Keep this distance between the fittings.

To ensure even distribution of the agent to both outlets in a Tee fitting, make sure that all the following conditions are met:

- inlet is perpendicular to both outlets, while both outlets lie in a horizontal plane
- at least minimum allowed distance between fittings is preserved
- both outlets are connected to the same diameter distribution hose or tube
- the distribution hoses or tubes are fitted with nozzles with equal flow rates
- bend tubes rather than use elbow fittings.

Not following these conditions can lead to significant disproportion of flow rates of over 60 %.

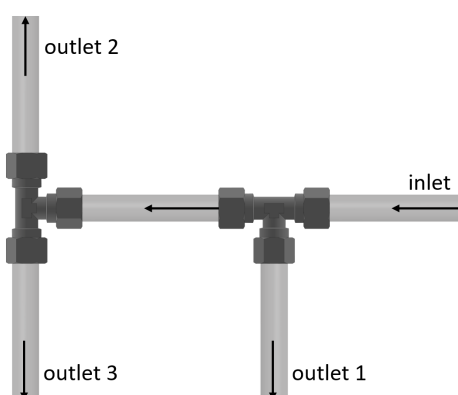
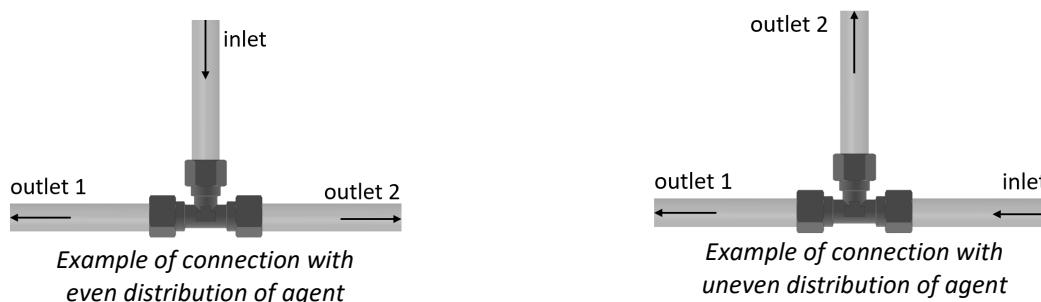

Even agent distribution for configurations with 3 nozzles on one outlet

NOTE

Tube lengths on the figure are not to scale.

Table 46: Bending radius

Type of hose or tube	Minimum bending radius [mm]
Feed hose	85
Red Fire Hose 1/4"	45
Red Fire Hose 1/2"	80
galvanized/stainless steel tube 12 mm	25
galvanized/stainless steel tube 15 mm	30



Do not forcibly bend the hoses and tubes below the minimum bending radius . This can cause damage and reduce the performance of the system.

Place the hoses/tubes through appropriate parts of the protected enclosure and gradually clamp with appropriate fastening material (see Chapter 4.8). Proper mounting of the hoses/tubes prevents them from rubbing and vibrating ensuring durability of the installed system. When the system is activated and extinguishing agent released, the hoses/tubes are exposed to the forces of pressure and flow of extinguishing agent. During the activation of the fire system the hoses/tubes must not be displaced, as it may change the desired flow and direction of extinguishing agent from the nozzles.



Always place clamps next to fittings connecting nozzles to make sure they will hold firmly in place at time of discharging the extinguishing agent.

Table 47: Maximum fastening distance

Type of hose/tube	Maximum fastening distance [mm]
Feed hose	500
Red Fire Hose 1/4"	350
Red Fire Hose 1/2"	350
galvanized/stainless steel tube 12 mm	750
galvanized/stainless steel tube 15 mm	750



Fasten hoses also in place of bending. Properly fasten the hoses just before the ending with the nozzle to prevent change to the flow direction of the extinguishing agent. When using the tube, the maximum distance between the last fastening and nozzle must not be more than 100 mm.







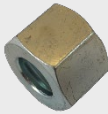

7.3.4 FITTINGS

Fittings for steel tubes are supplied in two versions:

1. SET: includes rings and nuts – suitable when connecting ATG012, ATS012 or ATS015 steel tubes
2. BODY: supplied without rings and nuts – suitable when connecting Red Fire Hose

Table 48: List of fittings used with a 12 mm tube (M18x1.5)

Picture	Part №	Description	Material
	FTFTN12U18	Tube nut for cutting ring for 12 mm tube (M18x1.5)	galvanized steel
	FTFCR12	Tube ring compressing for 12 mm tube	galvanized steel

	FTF1MM1818	Tube fitting straight coupling for 12 mm tube (M18x1.5) - BODY, Male-Male	galvanized steel
	FTF1MM1818-SET	Tube fitting straight coupling for 12 mm tube (M18x1.5) - SET (with rings and nuts), Male-Male	galvanized steel
	FRC1MM2218	Tube fitting straight reduced coupling Feed Hose (M22x1.5) to 12 mm tube (M18x1.5) - BODY, Male-Male	galvanized steel
	FRC1MM2218-SET	Tube fitting straight reduced coupling Feed Hose (M22x1.5) to 12 mm tube (M18x1.5) - SET (with rings and nuts), Male-Male	galvanized steel
	FTF2MM1818	Tube fitting elbow equal for 12 mm tube (M18x1.5) - BODY, Male-Male	galvanized steel
	FTF2MM1818-SET	Tube fitting elbow equal for 12 mm tube (M18x1.5) - SET (with rings and nuts), Male-Male	galvanized steel
	FTF2MU1818	Tube fitting elbow with rotary nut to nozzle connector for 12 mm tube (M18x1.5) - BODY, Male-Female	galvanized steel
	FTF2MU1818-SET	Tube fitting elbow with rotary nut to nozzle connector for 12 mm tube (M18x1.5) - SET (with rings and nuts), Male-Female	galvanized steel
	FTF3MMM181818	Tube fitting tee equal for 12 mm tube (M18x1.5) - BODY, Male-Male-Male	galvanized steel
	FTF3MMM181818-SET	Tube fitting tee equal for 12 mm tube (M18x1.5) - SET (with rings and nuts), Male-Male-Male	galvanized steel

	FTF3MUM181818	Tube fitting tee with rotary nut to nozzle connector for 12 mm tube (M18x1.5) - BODY, Male-Female-Male, galvanized steel	galvanized steel
	FTF3MUM181818-SET	Tube fitting tee with rotary nut to nozzle connector for 12 mm tube (M18x1.5) - SET (with rings and nuts), Male-Female-Male	galvanized steel
	FTF3MMU181818	Tube fitting tee with rotary nut to distribution hose for 12 mm tube (M18x1.5) - BODY, Male-Male-Female	galvanized steel
	FTF3MMU181818-SET	Tube fitting tee with rotary nut to distribution hose for 12 mm tube (M18x1.5) - SET (with rings and nuts), Male-Male-Female	galvanized steel
	FBH1MM1818	Tube fitting bulkhead for 12 mm tube (M18x1.5) - BODY, Male-Male	galvanized steel
	FBH1MM1818-SET	Tube fitting bulkhead for 12 mm tube (M18x1.5) - SET (with rings and nuts), Male-Male	galvanized steel

Table 49: List of nozzle fittings used with a 12 mm tube (M18x1.5)



Picture	Part №	Description	Material
	FNF1MB1808	Nozzle connector for 12 mm tube (M18x1.5) and nozzles ANP120, ANP160 (G1/2") - BODY, Male-Male	galvanized steel
	FNF1MB1808-SET	Nozzle connector for 12 mm tube (M18x1.5) and nozzles ANP120, ANP160 (G1/2") - SET, Male-Male	galvanized steel

Table 50: List of fittings used with 15 mm tube (M22x1.5)

Picture	Part №	Description	Material
	FTFTN15U22	Tube nut for cutting ring for 15 mm tube (M22x1.5)	galvanized steel

	FTFCR15	Tube ring compressing for 15 mm tube	galvanized steel
	FTF1MM2222	Tube fitting straight coupling for 15 mm tube (M22x1.5) - BODY, Male-Male	galvanized steel
	FTF1MM2222-SET	Tube fitting straight coupling for 15 mm tube (M22x1.5) - SET (with rings and nuts), Male-Male	galvanized steel
	FTF2MM2222	Tube fitting elbow equal for 15 mm tube (M22x1.5) - BODY, Male-Male	galvanized steel
	FTF2MM2222-SET	Tube fitting elbow equal for 15 mm tube (M22x1.5) - SET (with rings and nuts), Male-Male	galvanized steel
	FNF2MU2222	Tube fitting elbow with rotary nut for 15 mm tube (M22x1.5) and nozzle connector (M22x1.5) - BODY, Male-Female	galvanized steel
	FNF2MU2222-SET	Tube fitting elbow with rotary nut for 15 mm tube (M22x1.5) and nozzle connector (M22x1.5) - SET (with rings and nuts), Male-Female	galvanized steel
	FTF3MMM222222	Tube fitting tee equal for 15 mm tube (M22x1.5) - BODY, Male-Male-Male	galvanized steel
	FTF3MMM222222-SET	Tube fitting tee equal for 15 mm tube (M22x1.5) - SET (with rings and nuts), Male-Male-Male	galvanized steel
	FNF3MUM222222	Tube fitting tee with rotary nut for 15 mm tube (M22x1.5) and nozzle connector (M22x1.5) - BODY, Male-Female-Male	galvanized steel



	FNF3MUM222222-SET	Tube fitting tee with rotary nut for 15 mm tube (M22x1.5) and nozzle connector (M22x1.5) - SET (with rings and nuts), Male-Female-Male	galvanized steel
	FBH1MM2222	Tube fitting bulkhead for 15 mm tube (M22x1.5) - BODY, Male-Male	galvanized steel
	FBH1MM2222-SET	Tube fitting bulkhead for 15 mm tube (M22x1.5) - SET (with rings and nuts), Male-Male	galvanized steel

Table 51: List of nozzle fittings used with 15 mm tube (M22x1.5)







Picture	Part №	Description	Material
	FNF1MB2208	Nozzle connector for 15 mm tube (M22x1.5) and nozzles ANP120 or ANP160 (G1/2") - BODY, Male-Male	galvanized steel
	FNF1MB2208-SET	Nozzle connector for 15 mm tube (M22x1.5) and nozzles ANP120 or ANP160 (G1/2") - SET (with rings and nuts), Male-Male	galvanized steel

Table 52: List of fittings for Red Fire Hose (G1/4", G1/2" thread)

Picture	Part №	Description	Material
	FHF1CR0404	Hose fitting push on straight female swivel for 1/4" RF hose (G1/4"), Female-Push-on	galvanised steel
	FHF2CR0404	Hose fitting push on elbow female swivel for 1/4" RF hose (G1/4"), Female-Push-on	galvanised steel
	FHF1CR0808	Hose fitting push on straight female swivel for 1/2" RF hose (G1/2"), Female-Push-on	galvanised steel
	FHF2CR0808	Hose fitting push on elbow female swivel for 1/2" RF hose (G1/2"), Female-Push-on	galvanised steel

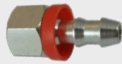
	FHF1BB0404	Hose fitting straight coupling for 1/4" RF hose (G1/4"), Male-Male	galvanised steel
	FRC1BC0408	Hose fitting reduced coupling swivel straight for 1/4" RF hose (G1/4") and fitting G1/2", Male-Female	galvanised steel
	FRC1BB0804	Hose fitting reduced coupling for 1/2" RF hose (G1/2") and 1/4" RF hose (G1/4"), Male-Male	galvanised steel
	FHF1BB0808	Hose fitting straight coupling for 1/2" RF hose (G1/2"), Male-Male	galvanised steel
	FRC1BM0818	Hose fitting reduced coupling for 1/2" RF hose (G1/2") and 12 mm tube (M18x1.5) - BODY, Male-Male	galvanised steel
	FRC1BM0818-SET	Hose fitting reduced coupling for 1/2" RF hose (G1/2") and 12 mm tube (M18x1.5) - SET, Male-Male	galvanised steel
	FRC1CM0818	Hose fitting reduced coupling for fitting G1/2" and 12 mm tube (M18x1.5) - Female-Male	galvanised steel
	FHF2BC0404	Hose fitting swivel nut elbow for 1/4" RF hose (G1/4"), Male-Female	galvanised steel
	FHF2BB0808	Hose fitting elbow equal for 1/2" RF hose (G1/2") - Male-Male	galvanized steel
	FHF2BC0808	Hose fitting swivel nut elbow for 1/2" RF hose (G1/2"), Male-Female	galvanised steel

	FHF4BC0808	Hose fitting swivel nut 45° for 1/2" RF hose (G1/2"), Male-Female	galvanised steel
	FHF3BCB040404	Hose fitting swivel nut tee for 1/4" RF hose (G1/4"), Male-Female-Male	galvanised steel
	FHF3BBB080808	Hose fitting equal tee for 1/2" RF hose (G1/2"), Male-Male-Male	galvanised steel
	FHF3CCC080808	Hose fitting swivel nut tee for 1/2" RF hose (G1/2"), Female-Female-Female	galvanised steel
	FHF3BCB080808	Hose fitting swivel nut tee for 1/2" RF hose (G1/2"), Male-Female-Male	galvanised steel
	FHF3BCC080808	Hose fitting swivel nut side tee for 1/2" RF hose (G1/2"), Male-Male-Female	galvanised steel
	FBH1BB0404	Hose bulkhead fitting straight for 1/4" RF hose (G1/4"), Male-Male	galvanised steel
	FBH1BB0808	Hose bulkhead fitting straight for 1/2" RF hose (G1/2"), Male-Male	galvanised steel

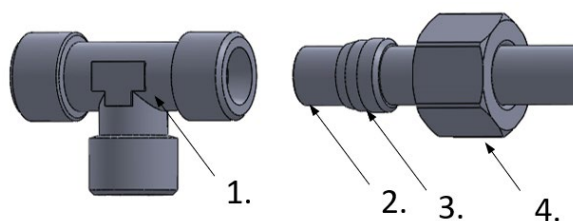

Connection of steel tube to a fitting

1. Tube Tee fitting FTF3MMM181818
2. Tube ATG012 or ATS012
3. Tube compressing ring fitting FTF3CR12
4. Tube compressing nut fitting FTFTN12U18

The red fire hose is connected by the use of push on fittings.

1. Measure and cut the hose using a hose cutter or a sharp knife.
2. When inserting the fitting into the hose use a light coating of soapy water or a light oil.
3. Place the fitting inside the hose. You will need to grip the hose approximately 25-50 mm (1-2 inches) from the end with the fitting inserted.
4. Press the push on fitting against a hard surface, or use a vice while holding the hose, until fully inserted and pushing hard against the red cap.



NOTE

Once assembled the hose and push on fittings are rated to very high pressures. There is no need to use additional hose clamps or cable ties to further secure the hose fitting.

7.3.5 NOZZLES

Powder nozzles are used for distribution and controlled spread of the extinguishing agent into the protected enclosure with a fire hazard. Powder nozzles secure predefined flow rate and flow profile of the agent.

Plan ahead where to place the extinguishing nozzles depending on all the hazards to be protected. The nozzles on the distribution networks must be placed inside the protected enclosure and be directed to the riskiest places of the enclosure pinpointed by hazard analysis.

Decision on selection of the appropriate nozzle should be dependent on the requirement to cover the whole fire hazard area. For maximum efficiency and protection, do not place the nozzles of the system behind barriers that could restrict or reduce the fire suppression effect by preventing direct penetration of extinguishing agent into the protected enclosure. Take into consideration that direction of airflow and distance between nozzle and fire hazard has influence on the covered area. Recommended positioning of the nozzles is above the fire hazard to 90° angle from the vertical axis, at the same time preserving minimal and maximal allocation distances between nozzle and fire hazard. Placing the nozzle in closer vicinity than recommended can lead to dispersion of flammable material to its surroundings while putting the nozzle farther away can reduce the fire suppression effectivity.

The distribution networks must always be ended by a nozzle. There may not be any free outlets in the distribution network e.g., connectors without nozzles.

Table 53: Types of powder nozzles

Part №	Thread size	Description	Material
ANP120	G1/2"	120° cone, 2 mm bores	stainless steel
ANP160		160° flat slot	



ANP120



ANP160

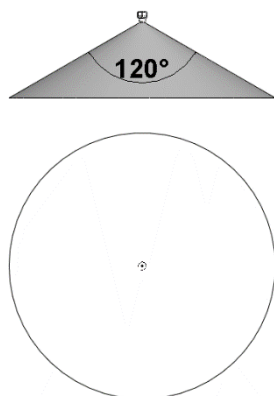

Discharge profile of ANP120 nozzle

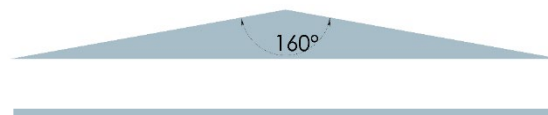

Discharge profile of ANP160 nozzle

Powder nozzle ANP120 has a conical discharge profile and is ideal for coverage of larger areas without direct obstacles e.g., top of the engine.

Powder nozzle ANP160 has a rectangular pyramid flow profile which is more concentrated and direct and is ideal for applications in limited spaces e.g., fuel or hydraulic lines concealed from the top. To fix the orientation of the nozzle flow profile in a desired position, use the ANN001 locking nut.

Powder nozzles ANP120 and ANP160 have equal flow rates if all other parts of the system are the same.

The combination of both ANP160 and ANP120 nozzles is allowed.

7.3.6 NOZZLE DUST CAPS

Nozzle dust caps are flexible protection caps that stop the ingress of unwanted debris or environmental contaminants.

Table 54: Nozzle dust cap

Part №	Length	Operating Temperature	Inside diameter	Material
ANC002	130 mm	-40 to +180 °C	17 mm	silicone, 50 duro



Nozzle dust cap

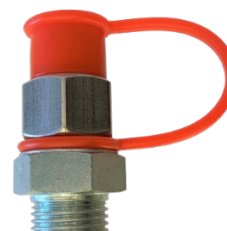

Nozzle with fitted dust cap

Table 55: Nozzle bracket

Part №	Assembly hole	Description	Material
ANB001	22 mm	for firm fixing of nozzle assembly or other components (remote actuator, EOL adapter)	stainless steel
ANN001	-	G1/2" locking nut for ANP160 fixture	galvanised steel
AWR001	M20	Flat washer for remote actuator and nozzle assembly	galvanized steel

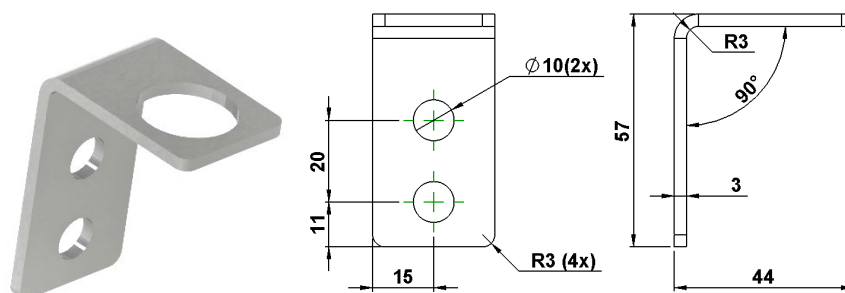

Nozzle bracket ANB001 dimensions

Table 56: Nozzle assemblies for mobile applications

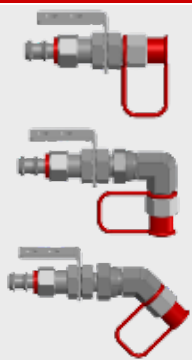
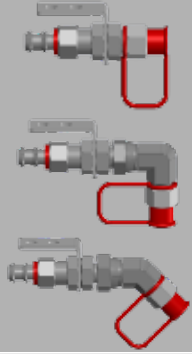
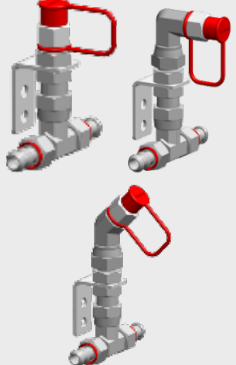
Part №	Picture	Description	Components
KNAP11-120		Nozzle Kit Assembly Powder 120° Cone Nozzle - End Of Line Type	1x FHF1CR0808 1x FBH1BB0808 1x FHF2BC0808 1x FHF4BC0808 1x ANP120 1x ANC002 1x ANB001 1x AWR001
KNAP11-160		Nozzle Kit Assembly Powder 160° Cone Nozzle - End Of Line Type	1x FHF1CR0808 1x FBH1BB0808 1x FHF2BC0808 1x FHF4BC0808 1x ANP160 1x ANC002 1x ANB001 1x AWR001
KNAP21-120		Nozzle Kit Assembly Powder 120° Cone Nozzle - T fitting In Line Type	2x FHF1CR0808 1x FBH1BB0808 1x FHF3BCB080808 1x FHF2BC0808 1x FHF4BC0808 1x ANP120 1x ANC002 1x ANB001 1x AWR001

KNAP21-160		Nozzle Kit Assembly Powder 160° Cone Nozzle - T fitting In Line Type	2x FHF1CR0808 1x FBH1BB0808 1x FHF3BCB080808 1x FHF2BC0808 1x FHF4BC0808 1x ANP160 1x ANC002 1x ANB001 1x AWR001
------------	--	---	--

7.4 INSTALLATION OF THE BLAZETUBE DETECTION

Table 57: Tool charging kit

Model	Included components
KATC001	1 x adjustable regulation valve (Standard W 24,32x1/14") 1 x Charging adapter ATC001 2 m BlazeTube, 6 mm 1 x BlazeTube cutter ATC002



Tool charging kit KATC001

The efficiency of BlazeCut system significantly depends on correct placement of the BlazeTube detection. Follow the instructions below. The BlazeTube must be placed so that it is disrupted as soon as the fire starts, before damaging other components of BlazeCut system and before the fire spreads outside of the protected enclosure. BlazeCut system uses quick slotting system of mounting BlazeTube detections in fittings with double seal to prevent leak of extinguishing agent and of pressure. Use only the fittings supplied with the system. Ends of the BlazeTube detection must be properly adjusted. End of the BlazeTube detection must be straight before inserting, without cuttings and notches to avoid damaging the seals in the connectors .

To cut the BlazeTube detection use special cutter ATC002 included in the Tool charging kit KATC001.

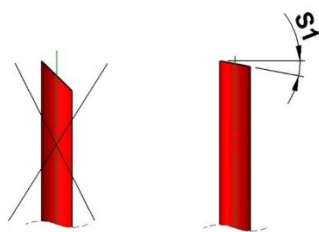

Example of incorrect (left) and correct (right) BlazeTube end cuts



BlazeTube cutter ATC002

Step 1. Cut the BlazeTube detection straight, maximum degree of chamfer is 5°

Fasten the BlazeTube detection firmly so that it is slotted into the BlazeTube outlet connector and pushed all the way by hand. After slotting always check if the BlazeTube is firmly fastened by gently pulling it. Do not open the ball valve on the BlazeTube outlet connector yet.

Step 1: Slot the BlazeTube detection firmly into the connector all the way

Step 2: Pull the BlazeTube detection slightly and make sure that it is firmly fastened

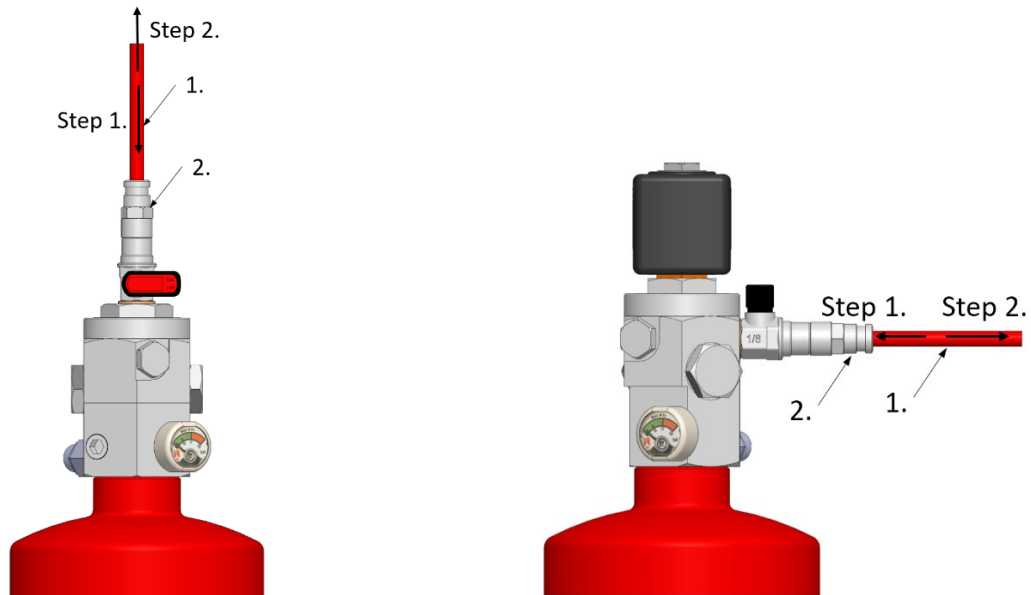

Scheme of connecting the BlazeTube detection to the fittings on the cylinder valve (example: valve 201 on the left, valve 211-30 on the right)

1. BlazeTube Detection
2. BlazeTube Detection outlet connector FBT1BP026

Always slot the BlazeTube detection to the outlet adapter all the way in.

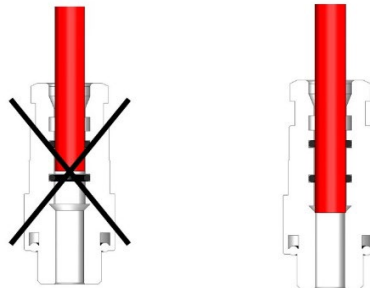

Detail of slotting the BlazeTube detection to the outlet connector



Do not open the ball valve before pressurising the BlazeTube detection! This may open the valve piston of the cylinder and extinguishing agent will be released. Protect the ball valve before accidental opening during transportation and handling of the cylinder. Follow the instructions for transportation of the cylinder.



During normal operation of the system, the pressure in the BlazeTube detection is the same as in the cylinder.

Disconnect the BlazeTube detection from a BlazeTube connector by pushing the connector's ring in (away from the BlazeTube detection) and pull the BlazeTube detection away from the BlazeTube connector. Proceed accordingly when disconnecting the BlazeTube detection from the end-of-line adapter.

Step 1: Push the ring of the BlazeTube detection outlet connector

Step 2: Pull the BlazeTube detection from the connector

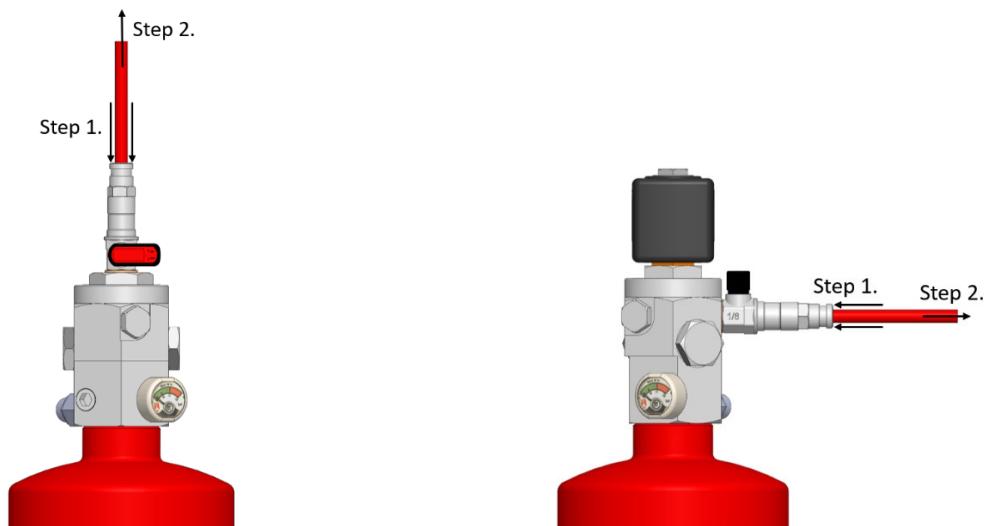

Disconnection of the BlazeTube detection from the valve
(example: valve 201 on the left, valve 211 or 212 on the right)



During disconnection of the BlazeTube detection under pressure, a pressure is released and if the system was in operation, also small amount of agent is released. In such case always wear appropriate protective glasses with side-shields and suitable protective gloves. Aim the BlazeTube detection always apart. Make sure not to interpose any other person.

If the BlazeTube detection is under pressure disconnection can be more difficult. The pressure can be released by pushing a small pin of the charging adapter inside the end-of-line device. Before this procedure, dismantle the pressure gauge and make sure that the ball valve is closed.

7.4.1 PROCEDURE OF INSTALLATION OF THE BLAZETUBE DETECTION IN A PROTECTED ENCLOSURE

Place the BlazeTube detection in the protected enclosure and gradually fasten it with P-clamps and fastening elements. Proper fastening of BlazeTube detection is important. In case of fire, it is exposed to fast changes in pressure and forces of flowing gas. Maximum distance between fastenings of the tube cannot be more than 250 mm. Fastening must also be in place where the tube bends. To preserve sufficient flexibility of the BlazeTube detection, it is recommended to install it at ambient temperature of more than 10 °C.

IMPORTANT!

The BlazeTube detection must come out of each connection in direct position in order to avoid any leakage. If a redirection of the BlazeTube detection is needed, the bend of the tube from the connection must be in a minimum distance of 50 mm.

Table 58: Boundary dimension values

Symbol	Value
A	max 1000 mm
L	max 250 mm
R	min 100 mm
max. number of bends per 1 m	3

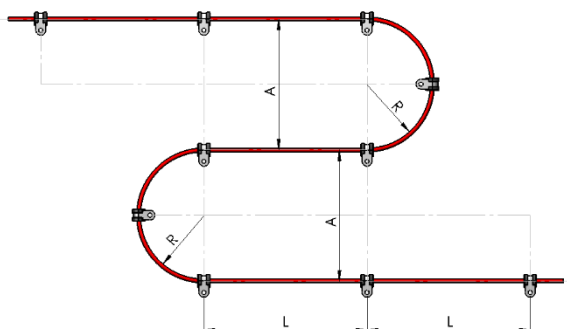

BlazeTube mounting

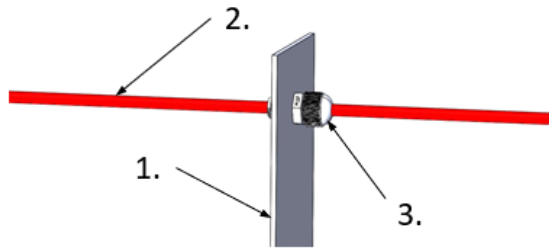

At the crossing of the BlazeTube through a structure it is advised to protect the BlazeTube.

1. structure
2. BlazeTube detection
3. protective element (cable gland ACG112, rubber grommet etc.)

Place the BlazeTube detection as close as possible above the places with greatest risk of fire. Do not place the tube horizontally next to places of possible fire, it may significantly delay activation of the system in case of fire.

The BlazeTube detection cannot be placed freely in the protected enclosure. It must be tightened to appropriate construction. If necessary, the BlazeTube detection can be installed in open space (e.g., above the protected device) by using steel wire, which is wired in suitable area of the protected enclosure and the BlazeTube detection can be tightened on a steel wire. Use a steel wire with appropriate strength and wire the steel wire firmly.

Proceed carefully during installation not to damage the BlazeTube with sharp objects. Do not refract or forcibly bend the BlazeTube.

During installation of the BlazeTube detection, specifically make sure that the tube will not be damaged during operation of the device by mechanical stress. After the system is fully installed and functional, if the BlazeTube is damaged, and the pressure decreases the system will always activate.

The tube cannot be in direct contact with hot parts of the protected device or in immediate proximity of parts of the device, which heat to high temperatures during operation (transformers etc.).

Depending on the size and shape of the protected enclosure use necessary length of the BlazeTube detection. If you do not use the whole tube, cut the ending; the ending must be adjusted, see figures at start of this chapter.

Place the loose ending of the BlazeTube detection into the area so that it is possible to pressurise the system using charging kit through end-of-line adapter of the tube, and also to enable in future to perform inspection of pressure in the system with pressure gauge on end-of-line adapter of the tube, if the pressure gauge will be installed at the end-of-line adapter.

Fasten the end-of-line adapter into the ending of the BlazeTube; proceed according to the figure below.

Step 1: BlazeTube detection properly slotted to the end-of-line adapter all the way

Step 2: After slotting always make sure that the BlazeTube is firmly fastened by gentle pulling it

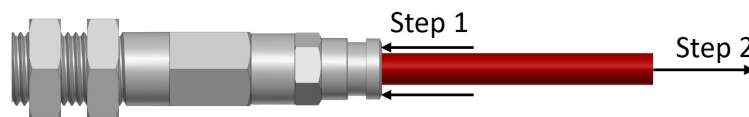

Connection of the BlazeTube detection on the end-of-line adapter

7.4.2 EXAMPLES OF INSTALLATION OF THE BLAZETUBE DETECTION

For maximum length of BlazeTube see [Table 42](#) in Chapter [7.2](#).

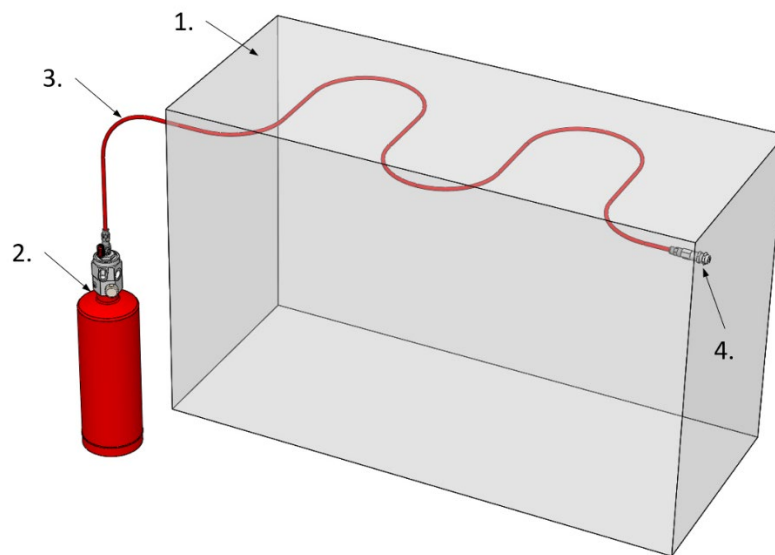

Simple installation with one cylinder

1. Protected enclosure
2. Cylinder with the valve
3. BlazeTube detection
4. End-of-line adapter or pneumatic actuator

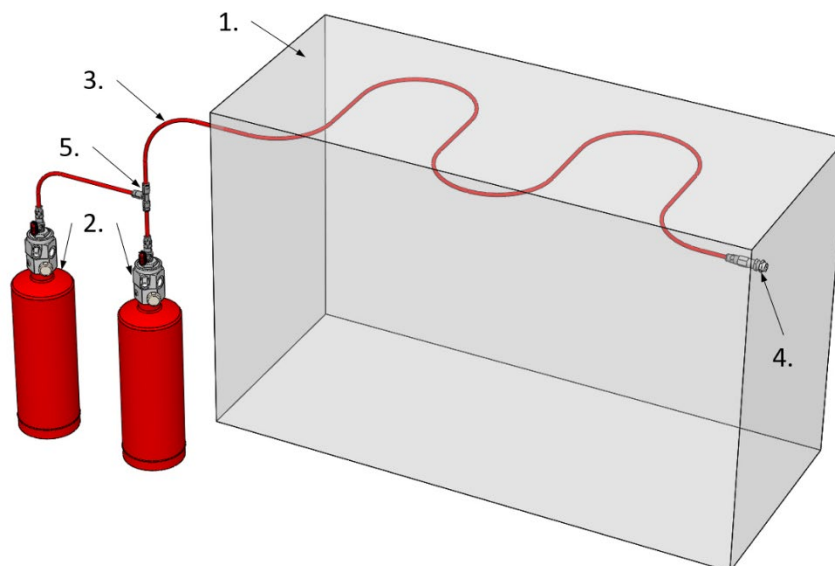

Simple installation of multiple cylinders. The BlazeTube detection must be connected to both cylinders by using a Tee connector.

1. Protected enclosure
2. Cylinder with the valve
3. BlazeTube detection
4. End-of-line adapter or pneumatic actuator
5. BlazeTube Tee connector

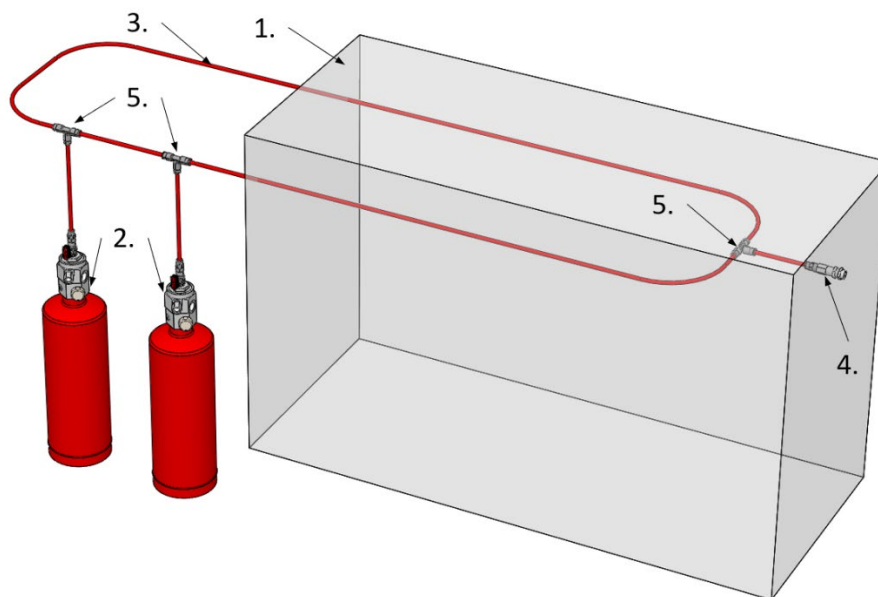

*Multiple cylinders installation with the BlazeTube detection in loop.
Recommended for applications where long BlazeTube detection is needed.*

1. Protected enclosure
2. Cylinder with the valve
3. BlazeTube detection
4. End-of-line adapter or pneumatic actuator
5. BlazeTube Tee connector

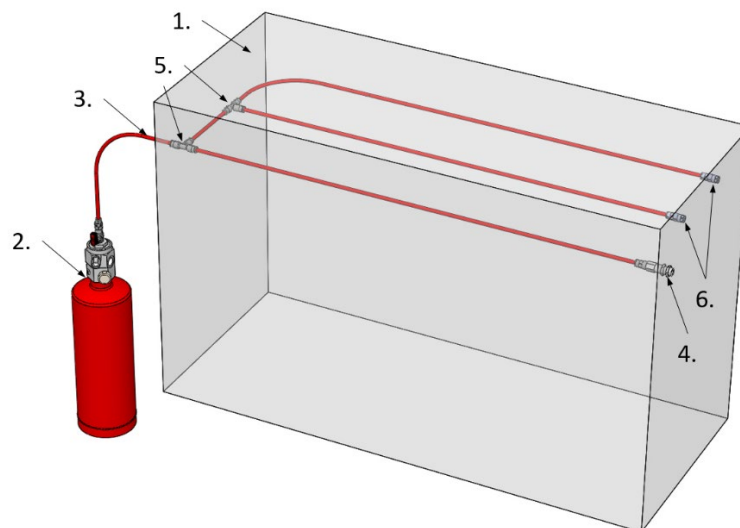

Installation with one cylinder, the BlazeTube detection is branched. This method reduces length of the BlazeTube detection. It is suitable for installations where large space has to be covered and the BlazeTube detection would have to be very long when using simple installation.

1. Protected enclosure
2. Cylinder with the valve
3. BlazeTube detection
4. End-of-line adapter or pneumatic actuator (one end-of-line device is sufficient for one installation)
5. Tee connection
6. End-of-line plug

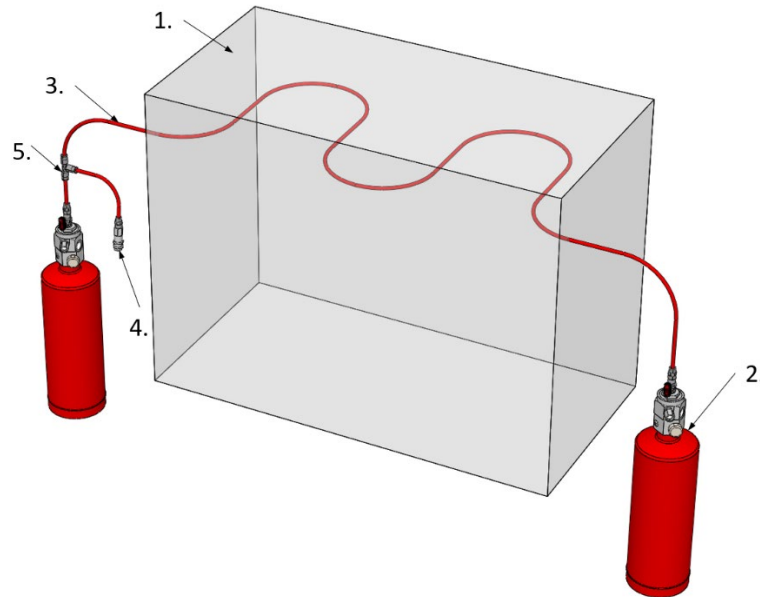

Cylinders are situated on opposite sides of the protected enclosure. This method is suitable when larger space needs to be protected, for example the protected enclosure is long (shafts etc.).

1. Cylinder with the valve
2. Protected enclosure
3. BlazeTube detection
4. End-of-line adapter or pneumatic actuator
5. BlazeTube Tee connector

7.4.3 GENERAL WARNINGS AND INSTRUCTIONS

Manual activation devices must always be installed in easily accessible places so that the person operating them would not be endangered by fire the operation of the system itself (see [ANNEX 3: PNEUMATIC REMOTE ACTUATORS ARA010 AND ARA020](#)).

Electronic activation of the system (using an electric actuator or an alarm panel) enables to place the devices for manual activation in greater distance from the protected area than activation using pneumatic remote actuators (see [ANNEX 4: ELECTRIC REMOTE ACTUATORS ARA110 AND ARA120](#)).

7.5 PRESSURISATION OF THE CYLINDER AND THE DETECTION SYSTEM

The cylinder and BlazeTube detection must be pressurised with the correct pressure by nitrogen gas (N₂) before the system is put into operation. Use appropriate source of N₂ – cylinder with control valve. The pressurised system must be pressurised to value corresponding to the operating pressure for the given temperature (see Chapter [4.1](#)).



*Tool charging adapter
ATC001*

Pressurisation is performed through the end-of-line adapter of the BlazeTube detection using charging adapter ATC001. The BlazeTube detection end-of-line adapter has a port with thread M10x1 and contain a Schrader valve.

This valve closes and opens automatically during removal or installation of the charging adapter or the pressure gauge. It is possible to install and remove these components even when the tube is under pressure.

Depending on the cylinder valve used, proceed according to instructions in Chapter [7.5.1](#) or [7.5.2](#) to pressurise both the cylinder and BlazeTube at once or BlazeTube separately. For pressurisation of the cylinder only, follow steps in the technical bulletin *TB-FDPF Filling DLP Systems with PO or FK*.

For multiple cylinder configurations, follow steps in Chapter [8.3.1](#).

If your system uses pneumatic remote actuator (ARA010 or ARA020), you can also pressurise the system following procedures in the corresponding Annex.



Proceed carefully and strictly follow the following steps. Fasten the connectors of the tubes, charging adapter and BlazeTube detection firmly and inspect. Their accidental disconnecting during pressurisation would release the extinguishing agent into the system.



Never connect or disconnect the charging adapter to the BlazeTube detection if the ball valve of the outlet of the BlazeTube detection on the cylinder valve is open.



Due to risk of activation during pressurisation of the system it is necessary to seal the outlets of the discharge networks on the cylinder valve. Remove the discharge networks and seal the outlets with the G3/8" valve plugs.



Pressurise the BlazeTube detection correctly. If the pressure in it is lower than in the cylinder, the valve piston of the cylinder could open and extinguishing agent could be released when opening the ball valve.

7.5.1 PRESSURISATION PROCEDURE OF THE CYLINDER AND THE DETECTION SYSTEM – VALVES 201 AND 202

Proceed according to instructions in this chapter to pressurise the cylinder and BlazeTube detection at once.

For pressurisation of BlazeTube detection only, skip steps 6 and 7.

Procedure for valves 211-01 and 212-01 is described in Chapter [7.5.2](#), valves 211-30 and 212-30 (without BlazeTube outlet) in Chapter [8.3.2](#).

Step 1:

Make sure that the discharge ports are plugged with valve plugs FVP1B06, to avoid loss of agent in case of an accidental discharge when pressurising.

Make sure that the ball valve on the cylinder valve is closed.

Read and write down the value of pressure from the pressure gauge on the cylinder valve.

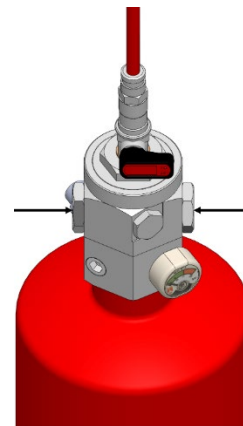

Step 2:

If installed, remove the pressure gauge (pressure switch or transducer) from the end-of-line adapter AEA006 at the end of the BlazeTube.

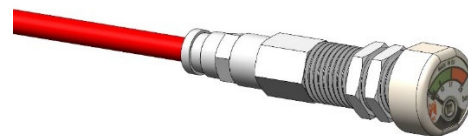

Step 3:

Make sure the ball valve on the charging adapter is closed.

Mount by hand the charging adapter ATC001 to the end-of-line adapter's M10x1 port by rotating clockwise. Hold the end-of-line adapter to push counter-clockwise while tightening. Tighten the charging adapter properly.

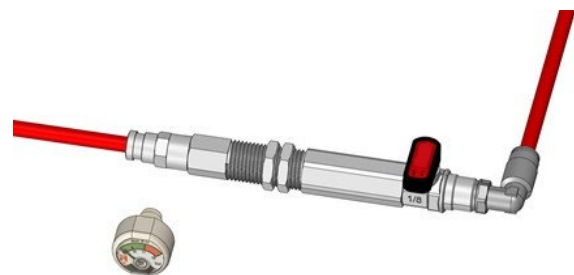

AUTOMATIC FIRE SUPPRESSION SYSTEMS



Step 4:

Set the regulator on the source of N₂ to the desired value (**25 bar at 20 ± 3 °C ambient temperature**). Setting must be at least 1 bar higher than the pressure in the cylinder. Graph of relationship between temperature and pressure in the cylinder is show in Chapter [4.1](#). Open the regulator valve.



Step 5:

Slowly open the ball valve of the charging adapter and pressurise the BlazeTube detection first.

During pressurisation hissing can be heard. When the sound stops, pressurisation is finished. Keep the ball valve open for at least 30 seconds to stabilize the pressure in the BlazeTube detection.

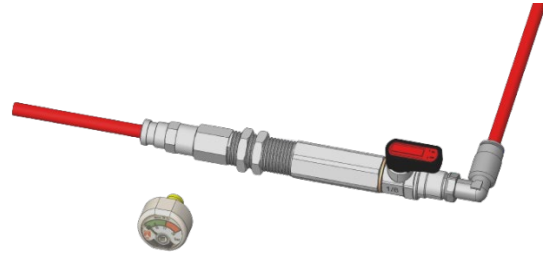

Step 6 (skip if pressurising only the BlazeTube):

Slowly open the ball valve on the cylinder valve and pressurise the cylinder.

During pressurisation hissing can be heard, the cylinder may jump once and a bang can be heard. When the hissing stops, keep the ball valve open for at least 30 seconds to stabilize the pressure.

Close the ball valve on the cylinder valve, shake the cylinder several times and repeat Step 6 until the pressure stabilises at the desired value.

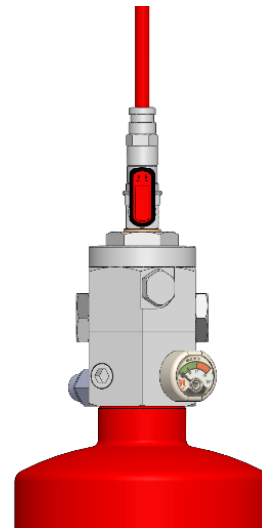

Step 7 (skip if pressurising only the BlazeTube):

Close the ball valve on the cylinder valve.

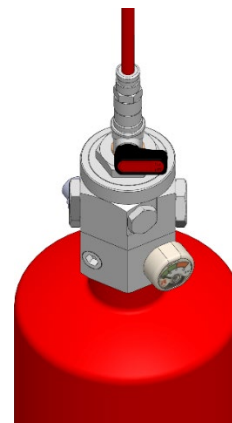

Step 8:

Close the ball valve on the charging adapter.

Step 9:

Unscrew the charging adapter from the M10x1 port of the end-of-line adapter (with size 16 spanner). You can use size 14 spanner on the valve adapter to push clockwise while unscrewing the charging adapter.



Step 10:

Mount the pressure gauge (pressure switch or transducer) back. Tighten it with spanner 22 mm.

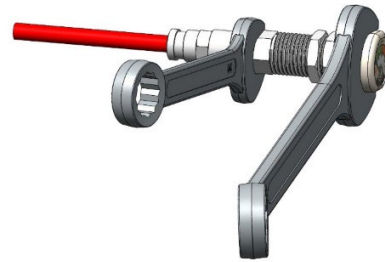

Step 11:

If the pressure is not decreasing, very slowly open the ball valve on the cylinder valve. Pressures in the tube and the cylinder will equalise. Wait approximately 30 seconds.

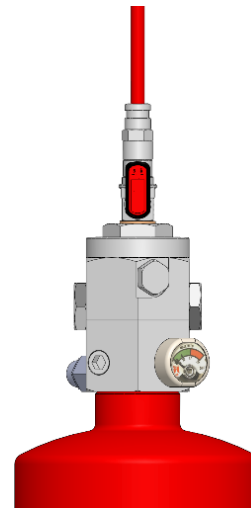

Follow additional steps from Chapter [7.5.3](#).



Since this moment the cylinder and the BlazeTube detection are connected in one pressure unit. Proceed carefully not to damage the BlazeTube detection. Its damage would cause activation of the system and release of extinguishing agent.



Do not try to remove the BlazeTube detection from the BlazeTube outlet on the cylinder valve or remove the end-of-line adapter if the BlazeTube is under pressure and the ball valve is open.



Fast and careless opening of the ball valve may activate the system and release extinguishing agent.

7.5.2 PRESSURISATION PROCEDURE OF THE CYLINDER AND THE DETECTION SYSTEM – VALVES 21X-01

Proceed according to instructions in this chapter to pressurise the cylinder and BlazeTube detection at once.

For pressurisation of BlazeTube detection only, skip **Step 7** and **Step 8**.

Procedure for valves 201 and 202 is described in Chapter [7.5.1](#), valves 211-30 and 212-30 (without BlazeTube outlet) in Chapter [8.3.2](#).

Step 1:

Make sure that the discharge ports are plugged with valve plugs FVP1B06, to avoid loss of agent in case of an accidental discharge when pressurising.

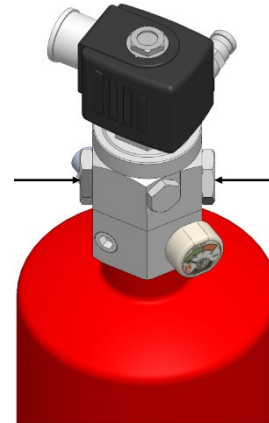

Step 2:

Make sure that the ball valve on the cylinder valve is closed.

Read and write down the value of pressure from the pressure gauge on the cylinder valve.



Step 3:

If installed, remove the pressure gauge (pressure switch or transducer) from the end-of-line adapter AEA006 at the end of the BlazeTube.

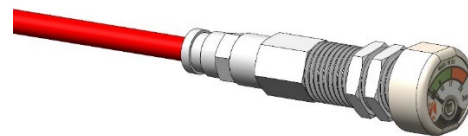

Step 4:

Make sure the ball valve on the charging adapter is closed.

Mount by hand the charging adapter ATC001 to the end-of-line adapter's M10x1 port by rotating clockwise. Hold the end-of-line adapter to push counter-clockwise while tightening. Tighten the charging adapter properly.

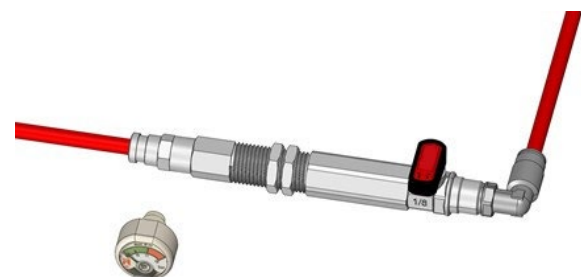

Step 5:

Set the regulator on the source of N₂ to the desired value (**25 bar at 20 ± 3 °C ambient temperature**). Setting must be at least 1 bar higher than the pressure in the cylinder. Graph of relationship between temperature and pressure in the cylinder is show in Chapter [4.1](#). Open the regulator valve.



AUTOMATIC FIRE SUPPRESSION SYSTEMS



Step 6:

Slowly open the ball valve of the charging adapter and pressurise the BlazeTube detection first.

During pressurisation hissing can be heard. When the sound stops, pressurisation is finished. Keep the ball valve open for at least 30 seconds to stabilize the pressure in the BlazeTube detection.

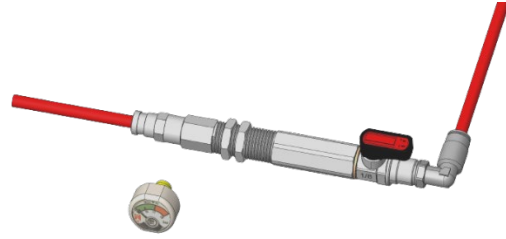

Step 7 (skip if pressurising only the BlazeTube):

Slowly open the ball valve on the cylinder valve and pressurise the cylinder.

During pressurisation hissing can be heard, the cylinder may jump once and a bang can be heard. When the hissing stops, keep the ball valve open for at least 30 seconds to stabilize the pressure.

Close the ball valve on the cylinder valve, shake the cylinder several times and repeat Step 6 at least once.



Step 8 (skip if pressurising only the BlazeTube):

Close the ball valve on the cylinder valve.



Step 9:

Close the ball valve on the charging adapter.

Step 10:

Unscrew the charging adapter from the M10x1 port of the end-of-line adapter (with size 16 spanner). You can use size 14 spanner on the valve adapter to push clockwise while unscrewing the charging adapter.



Step 11:

Mount the pressure gauge (pressure switch or transducer) back. Tighten it with spanner 22 mm.



Step 12:

If the pressure is not decreasing, very slowly open the ball valve on the cylinder valve. Pressures in the tube and the cylinder will equalise. Wait approximately 30 seconds.

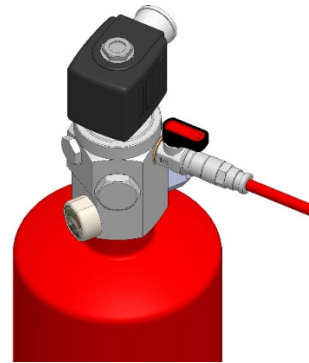

Follow additional steps from Chapter [7.5.3](#).



Since this moment the cylinder and the BlazeTube detection are connected in one pressure unit. Proceed carefully not to damage the BlazeTube detection. Its damage would cause activation of the system and release of extinguishing agent.



Do not try to remove the BlazeTube detection from the BlazeTube outlet on the cylinder valve or remove the end-of-line adapter if the BlazeTube is under pressure and the ball valve is open.



Fast and careless opening of the ball valve may activate the system and release extinguishing agent.

7.5.3 ADDITIONAL STEPS AFTER PRESSURISATION

Observe the value on the cylinder valve's pressure gauge and check the system components for leaks right away and after 30 minutes. If pressure is decreasing, the BlazeTube detection may not be connected properly or some component may not be mounted tightly. Also check the connection between the cylinder neck ring and the cylinder valve using a foaming solution. Observe if no bubbles are formed due to loss of pressure through the connection.

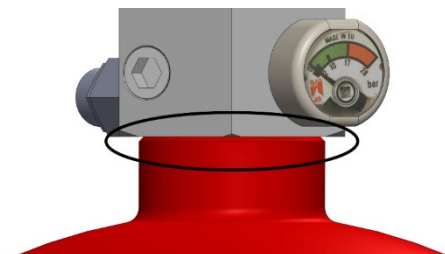

Connection between the cylinder neck ring and the valve

IMPORTANT!

Never install the cylinder assembly if any leak is detected!

7.6 FINAL INSPECTION OF THE SYSTEM INSTALLATION

Fill-out the Commissioning/Installation Report.

8 REGULAR INSPECTION AND MAINTENANCE OF THE FIRE SUPPRESSION SYSTEM



Pressure configuration of the system is reserved technical equipment under pressure. Its activation and operation is subject to professional inspections and tests performed by revision technician according to applicable legislation. Operator is obliged to have inspections of safety condition of the equipment performed and immediately remove defects detected.



Always follow local legislation and statutory requirements.



All inspections (except daily operator’s checks) and repairs, whether during regular maintenance or in exceptional situation, must be performed by a person authorized and trained by the manufacturer and depending on the procedure with corresponding professional qualification to ensure correct operation of the fire suppression system.

Required system inspection and maintenance must be followed to ensure long term, reliable and safe operation of BlazeCut system.

Visual inspections of the fire suppression system shall be carried out regularly at least once a month by the responsible person. Overall inspection must be performed at least once in 12 months for non-harsh environments and once per 6 months for harsh environments. Inspection must be performed also after each exceptional circumstance (e.g., accidental activation, exposure to mechanical or excessive thermal stress for example in case of fire without activation of the system).

In case of performing exceptional inspection, the 12-month period to perform the next regular inspection starts only when exceptional inspection was performed in full scope.

Regular replacement of components subject to wear and tear (effects of temperature, pressure and environment) is also necessary in BlazeCut system.

Proceed according to the instructions in the table below.

Table 59: Overview of inspections

Period / interval	Obligatory scope
Daily operator’s check	<ol style="list-style-type: none"> 1. Check System pressure 2. Fire Alarm Panel check (if used) 3. Ensure actuators are undamaged and tamper seals are in place and in good condition (if used) 4. Visual inspection of system: check for loose and/or damage to cylinder assembly, hoses, brackets, nozzles/caps, detection, etc.
1 x 12 months	<ol style="list-style-type: none"> 1. Overall inspection of the system 2. Inspection of pressure in the system
1 x 10 years	<ol style="list-style-type: none"> 1. Overall inspection of the system 2. Pressure test or replacement of the cylinder 3. Service of the cylinder valve (see technical bulletin <i>TB-OIV-EN Overhaul for ILP Valves</i>) 4. Replacement of the extinguishing agent 5. Replacement of BlazeTube detection (if used)
As necessary	<ol style="list-style-type: none"> 1. Pressurisation of the system 2. Replacement of wear and tear parts

NOTE

To prevent settling and compacting of the powder agent in vibration environment e.g., mobile applications, it is recommended to remove the cylinder from its holder and shake it at least every 5 years. As appropriate, also use a rubber mallet to knock on the cylinder sides and bottom. Make sure not to damage the cylinder’s surface or any other component.

If any deficiencies are found, appropriate corrective action shall be taken immediately.

Inspection and test intervals stated in the table are minimum intervals required by the manufacturer. If the legislation in place of installation requires shorter intervals as stated in the table or additional inspections and tests, which are not stated in the table, it is necessary that these inspections are performed in accordance with this legislation. Additionally, if the environment where the system is installed is harsh (e.g., mining applications), the system may require inspections every 3-6 months due to possible damage that may occur.

Agents removed from containers during service or maintenance procedures shall be recovered and recycled or disposed of in accordance with any applicable laws and regulations.

8.1 FINAL INSPECTION OF THE SYSTEM INSTALLATION

Basic points of inspection of the system:

- check completeness of the system,
- clean surface of the cylinder and the cylinder valve, tubes, hoses, pressure gauges and nozzle dust caps from major dirt,
- check surface of the cylinder, focus on possible changes in shape of the cylinder, mechanical damage, signs of corrosion, signs of leak, etc.,
- check firmness of the connection of the discharge network, check correct tightening of the fittings with a spanner,
- check firmness of the connection of the BlazeTube detection by gently pulling the tube,
- check that the discharge network is not damaged, focus on possible change of shape, colour, dents, damage caused by temperature or mechanical damage,
- check firmness of the fastening of the cylinder in the bracket, check the fastenings of the hoses/tubes, of the nozzles, firmness of the fastening of the electrical installation, check firmness of the mounting of the cable connectors depending on installed components (the solenoid, the pressure switch/transducer, the alarm panel etc.),
- check cleanliness of the nozzle caps; the nozzles cannot be covered with dirt and grease; do not clean forcibly, make sure the nozzle caps are not loose,
- Force air through the discharge line and blow off nozzle caps to ensure all delivery lines are clear and caps will open,
- manual actuators – check actuator housing for damage and security, condition of indicator gauge if fitted,
- electric system – check condition of BlazeWire and check supports,
- clean and check that all corresponding labelling of the system and warning labels marking the area protected by BlazeCut system are undamaged.

Remove detected defects immediately. During replacement of components and reconnecting the hoses/tubes, the electrical installation and during pressurisation of the system proceed in accordance with the procedures described in Chapter [12](#).

8.2 INSPECTION OF THE SYSTEM INSTALLATION

8.2.1 GENERAL RULES

The pressure of the system is inspected by control pressure gauge situated on the cylinder valve or on the end-of-line adapter. If both pressure gauges are installed use the most accessible pressure gauge.

During inspection of pressure, the ball valve on the cylinder valve must be open to inspect pressure in the system correctly (like during regular operation of the system). During inspection the system cannot be heated (e.g., during operation of the protected enclosure) and exposed to a direct sunlight.

8.2.2 DAILY OPERATOR PRESSURE CHECK

Read the pressure gauge. If the pressure is within the green zone, the system is operational. If the pressure indicator is in the red zone, contact the service technician.



Pressure level is optimal



Pressure level is critical

If the system is using a Pressure Switch APS001-xx, APS003-xx for monitoring of low pressure or a Pressure Transducer ATA100 for constant monitoring with the AAP210 or AAP211 panel the visual check of pressure gauge is not necessary as the alarm panel will notify the operator by warning light and buzzer on the panel, in case of low pressure.

8.2.3 12-MONTH PRESSURE INSPECTION



When mounting and unmounting the pressure gauge or control pressure gauge to the end-of-line device, the ball valve of the outlet of the BlazeTube detection must be always closed.

During inspection proceed as follows:

- Read the pressure from a pressure gauge (on the cylinder valve or end-of-line adapter) and remove the pressure monitoring device from the end-of-line adapter.
- Measure pressure by installing control pressure gauge (with adapter compatible with outlet M10x1) and compare detected value with data from the pressure gauge of the system. Values must be equal, permissible tolerance of pressure is maximum 1 bar. In case of discrepancy, replace the pressure gauge of the system.
- If the control pressure gauge detects pressure in the system lower by more than 10 % than the required value of pressure, taking into consideration ambient temperature (see Chapter [4.1](#)), perform the pressurisation of the system and proceed according to Chapter [8.3](#).

8.3 PRESSURISATION OF THE SYSTEM

During the operation of the system there is always a natural slight pressure leak in the system. The leak occurs on the BlazeTube connectors and through the BlazeTube detection itself due to permeability of the material. The operation conditions and the size of the cylinder also influence the pressure decrease. Therefore, it is necessary to pressurise the system occasionally if the pressure decrease is more than 10 %.

During pressurisation of the system during maintenance the cylinder is also pressurised as opposed to pressurising only the BlazeTube detection during installation.

Pressurisation is performed through the end-of-line adapter of the BlazeTube detection. The BlazeTube detection end-of-line adapter has outlet with thread M10x1 and it contains Schrader valve, which must be pushed and opened with the charging adapter. This valve closes and opens automatically during removal or installation of the charging adapter.

For valves 201, 202, 211 and 212 follow steps in Chapter [7.5](#).

For multiple cylinder configurations, follow steps in Chapter [8.3.1](#).

If your system uses pneumatic remote actuator (ARA010 or ARA020), you can also pressurise the system following procedures in the corresponding Annex.

8.3.1 SYSTEMS WITH BLAZETUBE – VALVES 201, 202, 203

Use the charging adapter ATC001 with swivel neck. Procedure of pressurisation using end-of-line adapters AEA006 is shown in figures below.

Procedure for valves 201 and 202 is described in Chapter [7.5.1](#), for valves 211-01 and 212-01 is described in Chapter [7.5.2](#).



Proceed carefully and strictly follow the following steps. Fasten the connectors of the tubes, charging adapter and BlazeTube detection firmly and inspect. Their accidental disconnecting during pressurisation would release the extinguishing agent into the system.



Due to risk of activation during pressurisation of the system it is necessary to seal the outlets of the discharge networks on the valve. Remove the discharge networks and seal the outlets with the G3/8" valve plugs.



Never connect or disconnect the charging adapter to the BlazeTube detection if the ball valve of the outlet of the BlazeTube detection on the cylinder valve is open.

Step 1:

Make sure that the discharge ports are plugged with valve plugs FVP1B06, to avoid loss of agent in case of an accidental discharge when pressurising.

For MMC: Make sure Step 1. is carried out on all cylinders.

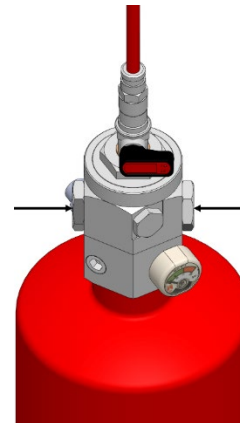

Step 2:

Make sure that the ball valve on the cylinder valve is closed.

Read and write down the value of pressure from the pressure gauge on the cylinder valve.

For MMC: Make sure Step 2. is carried out on all cylinders and pressure in all cylinders is the same.

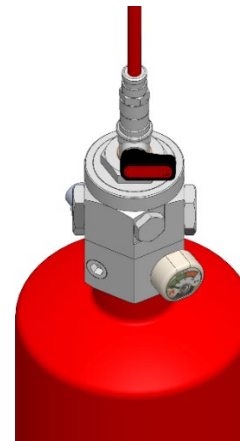

Step 3:

If installed, remove the pressure gauge (pressure switch or transducer) from the end-of-line adapter AEA006 at the end of the BlazeTube.

Step 4:

Make sure the ball valve on the charging adapter is closed.

Mount by hand the charging adapter ATC001 to the end-of-line adapter's M10x1 port by rotating clockwise. Hold the end-of-line adapter to push counter-clockwise while tightening. Tighten the charging adapter properly

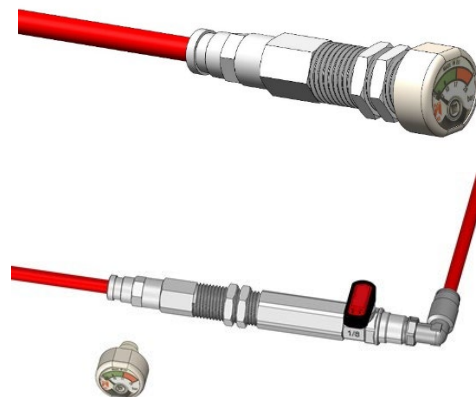

Step 5:

Set the regulator on the source of N₂ to the desired value (**25 bar at 20 ± 3 °C ambient temperature**). Setting must be at least 1 bar higher than the pressure in the cylinders. Graph of relationship between temperature and pressure in the cylinder is show in Chapter [4.1](#).



AUTOMATIC FIRE SUPPRESSION SYSTEMS



Step 6:

Slowly open the ball valve of the charging adapter and pressurise the BlazeTube detection first.

During pressurisation hissing can be heard. When the sound stops, pressurisation is finished. Keep the ball valve open for at least 30 seconds to stabilize the pressure in the BlazeTube detection.

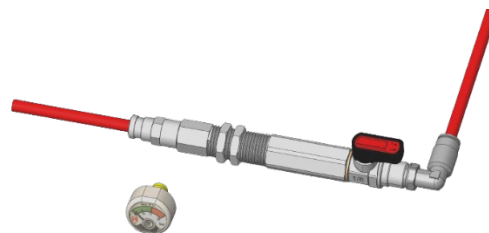

Always open the regulation valve and ball valve of the charging adapter and pressurise the BlazeTube detection first.

Step 7:

Slowly open the ball valve on the cylinder valve and pressurise the cylinder.

During pressurisation hissing can be heard. When the hissing stops, keep the valve open for at least 30 seconds to stabilize the pressure.

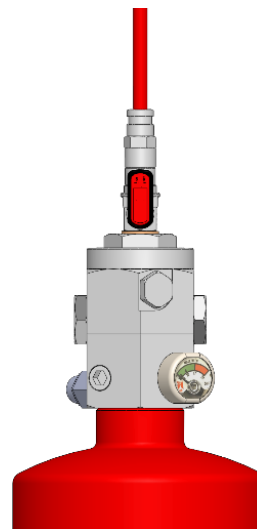

For MCC: On the furthest cylinder (1.), open the ball valve on the cylinder valve and follow **Step 7**. Leave the valve open and repeat Step 7. with cylinder 2. and so on, until all the cylinders are pressurised.

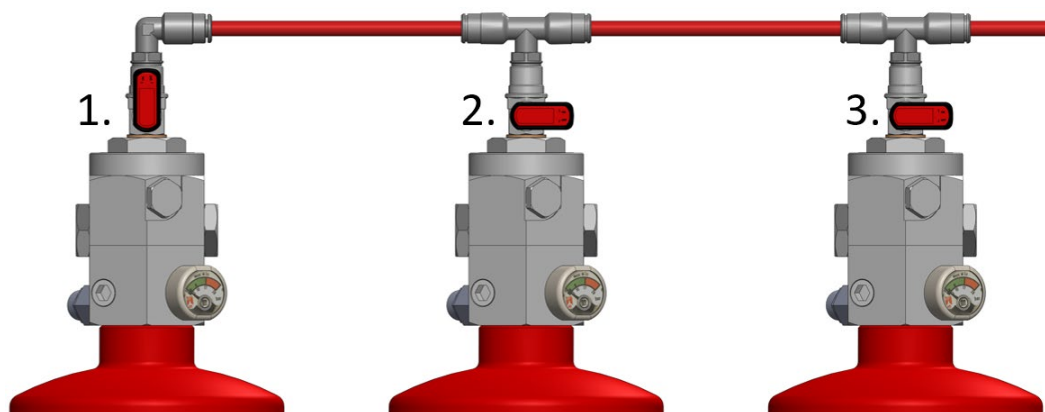

Step 8:

Close the ball valves on all the cylinder valves.

For MCC: Close the ball valve on all the cylinder valves

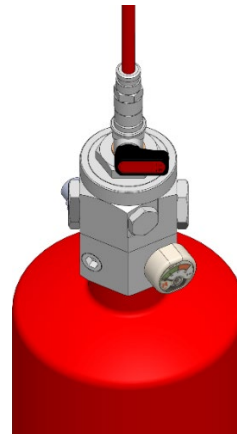

Step 9:

Close the ball valve on the charging adapter.

Step 10:

Unscrew the charging adapter from the M10x1 port of the end-of-line adapter (with size 16 spanner). You can use size 14 spanner on the valve adapter to push clockwise while unscrewing the charging adapter.



Step 11:

Mount the pressure gauge (pressure switch or transducer) back. Tighten it with spanner 22 mm.

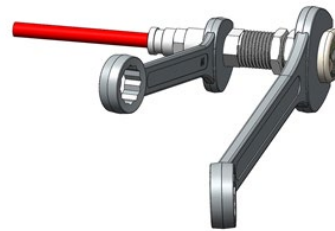

Step 12:

If the pressure is not decreasing, very slowly open the ball valve on the cylinder valve. Pressures in the tube and the cylinder will equalise. Wait approximately 30 seconds.

For MCC: Open the ball valve on all the cylinder valves.

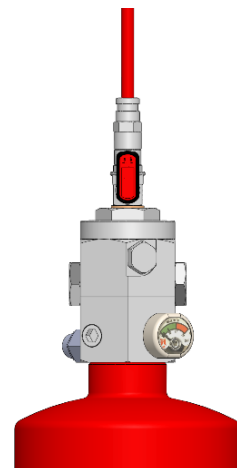

Follow additional steps from Chapter [7.5.3](#)

8.3.2 SYSTEMS WITHOUT BLAZETUBE – VALVES 211-30 AND 212-30

IMPORTANT!

Always charge the cylinder through the valve adapter's M10x1 port.

Step 1:

Make sure that the discharge ports are plugged with valve plugs FVP1B06, to avoid loss of agent in case of an accidental discharge when pressurising.

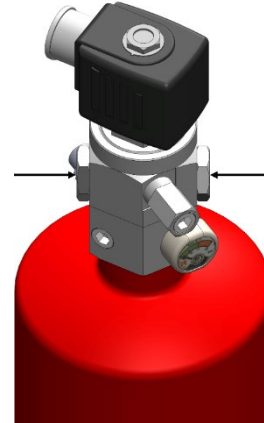

Step 2:

Remove the pressure switch, transducer or M10x1 plug FVP1M10 from the valve adapter FVABM0210 using a size 4 hex key.

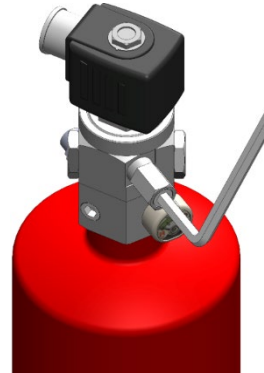

Step 3:

Make sure the ball valve on the charging adapter is closed.

Mount the charging adapter ATC001 to the valve adapter's M10x1 port by rotating clockwise. Tighten the charging adapter properly.



Step 4:

Set the regulator on the source of N₂ to the desired value (25 bar at 20 ± 3 °C ambient temperature).

Setting must be at least 1 bar higher than the pressure in the cylinder. Graph of relationship between temperature and pressure in the cylinder is shown in Chapter 4.1. Open the regulator valve.



AUTOMATIC FIRE SUPPRESSION SYSTEMS



Step 5:

Slowly open the ball valve on the charging adapter and pressurise the cylinder.

During pressurisation hissing can be heard. When the hissing stops, keep the valve open for at least 30 seconds to stabilize the pressure.

When pressurising an unpressurised cylinder, close the ball valve on the charging adapter, shake the cylinder several times and repeat **Step 5** until the pressure stabilises at the desired value.



Step 6:

Close the ball valve on the charging adapter.



Step 7:

Unscrew the charging adapter from the M10x1 port of the valve adapter FVABM0210 (with size 16 spanner). You can use size 14 spanner on the valve adapter to push clockwise while unscrewing the charging adapter.



Step 8:

Screw in the M10x1 plug FVP1M10 and tighten it using a size 4 hex key.



Follow additional steps from Chapter [8.3.3](#).

8.3.3 ADDITIONAL STEPS AFTER PRESSURISATION

Observe the value on the cylinder valve's pressure gauge and check the system components for leaks right away and after 30 minutes. If pressure is decreasing, some component may not be mounted tightly. Also check the connection between the cylinder neck ring and the cylinder valve using a foaming solution. Observe if no bubbles are formed due to loss of pressure through the connection.

IMPORTANT!

Never install the cylinder assembly if the connection is not tight!

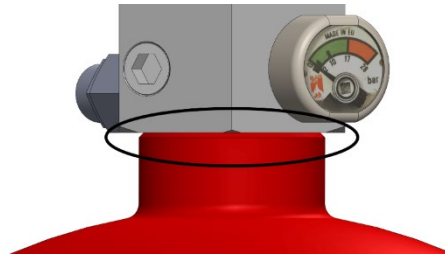

Connection between the cylinder neck ring and the valve

8.4 REMOVAL OF THE SYSTEM FROM SERVICE

The system must be immediately put out of service in the following cases:

- The system has been activated or emptied for other reason.
- The system has been exposed to direct fire or high temperatures exceeding the limits of the system operation.
- The cylinder or valve shows signs of damage (deformation, cracks, leaks, severe corrosion, unusual phenomena that cannot be inspected or removed during operation of the system).
- If the pressure in the system is significantly higher with the respect to the ambient temperature or if it exceeds the highest permissible pressure level of the system.

Subsequent measures to ensure safety of the system and protection of persons must be taken by the persons trained and authorized by the manufacturer and, depending on the procedure, with corresponding professional qualification. If necessary, contact your supplier of the BlazeCut system.

9 OPERATION OF BLAZECUT SYSTEM IN CASE OF FIRE

BlazeCut system is designed to protect closed spaces from fire using volume or local fire suppression applying powder extinguishing agent. BlazeCut system suppresses fire automatically without any external power source (LOP principle) or through electric activation (LHD BlazeWire, detectors etc.).

Below is description of operation using BlazeTube detection, but the principle of operation is the same also with electric activation through LHD BlazeWire, detectors etc.

9.1.1 OPERATION OF SYSTEMS USING VALVE TYPE 20X WITHOUT A SOLENOID – CPO20x

Procedure during automatic activation of the system is described in figure below.

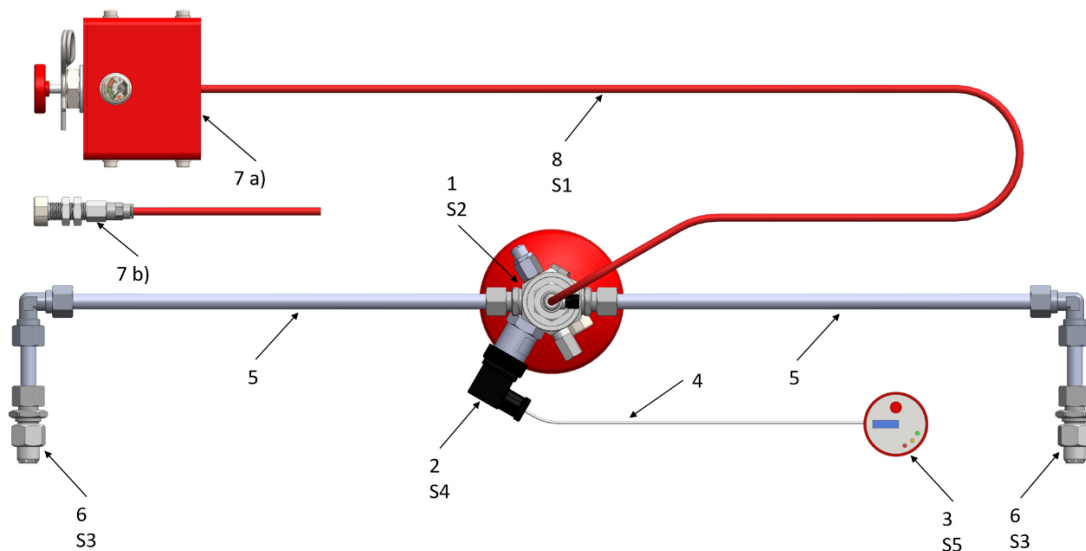

Procedure during automatic activation of the system

1. Cylinder valve (view from above)
2. Pressure Switch/Transducer with a cable connector
3. *External device (e.g., Alarm Panel AAP210)
4. Electrical cables
5. Extinguisher distribution network
 - a) steel tubing and fittings
 - b) Fire hose and fittings
 - c) combination of steel tubing and Fire hoses, fittings
6. Nozzles
7. End-of-line device
 - a) pneumatic remote actuator
 - b) End-of-line connector with a manometer
 - c) another cylinder (without a solenoid – valve type 20x) for multiple cylinder connection
 - d) another cylinder (with a solenoid – valve type 21x-01) for multiple cylinder connection
8. BlazeTube detection

Step 1. BlazeTube detection (8.) detects fire

Step 2. Piston of the cylinder valve (1.) opens as a result of decrease of pressure in the BlazeTube detection (8.)

Step 3. Release of the extinguishing agent through nozzles (6.)

Step 4. * The Pressure Switch/Transducer sends signal to the external device after decrease of pressure in the system

Step 5. * External device makes the operation

*Applicable only when the Pressure Switch/Transducer is installed.

The system can be activated manually using a remote pneumatic actuator.

9.1.2 OPERATION OF SYSTEMS USING VALVE TYPE 211 AND 212 WITH A SOLENOID – CPO21x

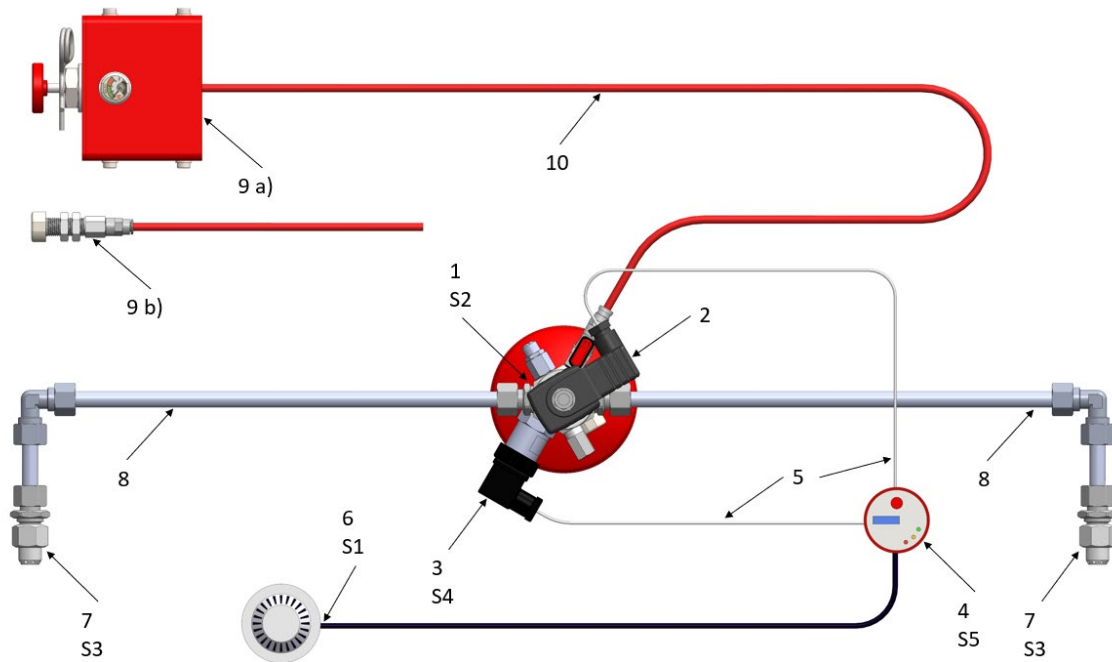

Procedure during automatic activation of the system with valve type 21x-01

1. Cylinder valve (view from above)
2. Solenoid with a cable connector
3. Pressure Switch/Transducer with a cable connector
4. **External device (e.g., Alarm Panel AAP211)
5. Electrical cables
6. Fire detection device
 - a) heat/smoke detector and electrical cable
 - b) BlazeWire and end-of-line resistor
7. Nozzles
8. Extinguisher distribution network
 - a) steel tubing and fittings
 - b) Fire hose and fittings
 - c) combination of steel tubing and Fire hoses, fittings
9. End-of-line device
 - a) pneumatic remote actuator
 - b) End-of-line connector with a manometer
 - c) another cylinder (without a solenoid – valve type 20x) for multiple cylinder connection
10. BlazeTube detection

Step 1. Fire detection device (6.) detects fire

Step 2. Piston of the cylinder valve (1.) opens as a result of electric signal to the solenoid (2.)

Step 3. Release of the extinguishing agent through nozzles (7.)

Step 4. * The Pressure Switch/Transducer sends signal to the external device after decrease of pressure in the system

Step 5. ** External device makes the operation

*Applicable only when the Pressure Switch/Transducer is installed.

**External device described on the pictures above shall not be only one device but also separate independent devices.

The system can be activated manually using a remote pneumatic actuator or a solenoid connected to an external device - e.g., Alarm Panel AAP211.

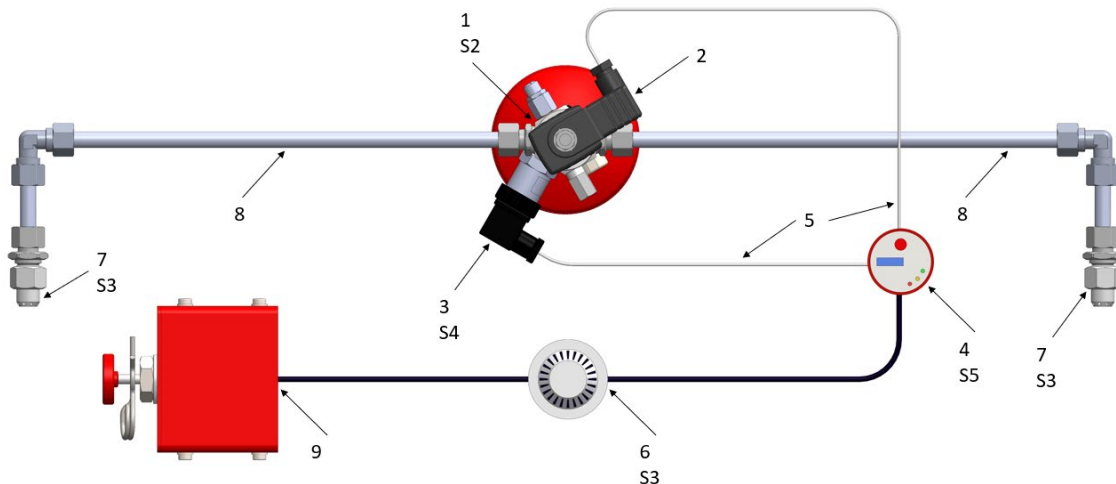

Procedure during manual activation of the system with valve type 21x-30

1. Cylinder valve (view from above)
2. Solenoid with a cable connector
3. Pressure Switch/Transducer with a cable connector
4. **External device (e.g., Alarm Panel AAP211)
5. Electrical cables
6. Fire detection device
 - a) heat/smoke detector and electrical cable
 - b) BlazeWire and end-of-line resistor
7. Nozzles
8. Extinguisher distribution network
 - a) steel tubing and fittings
 - b) Fire hose and fittings
 - c) combination of steel tubing and Fire hose, fittings
9. Electric remote actuator

Step 1. Fire detection device (6.) detects fire

Step 2. Piston of the cylinder valve (1.) opens as a result of electric signal to the solenoid (2.)

Step 3. Release of the extinguishing agent through nozzles (7.)

Step 4. * The Pressure Switch/Transducer sends signal to the external device after decrease of pressure in the system

Step 5. ** External device makes the operation

*Applicable only when the Pressure Switch/Transducer is installed.

**External device shall not be only one device but also separate independent devices.

The system can be activated manually using solenoid connected to an external device - e.g., Alarm Panel AAP211, remote electric actuator.

9.1.3 WARNINGS



Do not manually activate the system without reason. Use manual activation only in case of reasonable suspicion of fire in the protected enclosure.



Do not manually activate the system if persons are present in the protected enclosures.



In case of fire the system activates automatically without previous warning. Do not come to immediate proximity of the nozzles of the system in case of fire, there is risk of being struck by extinguishing agent.



If the system is activated wait for its activity to finish. Do not enter the protected enclosures and do not open the covers of the protected enclosure during the activity of the system.



In case of fire in the vehicle the driver must immediately stop the vehicle, stop the engine of the vehicle and perform further measures according to operation instructions of the vehicle (for example cut-off the supply of gas/fuel) in order to protect the persons and property according to applicable legislation.

10 RESTORATION OF ACTIVITY OF BLAZECUT SYSTEM IN CASE OF FIRE



Install and use BlazeCut system only with original supplied components. Do not replace anything in the system; use only original component and spare components. Using components not approved by the manufacturer causes loss of warranty, may cause malfunction of the system and presents danger to life and health of persons.



The system may be installed, maintained and repaired only by persons trained or authorized by the manufacturer and depending on procedure also with relevant professional qualification. Unprofessional interference with the system may cause malfunction of the system and presents danger to safety and health of people.

After using the system in case of fire, ventilate the protected enclosure properly, do not interfere with or work in the area before ventilation.

After the fire extinguishing is finished, follow the instructions below:

- Enter the protected area only after the system operation is finished.
- Unless absolutely necessary (e.g., fire is still present and it is necessary to use a portable fire extinguisher), enter the protected area only after it has been properly ventilated and cooled off and make sure that entry is safe.
- If immediate entry is necessary, persons should be properly protected (using mask, protective clothing, gloves, glasses etc.).

If the system is automatically activated in case of fire in the protected enclosure, it is necessary to replace several components. Proceed as follows:

- Check all components of the system for any damage. Any part that was exposed to direct fire or temperature above maximum operation temperature of the component shall be replaced,
- Replace the cylinder with extinguishing agent – it is possible to replace the cylinder assembly (cylinder, extinguishing agent, valve) or only cylinder with extinguishing agent and use old valve that needs to be serviced – ask the BlazeCut system supplier for refilled cylinder or refilled cylinder assembly. Proceed according to Chapter [12.2](#). of this Manual,
- Replace the detection (BlazeTube or BlazeWire) if the reason for system activation was detection of fire through this detection system - BlazeTube detection is replaced always in whole length (proceed according to Chapter [12.3](#). of this Manual; BlazeWire must be replaced at least 3 meters on each side of the detection point or damaged part,
- Replace caps on all nozzles,
- Force air through the discharge line to ensure all delivery lines are clear before installing new caps,
- Check if electrical installation was not damaged, replace possible damaged parts,
- Clean all components from the powder and dirt caused by the fire,
- When all components are checked, cleaned and replaced connect the cable connectors to the Pressure Switch/Transducer or solenoid and check correct functioning of the electrical installation.

During installation of new components or their replacement and during repeatedly connecting the tubes/hoses, electrical installation and pressurisation of the system proceed according to instruction in respective Chapters.

Proceed likewise in case of manual activation of the system or accidental activation of the system for other reasons.

11 SYSTEM DEACTIVATION

If necessary, BlazeCut system may be disabled without removing it from of the protected enclosure. Disablement is possible as follows:

11.1.1 DISABLEMENT OF THE BLAZETUBE DETECTION (AUTOMATIC ACTIVATION)

Close the ball valve on the cylinder valve. In this case even after damaging the tube the cylinder valve does not open and extinguishing agent is not released. However, it remains possible to activate the system manually from the external device (e.g., AAP211 alarm panel) using solenoid.

11.1.2 DISABLEMENT OF ELECTRICAL ACTIVATION – ONLY FOR SYSTEMS WITH THE VALVE TYPE 211 AND 212 WITH SOLENOID

Disconnect the cable connector from the solenoid on the cylinder valve. Protect uncovered electrical connectors from dirt (e.g., by insulation tape). All electrical detection (LHD BlazeWire or detectors) and electrical manual activation is now disabled. In this case automatic activation using the BlazeTube detection remains active.

11.1.3 TOTAL DISABLEMENT OF THE SYSTEM

Disable the BlazeTube detection and solenoid. The system cannot be activated.

12 MAINTENANCE OF THE SYSTEM, REPLACEMENT OF COMPONENTS

12.1 GENERAL RULES

Follow general rules stated in Chapter [3.1](#).

Fill-out the Maintenance/Inspection Report.

12.2 REPLACEMENT OF THE CYLINDER

During replacement use only undamaged cylinder filled with the correct extinguishing agent, properly labelled, with correctly mounted cylinder valve. Cylinder assembly is supplied **unpressurised** as standard. Pressurise the new cylinder according to instructions in Chapter [7.5](#). Pressures corresponding to actual temperature are stated in Chapter [4.1](#).

If the pressure gauge is not mounted on the cylinder valve, external control pressure gauge with adapter compatible with an outlet with thread M10x1 on the cylinder valve or the pressure gauge of the BlazeCut system which is mounted on the end-of-line adapter of the BlazeTube detection may be used. In such case, remove the pressure gauge from the end-of-line adapter of the BlazeTube detection and mount it to the outlet on the cylinder valve with thread M10x1.

During replacement of the cylinder proceed as follows:

1. Close the ball valve on the cylinder valve of the old cylinder assembly. Disconnect cable connectors on the Pressure Switch/Transducer or solenoid, if used in the system and remove the Pressure Switch/Transducer.
2. If the BlazeTube detection is under pressure, remove the pressure gauge (pressure switch or transducer) from the end-of-line adapter AEA006 at the end of the BlazeTube, if installed. Push in the Schrader valve inside the end-of-line adapter to release the pressure from the BlazeTube.

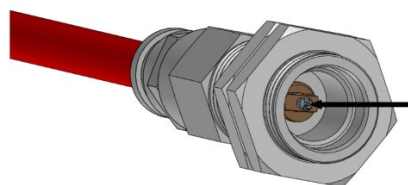

Schrader valve inside the end-of-line adapter

3. Disconnect the BlazeTube detection and the distribution tubes/hoses.
4. Loosen the clamps of the bracket of the cylinder and remove it from the bracket.
5. Place a new cylinder assembly into the bracket and fasten properly with clamps.
6. Connect the BlazeTube detection, the distribution tubes/hoses on the cylinder valve, install the Pressure Switch/Transducer and connect the cable connector, if used in the system and connect the cable connectors of the electrical components.
7. If the removed cylinder assembly is under pressure, seal both outlets of distribution tubes with thread G3/8" with corresponding valve plugs.

After replacement of the cylinder assembly, have corresponding safety inspection of the pressure device performed according to Chapter [8](#).

During removal and installation of individual components proceed according to the instructions as stated in individual Chapters relating to components.

12.3 REPLACEMENT OF THE BLAZETUBE DETECTION



Do not try to remove the BlazeTube detection from the cylinder valve when the tube is under pressure and the ball valve on the cylinder valve is open.



Before handling the BlazeTube detection during removal, replacement or adjustment fastening in the protected enclosure always close the ball valve on the cylinder valve where the tube is fastened. When the BlazeTube detection is connected to the cylinder valve and the ball valve is open, if the tube is damaged and the pressure decreases, the fire suppression system is always activated and the extinguishing agent is released completely.



During disconnection of the BlazeTube detection under pressure a pressure is released and if the system was in operation also small amount of agent is released. In such case always wear appropriate protective glasses with side-shields and suitable protective gloves. Aim the BlazeTube detection always apart. Make sure not to interpose any other person.

1. Close the ball valve on the cylinder valve, position of the lever as shown in figure below.
2. If the BlazeTube detection is under pressure, remove the pressure gauge (pressure switch or transducer) from the end-of-line adapter AEA006 at the end of the BlazeTube, if installed. Push in the Schrader valve inside the end-of-line adapter to release the pressure from the BlazeTube.

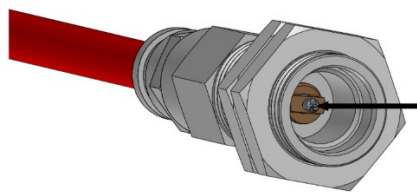

Schrader valve inside the end-of-line adapter

3. Disconnect the BlazeTube detection from the connector on the cylinder valve. Disconnect the BlazeTube by pushing the ring inwards in the place of entry of the tube to the connector and remove the tube. Proceed according to the instructions in Chapter [7.4](#), also when disconnecting the end-of-line adapter. Be careful, if the tube was under pressure, the pressure will leak from the BlazeTube detection.

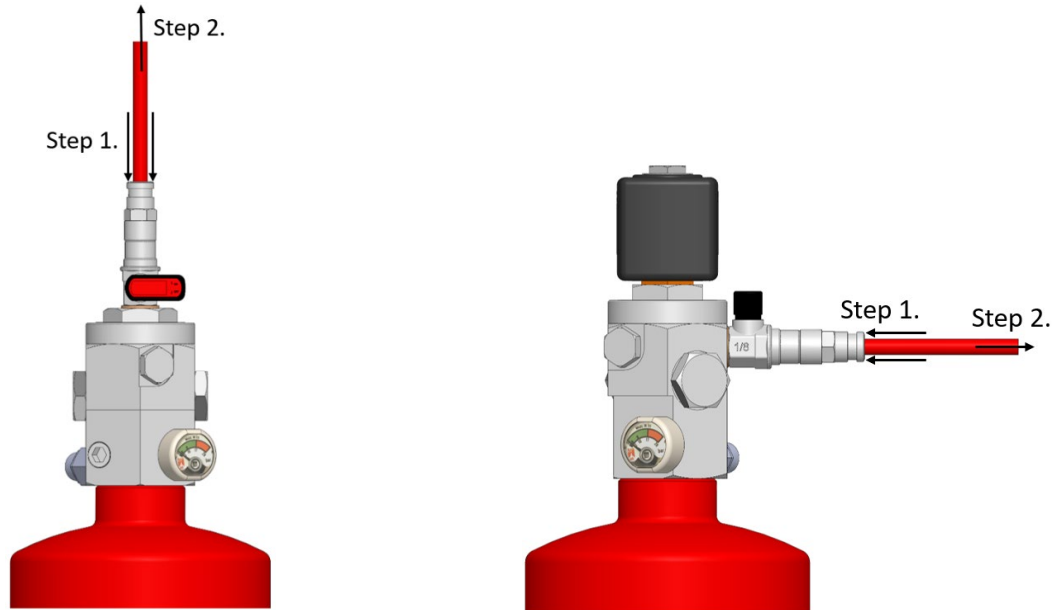

The ball valve is closed

4. Fasten the new BlazeTube detection properly to the connector of the cylinder valve. Fasten the BlazeTube detection so that the tube is slotted to the connector and pushed by hand all the way. After slotting always make sure by pulling that the tube is firmly gripped.
5. Place the BlazeTube detection in the protected enclosure and gradually fasten with clamps/ties.
6. During installation proceed further according to Chapter [7.4](#).
7. Pressurise the BlazeTube detection, proceed according to Chapter [7.5](#).

12.4 RELEASE OF THE PISTON OF THE VALVE IN CASE OF ACCIDENTAL OPENING

In case the valve plugs are installed in outlets for the distribution tubes/hoses and the piston of the valve opens accidentally (e.g., during transport, accidental opening of the ball valve, troubles during pressurisation of the system), it is necessary to release the piston back into closed position.

This operation is possible through the outlet for the BlazeTube detection by using pressure of gas (nitrogen). Close the ball valve on the cylinder valve (if it's open), connect the source of gas to the outlet for the BlazeTube detection by using charging adapter and release the gas under pressure into the outlet. Slowly open the ball valve of the outlet. Piston of the valve will move into closed position; this will be indicated by an audible click. Close the ball valve again.

Due to contamination of piston chamber and outlets by released powder it is necessary, in case of accidental activation of the system with sealed outlets, to depressurise the system and cylinder, and do a maintenance of the valve (See the ILP Valve Maintenance Manual) before the system can be installed and put back to operation.



Never remove the valve plugs before you release the piston back into closed position.

12.5 CLEANING AFTER SYSTEM ACTIVATION



During cleaning process always wear appropriate protective glasses, breathing mask and suitable protective gloves and clothes.

After system activation clean the protected areas as soon as possible preferably by vacuuming the powder or by blowing with air.

Try to remove as much powder as possible from affected area to prevent the powder from absorbing moisture and causing corrosion on metal components.

After the powder is removed you can flush the affected area by clean water.



12.6 CLEANING THE SYSTEM

During maintenance of the BlazeCut system clean the surface of the cylinder, the cylinder valve and the tubes from major dirt with appropriate cleaning textiles or cloths and nonaggressive cleaning products.

Do not use aggressive cleaning products such as solvents and caustic to clean the system.

Do not expose the system and especially its electric parts to direct effect of water pressure during cleaning of the protected enclosure with high-pressure water.

12.7 DECLARATION OF CONFORMITY

Upon installation of each piece of the system the Commissioning/Installation Report must be prepared. Send the original of the Report to the manufacturer of the system. Keep the copy of the original.

Records on the maintenance and inspection of the system indicating the scope of service must be kept. Keep the maintenance records.

Declaration of conformity is issued by the manufacturer for each of the systems. The basis and requirement to issue the declaration of conformity is the Report issued by the authorized qualified person with relevant professional qualification in accordance with the relevant legislation and delivered to the manufacturer, whereby the authorized person certifies correct installation of the system pursuant to the technical documentation.

In the declaration of conformity, the manufacturer declares that the equipment under pressure is in conformity with the certificate of the type of the equipment under pressure issued in accordance with the requirements of European directive 2014/68/EU, Module B+E.

Supervising the implementation of the obligations arising out of the approved quality assurance system is ensured by notified body:

Technická inšpekcia, a.s., Trnavská cesta 56, 821 01 Bratislava, Slovak Republic (NB 1354).

Pursuant to the abovementioned, the equipment under pressure is labelled with CE conformity mark and identification code of notified body: 1354.

The products are safe when the terms of use and technical requirements are observed.

A copy of the current certificates can be requested by emailing technical@blazecutgroup.com

13 LIST OF ANNEXES

[ANNEX 1: DETECTION, SIGNALING AND ACTIVATION DEVICES](#)

[ANNEX 2: PRESSURE MONITORING](#)

[ANNEX 3: PNEUMATIC REMOTE ACTUATORS ARA010 AND ARA020](#)

[ANNEX 4: ELECTRIC REMOTE ACTUATORS ARA110 AND ARA120](#)

ANNEX 1: DETECTION, SIGNALING AND ACTIVATION DEVICES

A1.1. DETECTORS

Table 60: Detectors

Part No	Description
ASD001	Smoke detector with relay output and base, 12 V, IP40, 0°C up to 45°C, EN54. Compatible components: AAP210/211/310 with 12 V power supply (ABP212)
AHD001	Heat detector with relay output and base, 12 V, IP40, -10°C up to 45°C, EN54, actuates at 54°C. Compatible components: AAP210/211/310 with 12 V power supply (ABP212)
AHD002	Heat and smoke detector optical with relay output and base, 12 V, IP40, 0°C up to 45°C, EN54, actuates at 54°C. Compatible components: AAP210/211/310 with 12 V power supply (ABP212)
ASD002	Conventional smoke detector with standard base, 9 - 30 V, IP42, -20°C up to 50°C, EN54. Compatible components: AFP020
AHD003	Conventional heat and smoke detector with standard base, 6 - 30 V, IP42, -20°C up to 50°C, activation temp min. 54°C, max. 65°C, EN54. Compatible components: AFP020
ASD002-RB	Conventional smoke detector with relay base, 9 - 30 V, IP42, -20°C up to 50°C, EN54. Compatible components: AAP210/211/310
AHD003-RB	Conventional heat and smoke detector with relay base, 6 - 30 V, IP42, -20°C up to 50°C, activation temp min. 54°C, max. 65°C, EN54. Compatible components: AAP210/211/310
AER101	End-of-line resistor 1 kΩ for components connected to Alarm Panel AAP210, AAP211 or AAP310. Compatible components: APS001, APS003, ASD001, AHD001, AHD002, ASD002-RB, AHD003-RB, AHP110, AHP240, ABW105, ABW185, ABW240
AHP110	Heat probe detector, switching temperature 110 °C, IP67, operating temperature up to 130 °C, with a 2-pin connector and a mounting nut



ASD001



AHD001



AHD002



ASD002, AHD003, ASD002-RB, AHD003-RB



AER101



AHP110

A1.2. SIGNALLING UNITS

Table 61: Signalling units

Part No	Description
ASU001	Signalling unit, light and sound, 81 dB, CE, 6-28 V DC, CE. Suitable for indoor, fixed, low vibration installations
ASU002	Signalling unit red, sounder and beacon with high base, 114 dB, IP44, EN54-3/CE/LPCB, 24 V DC. Suitable for indoor, fixed, low vibration installations
ASU003	Signalling unit red, sounder and beacon with high base, 101 dB(A), IP65, 18-24 V DC, CE, EN54-3. Suitable for fixed, low vibration installations
ASR001	Sounder red, multi tone with high base, 92 dB to 112 dB, IP65, CE/VdS, LPCB, 9-15 V DC, CE, EN54-3. Suitable for fixed, low vibration installations
ABR001	Beacon red xenon, IP65, CE, VdS, 9V-60Vdc, CE, EN54-3. Suitable for fixed, low vibration installations
ABR002	Beacon red LED, IP65, CE, R10, 12-24 V DC, -20°C to +50°C, 3 bolt mounting. Suitable for outdoor mobile applications.
ASB001	Sounder black, 97 dB, IP65, SAE J994 Type C, AMCA, UL, CE, E, 12-24 V DC, -40°C to +85°C. Suitable for outdoor mobile applications.
AWB012	Warning buzzer with red LED dots, 12 V DC, 80 dB (@1m), IP50, -20 to +50 °C, stainless steel, 29 mm diameter. Suitable for fixed and mobile installations. Includes ALA019 label.
AWB024	Warning buzzer with red LED dots, 24 V DC, 80 dB (@1m), IP50, -20 to +50 °C, stainless steel, 29 mm diameter. Suitable for fixed and mobile installations. Includes ALA019 label.
ASB8666	Sign Board optical acoustic with text: "EXTINGUISHING IN PROGRESS", size of text: 135x320 mm, IP65, 12/24 V, 100 dB @1 m, -10 °C to +50 °C, CE, fixed applications



ASU001



ASU002



ASU003



ASR001



ABR001



ABR002



ASB001



AWB012 and AWB024



ASB8666

A1.3. ALARM PANELS

Table 62: Alarm panels and accessories

Part No	Description
AAP210	Alarm panel without a fire button for C Series, OK, Fault and Fire LED indication (automatic dimmer function), fully configurable via Wi-Fi, include data logging and programmable NO/NC integrated relay output, 9 - 36 V DC, 85 dB buzzer, IP67, -30°C to 70°C, CE, EMC tested, flush or external mounting, red anodized aluminium body, 55 mm diameter. Includes 2x End-of-line Resistor AER101. Note: Requires programming
AAP211	Alarm panel with a fire button for C Series, OK, Fault and Fire LED indication (automatic dimmer function), fully configurable via Wi-Fi, include data logging and programmable NO/NC integrated relay output, 9 - 36 V DC, 85 dB buzzer, IP67, -30°C to 70°C, CE, EMC tested, flush or external mounting, red anodized aluminium body, 55 mm diameter. Includes 2x End-of-line Resistor AER101. Note: Requires programming
AAP310	Alarm panel without a fire button for T and C Series, preconfigured from factory, OK, Fault and Fire LED indication (automatic dimmer function), 9 - 36 V DC, 85 dB buzzer, IP67, -30°C to 70°C, CE, EMC tested, Integrated NO relay output, flush or external mounting, red anodized aluminium body, 55 mm diameter. Includes 1x End-of-line Resistor AER101. Can be used for: a) C Series with just one pressure switch b) as a fire warning device Note: Non-programmable
AAP400	Alarm panel with a test button for T and C Series, preconfigured from factory, OK, Fault and Fire LED indication, 10 - 30 V DC, 85 dB buzzer, IP65, -30°C to 70°C, CE, EMC tested, flush or external mounting, powder coated aluminium body, 64x58x30 mm, 0.5 m cable. Includes 2x End-of-line Resistor AER106. Can be used for: a) C Series with one or two pressure switches b) as a fire warning device Note: Non-programmable
APB210	Panel bracket stainless steel for Alarm Panels AAP210, AAP211 and AAP310
ATS002	Tamper seal for manual button on Alarm Panel AAP211, includes tamper adhesive
ABP212	Back-up power supply 12 V for Alarm Panels AAP210, AAP211 and AAP310, includes 1 x 7.0 Ah battery. For indoor use only
ABP224	Back-up power supply 24 V for Alarm Panels AAP210, AAP211 and AAP310, includes 2 x 7.0 Ah battery. For indoor use only
AFP020	Fire panel conventional (4 zones), extinguishing module included, 2 x 7 Ah accumulators included, internal relay, -5°C to 40°C, 325x325x80 mm, IP40, EN54 and EN12094 certified, for clean agent systems
ACF001	Case for an external fuse, IP66, -20 up to 70 °C, max 10 A (for AEF001, AEF002, AEF100, AEF200)
ACF002	Case for an external fuse, IP50, max 6.3 A (for AEF001, AEF002, AEF100, AEF200)
AEF002	External fuse 2 A for Alarm Panels AAP210, AAP211 and AAP310
AEF200	External fuse 200 mA for Alarm Panel AAP400



AAP210, AAP310



AAP211



AAP400



APB210



ATSO02



ABP212



ABP224



AFP020



ACF001



ACF002



AEF002, AEF200

Table 63: Alarm panel kits

Part No	Content
KAAP210	Alarm Panel AAP210 kit without a fire button for C Series, Panel Bracket APB210, 12-pin Deutsch Connector ADC012, Sealing Plugs ADP001, External Fuse AEF002, Fuse Case ACF001, End-of-line Resistors AER101, labels ALA002, ALA003, ALA004 ALA005
KAAP211	Alarm Panel AAP211 kit with a fire button for C Series, Panel Bracket APB210, Tamper Seal ATSO02, 12-pin Deutsch Connector ADC012, Sealing Plugs ADP001, External Fuse AEF002, Fuse Case ACF001, End-of-line Resistors AER101, labels ALA002, ALA003, ALA004 ALA005
KAAP310	Alarm Panel AAP310 kit without a fire button for T and C Series, Panel Bracket APB210, 6-pin Deutsch Connector ADC006, Sealing Plugs ADP001, External Fuse AEF002, Fuse Case ACF001, End-of-line Resistor AER101, labels ALA002, ALA004 ALA005
KAAP400	Alarm Panel AAP400 kit with a test button for T and C Series, 6-pin Deutsch Connector ADC006, Sealing Plugs ADP001, External Fuse AEF200, Fuse Case ACF002, End-of-line Resistors AER106, labels ALA004 ALA005

AUTOMATIC FIRE SUPPRESSION SYSTEMS

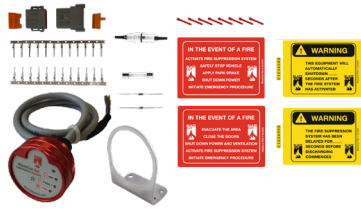

KAAP210



KAAP211



KAAP310



KAAP400

For additional information ask for a component manual *CM-AP2-EN Alarm Panels AAP210, AAP211, AAP310* or *CM-AP4-EN Alarm Panel AAP400*.

A1.4. ELECTRIC ACTUATORS

Table 64: Electric actuators and accessories

Part No	Description
ARA132-YEL	Remote actuator electric, yellow, IP32, -20°C up to +65°C, EN54-11
ARA132-BLU	Remote actuator electric, blue, IP32, -20°C up to +65°C, EN54-11
ARA132-RED	Remote actuator electric, red, IP32, -20°C up to +65°C, EN54-11
ARA132-YEL-IP67	Remote actuator electric, yellow, IP67, -20°C up to +70°C, EN
ARA132-BLU-IP67	Remote actuator electric, blue, IP67, -20°C up to +70°C, EN
ARA132-RED-IP67	Remote actuator electric, red, IP67, -20°C up to +70°C, EN
ARC113	Remote cover plastic for remote electric actuators against accidental activation for ARA113-YEL, ARA113-BLU, ARA113-RED
ARK113	Remote reset key spare for ARA113-YEL, ARA113-BLU, ARA113-RED

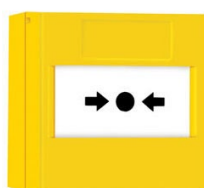

ARA132-YEL

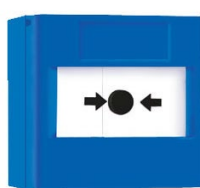

ARA132-BLU



ARA132-RED



ARA132-YEL-IP67



ARA132-BLU-IP67



ARA132-RED-IP67



ARC113



ARK113

ANNEX 2: PRESSURE MONITORING

A2.1. PRESSURE TRANSDUCER ATA100

Pressure Transducer ATA100 provides full range constant pressure monitoring in the system. It can identify a low pressure or overpressure in the system and notify the operator through an Alarm Panel or other external device.

Depending on the valve type, the Pressure Transducer ATA100 can be installed to the system in several ways described in Chapter [A2.4](#).

Table 65: Specifications of pressure transducer ATA100

Parameter	Description
Material of body	stainless steel
Pressure range	0 – 40 bar
Accuracy	0.5 % BFSL
Maximum overpressure	80 bar
Operation voltage	8 – 30 V DC
Power consumption	8 mA
IP rating	IP67
Operation temperature	from -40 °C up to 70 °C
Thread	M10x1 (14 mm with O-ring and filter)
Electrical cable	25 cm length, 3 x 0.75 mm ²



Pressure Transducer ATA100

A2.2. PRESSURE SWITCH APS001-xx

Pressure Switch APS001-xx is a mechanical switch with one pre-set pressure value (switch point). When the pressure in the system drops below the switch point the pressure switch sends a signal to an Alarm Panel or an external device to perform the operation. The pressure switch is supplied with a cable connector.

The Pressure Switch APS001-xx will send a signal when the pressure in the system decreases regardless of the cause, in case of fire or accidental activation and rapid decrease of pressure in the system which is below the pre-set value.

Depending on the valve type, the Pressure Switch APS001 can be installed to the system in several ways described in see Chapter [A2.4](#).

Table 66: Specifications of pressure switch APS001-xx

Parameter	Description		
Material of body	galvanised steel		
Switch configuration	N/O or N/C		
Hysteresis	min. 0.5 bar, max. 1.5 bar		
Switching frequency	max. 100 min-1		
Power rating	Voltage	Current	
Resistive load AC-12, DC12	AC 250 V	DC 24 V	4 A
Inductive load AC-14, DC14	AC 250 V	DC 24 V	2 A
IP rating	IP65 with cable connector and seal		
Electrical outlet	DIN EN 175301-803 A		
Operation temperature	from -30 °C up to 100 °C		
Thread	M10x1 (12.5 mm with O-ring and filter)		



Pressure Switch APS001-xx

Table 67: Versions of APS001-xx for 25 bar systems with powder agent

Suitable for	Switch point	Pressure value	Part No
25 bar powder	Fire indication	17	APS001-17
25 bar powder	Low pressure	19	APS001-19

APS001 has a selectable switching function, so it can be set to normally open (N/O) or normally closed (N/C) state.

IMPORTANT

Normal state is at atmospheric pressure (e.g., unpressurised system or system after extinguishing).

1. Connector for N/C circuit – for sending signal to an alarm panel, switching on devices (sirens, beacons) or switching off devices using an external relay
2. Connector for N/O circuit – for switching off connected devices (e.g., ventilation, that is connected in the electric circuit)
3. COM connector
4. ground connector

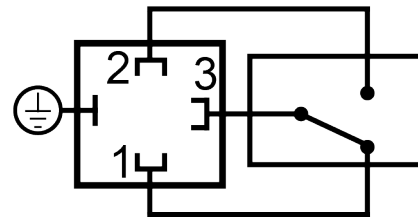

APS001 connector

A2.3. PRESSURE SWITCH APS003-xx

Pressure Switch APS003-xx is a mechanical switch with one pre-set pressure value (switch point). When the pressure in the system drops below the switch point, the pressure switch sends a signal to an Alarm Panel or an external device to perform the operation. The pressure switch is supplied with a cable connector.

The Pressure Switch APS003 will send a signal when the pressure in the system decreases regardless of the cause, in case of fire or accidental activation and rapid decrease of pressure in the system which is below the pre-set value.

Depending on the valve type, the Pressure Switch APS003 can be installed to the system in several ways described in Chapter [A2.4](#).

Table 68: Specifications of pressure switch APS003

Parameter	Description
Material of body	brass
Switch configuration	N/C
Hysteresis	min. 0.5 bar, max. 1.5 bar
Voltage	42 V DC / 100 V AC
Current	max 4 A
IP rating	IP65 with cable connector and seal
Electrical outlet	DIN 43650A
Operation temperature	from -40 °C up to 100 °C
Thread	M10x1 (12.5 mm with O-ring and filter)



Pressure Switch APS003

Table 69: Versions of APS003-xx for 25 bar systems with powder agent

Suitable for	Switch point	Pressure value	Part No
25 bar powder	Fire indication	17	APS003-17
25 bar powder	Low pressure	19	APS003-19

APS003 has a set switching position to normally closed (N/C) state.

IMPORTANT

Normal state is at atmospheric pressure (e.g., unpressurised system, system after extinguishing).

1. Connector for N/C circuit – for sending signal to an alarm panel, switching on devices (sirens, beacons) or switching off devices using an external relay
2. COM connector
3. not used
4. ground connector

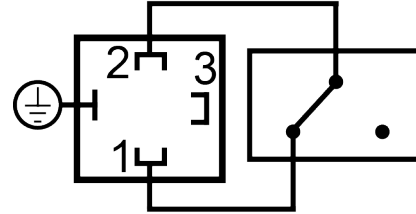

APS003 connector

A2.4. INSTALLATION OF THE PRESSURE MONITORING COMPONENTS

Pressure monitoring components such as pressure transducers, pressure switches and additional pressure gauges are usually delivered not installed, to prevent them from damaging during transportation. All pressure monitoring components are compatible with M10x1 ports. The M10x1 ports are sealed by a Schrader valve, which closes and opens automatically during removal or installation of the components. The same principle of sealing is also used on end-of-line adapters and M10x1 adapter FVABM0210 on the cylinder valve.

At the time of order, a valve adapter FVABM0210 can be requested to allow for additional M10x1 port for pressure monitoring components.

Suitable ports for individual components:

1. first M10x1 port on the cylinder valve
 - a) main pressure gauge
 - b) Pressure Transducer ATA100
 - c) Pressure Switch APS001 (version for monitoring low pressure recommended)
2. second M10x1 port on the cylinder valve
 - a) main pressure gauge
 - b) Pressure Transducer ATA100
 - c) Pressure Switch APS001 (version for monitoring low pressure recommended)
3. front Valve Adapter FVABM0210 (optional component)
 - a) Pressure Switch APS001 (version for fire indication recommended)
4. back Valve Adapter FVABM0210 (optional component)
 - a) Pressure Switch APS001 (version for fire indication recommended)
5. End-of-line Adapter AEA006 on a BlazeTube
 - a) additional pressure gauge
 - b) Pressure Transducer ATA100
 - c) Pressure Switch APS001 (version for fire indication recommended)
6. Pneumatic Manual Actuator ARA010 or ARA020 (see ANNEX 3 or ANNEX 4)
 - a) additional pressure gauge (comes installed as standard on ARA010 and ARA020)

IMPORTANT!

Main pressure gauge must always be installed in the appropriate port on the cylinder valve. It can be uninstalled only momentarily, during maintenance or gauge relocation, when the system is unpressurised.

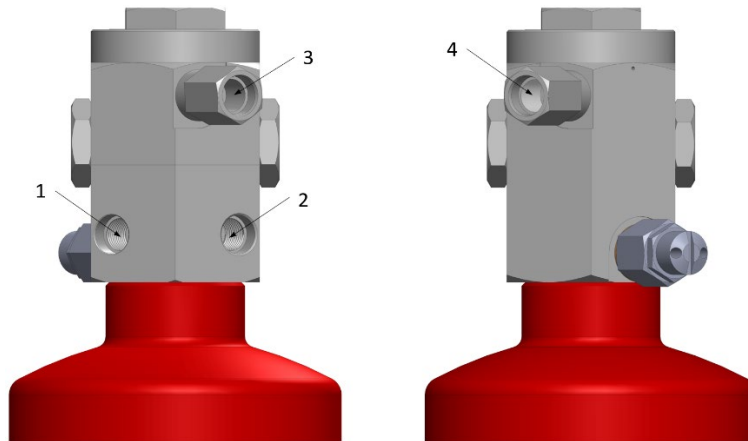

All M10x1 ports on front (left picture) and back (right picture) of a cylinder valve

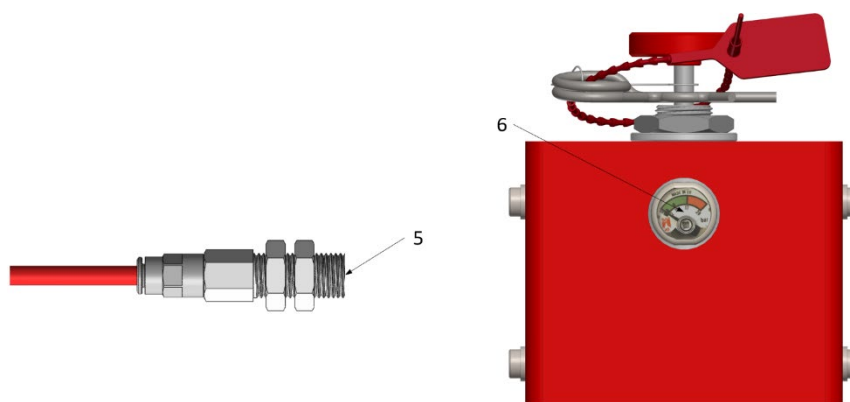

Additional M10x1 ports on external components

NOTE

In case of malfunction or disconnection of the pressure monitoring components (Pressure Switch APS001, Pressure Transducer ATA100) the system remains functional. These components are not necessary for its automatic activation in case of fire.

A2.4.1. WARNINGS



Don't use the M10x1 port with the mounted pressure gauge on the cylinder valve. By removing the pressure gauge from the valve when the system is pressurised, a small amount of agent can be released into the port and damage the integrated Schrader valve, causing a pressure leak.



When uninstalling components from the bottom M10x1 ports on the cylinder valve, the system must be depressurised beforehand. Not doing so can lead to release of a small amount of agent into the port and damage the integrated Schrader valve, causing a pressure leak.



If the system is in operation and the BlazeTube detection under pressure, when mounting and dismantling a pressure monitoring component at the end-of-line device, the ball valve on the cylinder valve must be closed, to avoid a false actuation.



Install the pressure switch and pressure transducer so that it is not exposed to aggressive chemical substances (caustic, acids, solvents, corrosive substances etc.) and to direct influence of weather conditions.



Always place the pressure switch in the lower part of the risk area to avoid direct flames and heat. The pressure switch cannot be in direct contact or be in immediate proximity with parts which heat to temperatures of more than 80 °C (176 °F) e.g., engine block, engine turbocharger, exhaust pipe, heated parts of inductors etc.



Be aware of the danger posed by the protected device. When working in the vicinity of electrical equipment observe corresponding safety rules and instructions. Work on electrical installations may be performed only by qualified persons.

When unscrewing a plug or a component from the M10x1 ports, do it right before installation of the new component, in order to prevent dirt from getting into the outlet. To properly install the components and prevent any malfunctions of the system, screw in the components tightly and check for presence of any leaks.

In case a pressure transducer, pressure switch or a pressure gauge has to be uninstalled from any of the bottom M10x1 ports on the cylinder valve, depressurisation of the cylinder has to be done beforehand. Follow these steps when installing or uninstalling components into the cylinder valve:

1. Uninstall (fully unscrew) the desired component. A small amount of extinguishing powder may be released from the outlet.
2. Release pressure from the cylinder by gently pushing in the Schrader valve in the freed port (shown by arrows on the picture below)
3. Clean up the whole port, mainly the sealing surfaces (green area on the picture) on the cylinder valve with a clean dry cloth or a brush.
4. Install the new component or seal the outlet with a FVP1M10 plug
5. Pressurise the system as described in Chapter [8.3](#).

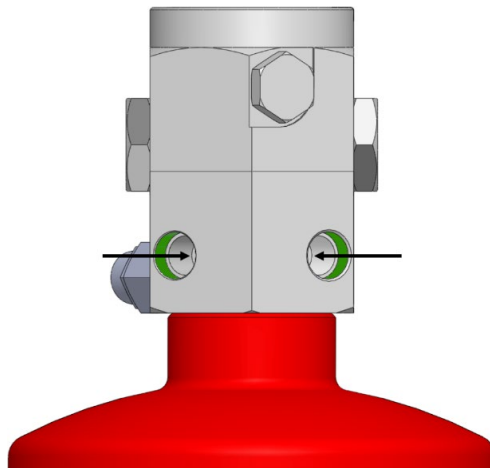

Bottom M10x1 ports with exposed Schrader valves after component uninstallation

A2.5. ELECTRICAL CABLES AND CONDUITS

For installation of electrical components use the appropriate electrical cables supplied as optional components:

- solenoid – two core electrical cable,
- Pressure Transducer ATA100 – two core electrical cable;
- Pressure Switch APS001-xx or APS003-xx – two, three or four core electrical cable.

Table 70: Specifications of cables

Part No	Description	Comment	Length
ASC002	standard cable, 2x0.75 mm ² , -40°C up to 80 °C, UV stabilized	for standard installations	per metre
ASC004	standard cable 4x0.5 mm ² , -40°C up to 80 °C, UV stabilized	for standard installations	per metre
ASC008	standard cable 8x0.5 mm ² , -40°C up to 80 °C, UV stabilized	for standard installations	per metre
ASC010	standard cable 10x0.5 mm ² , -40°C up to 80 °C, UV stabilized	for standard installations	per metre
ASC102	silicone cable 2x0.75 mm ² , -60 °C up to 180 °C, UV stabilized, up to 500 V	for installations with high temperatures like in engine compartments	per metre
ASC103	silicone cable 3x0.50 mm ² , -60 °C up to 180 °C, UV stabilized, up to 500 V	for installations with high temperatures like in engine compartments	per metre
ASC104	silicone cable 4x0.50 mm ² , -60 °C up to 180 °C, UV stabilized, up to 500 V	for installations with high temperatures like in engine compartments	per metre



Standard cable



Silicone cable

Table 71: Silicone cable kits

Part No	Description
KASC102-005	2-core Silicone cable kit, 5 metres, 15 cable ties, -60 °C up to 180 °C
KASC102-010	2-core Silicone cable kit, 10 metres, 30 cable ties, -60 °C up to 180 °C
KASC102-015	2-core Silicone cable kit, 15 metres, 45 cable ties, -60 °C up to 180 °C
KASC102-020	2-core Silicone cable kit, 20 metres, 55 cable ties, -60 °C up to 180 °C
KASC103-005	3-core Silicone cable kit, 5 metres, 15 cable ties, -60 °C up to 180 °C
KASC103-010	3-core Silicone cable kit, 10 metres, 30 cable ties, -60 °C up to 180 °C
KASC103-015	3-core Silicone cable kit, 15 metres, 45 cable ties, -60 °C up to 180 °C
KASC103-020	3-core Silicone cable kit, 20 metres, 55 cable ties, -60 °C up to 180 °C
KASC104-005	4-core Silicone cable kit, 5 metres, 15 cable ties, -60 °C up to 180 °C
KASC104-010	4-core Silicone cable kit, 10 metres, 30 cable ties, -60 °C up to 180 °C
KASC104-015	4-core Silicone cable kit, 15 metres, 45 cable ties, -60 °C up to 180 °C
KASC104-020	4-core Silicone cable kit, 20 metres, 55 cable ties, -60 °C up to 180 °C

In case of installation in spaces with increased risk of damage due to mechanical interference use the cable conduit with conduit connector to protect the electrical cables.

Table 72: Specifications of conduits

Part No	Description	Length
ACC110	internal Ø 10 mm, -40 °C to 120 °C, UV stabilized	per metre



Cable conduit ACC110

Table 73: Specifications of electrical connectors

Part No	Description	Working temperature
ADC002	2-pin Deutsch connector	-55 °C to +125 °C
ADC003	3-pin Deutsch connector	
ADC004	4-pin Deutsch connector	
ADC006	6-pin Deutsch connector	
ADC008	8-pin Deutsch connector	
ADC012	12-pin Deutsch connector	



ADP001

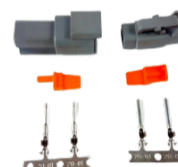

2-pin Deutsch connector

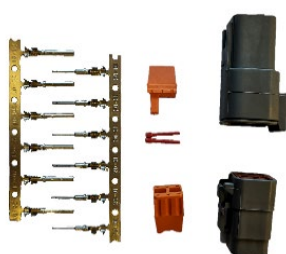

6-pin Deutsch connector

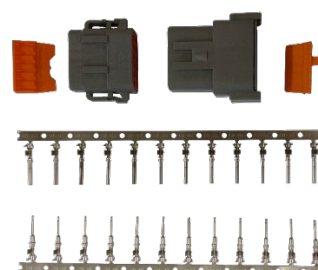

12-pin Deutsch connector

ANNEX 3: PNEUMATIC REMOTE ACTUATORS ARA010 AND ARA020

A3.1. BASIC INFORMATION ABOUT THE COMPONENTS

The remote pneumatic actuator is an optional component of the BlazeCut system. The actuator is using a unique double sealing mechanism on the internal shaft that keeps the pressure in the LOP line. It operates on the principle of manual release of pressure from the LOP line after breaking the seals when pressing the knob of the actuator. This results in opening of the piston of the cylinder valve, activating the suppression system and completely releasing the extinguishing agent. This is the same process as during disruption of the BlazeTube detection by effect of fire or heat. After activation, actuator's pin can be easily reset with no need to replace a burst disc or similar.

The pneumatic remote actuator serves as an end-of-line device and comes with an adaptor G1/8"to M10x1 with internal Schrader valve, which can also be used to pressurise the LOP line. The M10x1 port comes with installed pressure gauge as standard.

Any instructions in this manual regarding the end-of-line adapter apply to remote actuator of the system.



The pressure gauge used on the pneumatic remote actuator must be the same type as the gauge used on the pressure cylinder with the extinguishing agent connected to the same LOP line.



Do not press and pull the red knob with a sealing shaft installed in the actuator unless necessary. Excessive use may result in reduced sealing properties of the assembly.

Remote pneumatic actuator ARA010 and ARA020 work on the same principle and are built from the same components, in addition the ARA020 has comes with a protective steel cover.

Additional parts and replacement components for pneumatic remote actuator are listed in [Table 76](#).

Actuator material: stainless steel body, powder coated steel case.

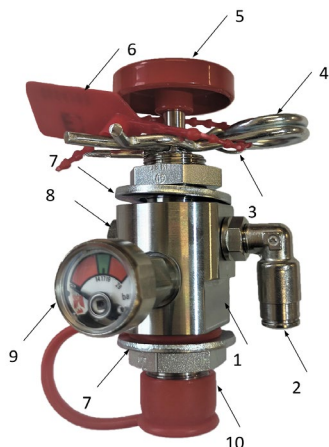

Remote pneumatic actuator bulk ARA010



Remote pneumatic actuator boxed ARA020

1. Body of the remote actuator
2. BlazeTube Connector FBT2BP026-A
3. Securing wire
4. Safety pin
5. Red knob with a label ALA009
6. Plastic lock seal ALS001
7. Mounting nut and washer
8. G1/8" outlet with a valve plug FVP1B02 as standard – can be ordered with different BlazeTube connectors for the side ports (see [Table 74](#))
9. Pressure gauge mounted on an adaptor FVABM0210
10. Dust cap on a vent

IMPORTANT!

Do not remove the dust cap (10.) from the actuator's body.

NOTE

* *When using a single pneumatic remote actuator on a LOP line, use standard configuration with one BlazeTube connector and the other outlet plugged. For serial connection of multiple actuators, occupy both outlets with BlazeTube connectors or use one Tee connector FBT3PBP6026-A.*

Table 74: Remote pneumatic actuator connectors

Part №	Description	Working temperature	Working pressure	Material
FBT1BP026-A	outlet connector for BlazeTube \varnothing 6 mm, G1/8"	-30 to +80 °C	0.9 – 60 bar	body and gripper: nickel-plated brass
FBT2BP026-A	elbow connector 360° rotation for BlazeTube \varnothing 6 mm, G1/8"			
FBT3PBP6026-A	Tee connector 360° rotation for BlazeTube, \varnothing 6 mm, G1/8"			seals: EPDM

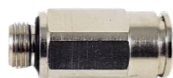

FBT1BP026-A



FBT2BP026-A











FBT3BP6026-A

Table 75: Recommended connector combinations for remote pneumatic actuators

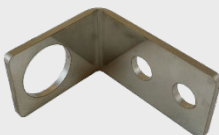
No	Suitable for	Left port	Right port	Connection type
1.	ARA010	FBT1BP026-A	FBT1BP026-A	passthrough
2.	ARA010	FBT1BP026-A	Plug	end-of-line
3.	ARA010	Plug	FBT1BP026-A	end-of-line
4.	ARA010	FBT1BP026-A	FBT2BP026-A	passthrough
5.	ARA010, ARA020	FBT2BP026-A	FBT2BP026-A	passthrough
6.	ARA010, ARA020	FBT2BP026-A	Plug	end-of-line
7.	ARA010, ARA020	Plug	FBT2BP026-A	end-of-line
8.	ARA010	FBT3BP6026-A	Plug	passthrough
9.	ARA010	Plug	FBT3BP6026-A	passthrough

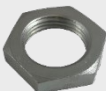
Table 76: Remote pneumatic actuator accessories

Part No	Description	Comment	Material
FVP1B02		Remote actuator side plug G1/8"	stainless steel sealing
ANC002		Cap for remote actuators ARA010/ARA020, -40°C to 180 °C, ID 17 mm	silicone
APR002		Safety pin for remote actuator	galvanized steel
ALS001		Lock seal for remote actuator and ball valve anti tamper security lock	plastic
ANB001		Bracket for firm fixing of remote actuator	stainless steel
AWR001		Flat washer for remote actuator and nozzle assembly, M20	galvanized steel
ANR001		Nut for remote actuator for bulkhead mounting, M20	galvanized steel

ALA009		Ø 33 mm label for remote actuator "PULL PIN FIRE STRIKE KNOB"	-
ALA010		90 x 80 mm label for pneumatic remote actuator box, includes 3 x overlay stickers for agents (foam, powder, gas) "In case of fire" <ul style="list-style-type: none"> • Remove safety pin • Strike knob firmly" 	-

A3.2. INSTALLATION OF THE REMOTE ACTUATOR

Always place the remote actuator in the proximity of the protected enclosure so that it is easily accessible when necessary. Do not place it in the area of expected fire, where manual activation after the fire has started, is not possible.

Label the remote actuator visibly with the corresponding label ALA007.

The pneumatic actuator ARA010 is suited for mounting onto a custom bracket, cover, dashboard or wall using the included fastening nuts and washers (see Chapter [A3.2.1](#)).

The pneumatic actuator ARA020 with a cover is suited to wall mounting through mounting holes. Use suitable and durable screws to firmly secure the cover for the manual actuator (see Chapter [A3.2.2](#)).

The BlazeTube detection is mounted onto the BlazeTube connector on the remote actuator by slotting into the outlet and pushed by hand all the way in. Always make sure after slotting that the tube is firmly fastened by pulling it gently. Follow all the provisions and instructions in Chapter [7.4](#).

A3.2.1. INSTALLATION OF ARA010

If the supplied configuration isn't convenient, it is possible to change the position of the BlazeTube connector or add an additional one in the place of the FVP1B02 plug. Just unscrew the plug FVP1B02 from the actuators body and screw in the chosen BlazeTube connector.

This operation has to be done before installation of the actuator to the desired location.

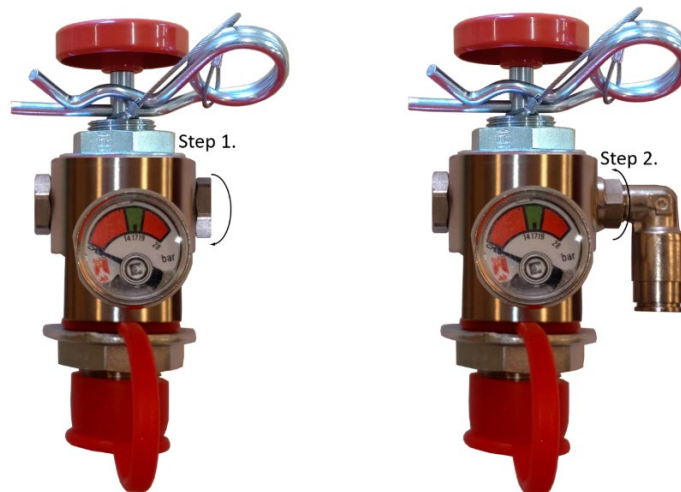

Step 1: Unscrew the plug FVP1B02 from the actuators body;

Step 2: Screw in the chosen connector for BlazeTube and tighten it with a 12 mm torque wrench to 10 Nm.

To install the actuator ARA010 onto a custom bracket, cover, wall etc., follow the installation figures below.

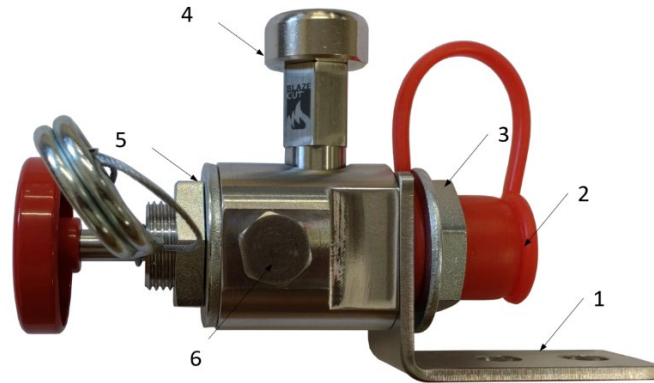

Pneumatic actuator ARA010 – back mounting

1. Bracket (e.g., ANB001) or a solid wall with a hole of \varnothing 21 mm
2. Dust cap ANC002
3. Nut with a washer – keep the order of components as shown on the figure
4. Pressure gauge – should be positioned so it is easy to read
5. Spare nut and washer – used for other mounting option
6. Plugged outlet for BlazeTube connector

IMPORTANT!

Before mounting in the following position, partial disassembly is required. For the assembly and disassembly of the actuator do not use other tools than mentioned in the procedure, as they can damage functional surfaces of the components.

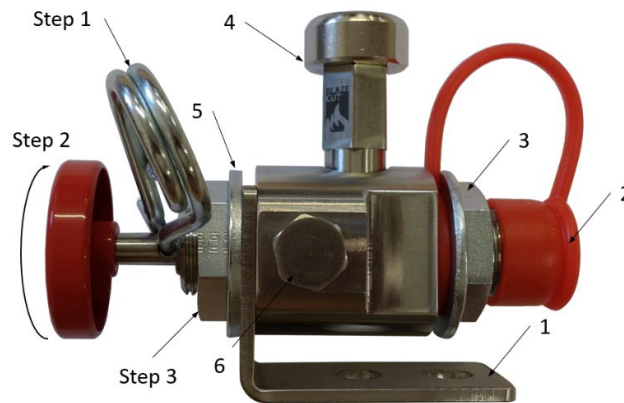

Pneumatic actuator ARA010 – front mounting

1. Bracket (e.g., ANB001) or a solid wall with a hole of \varnothing 21 mm
2. Nut with a washer – keep the order of components as shown on the figure
3. Nut and washer for the dust cap fixture
4. Pressure gauge
5. BlazeTube connector

Step 1: Put your finger into the safety pin, to use it as a lever;

Step 2: Grab the red knob with hand and unscrew it;

Step 3: Remove the safety pin, securing wire, nut and washer;

Step 4: Install the actuator to the bracket;

Step 5: Reinstall the washer and nut, and tighten them with a 27 mm spanner;

Step 6: Reinstall the securing wire and safety pin;

Step 7: Put your finger into the safety pin, grab the red knob with hand and screw it on the shaft;

Step 8: Install the bundled plastic lock seal ALS001.

A3.2.2. INSTALLATION OF ARA020

ARA020 is designed for a wall mount installations, for fixed installations in interior to mobile equipment in harsh environment due to its robust construction and stainless-steel materials.

Before installation of the actuator to the desired location, partial disassembly is required.

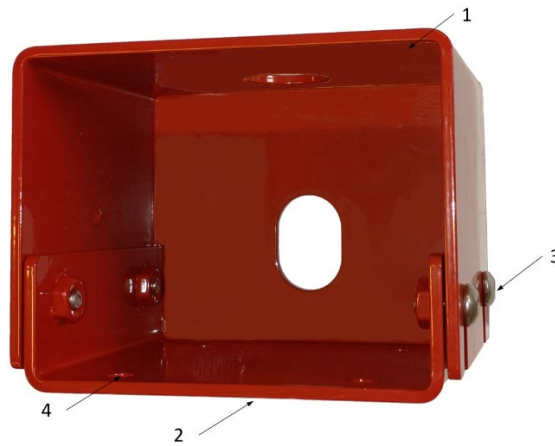

Steel cover of the Actuator ARA020

1. Top cover
2. Bottom cover
3. Fasteners for the cover
4. Mounting holes \varnothing 7 mm (mounting screws are not included)

IMPORTANT!

When following Step 3, Step 4 and Step 5, for assembly or disassembly, do not use any tools as they can damage functional surfaces of the components.

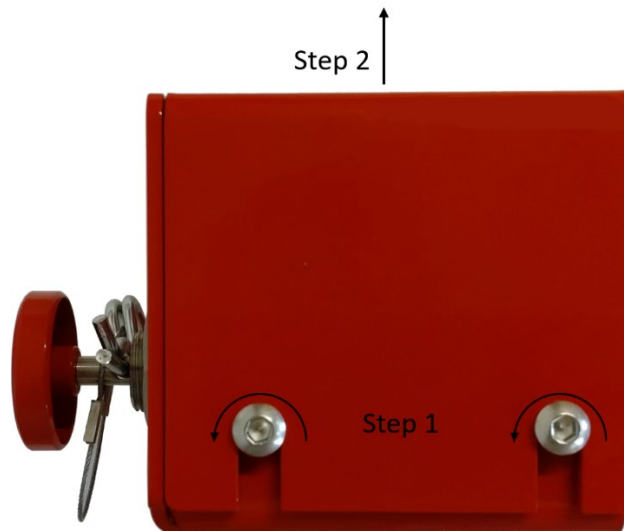

Step 1: Loosen the four screws on the actuator steel cover;

Step 2: Remove the top cover;

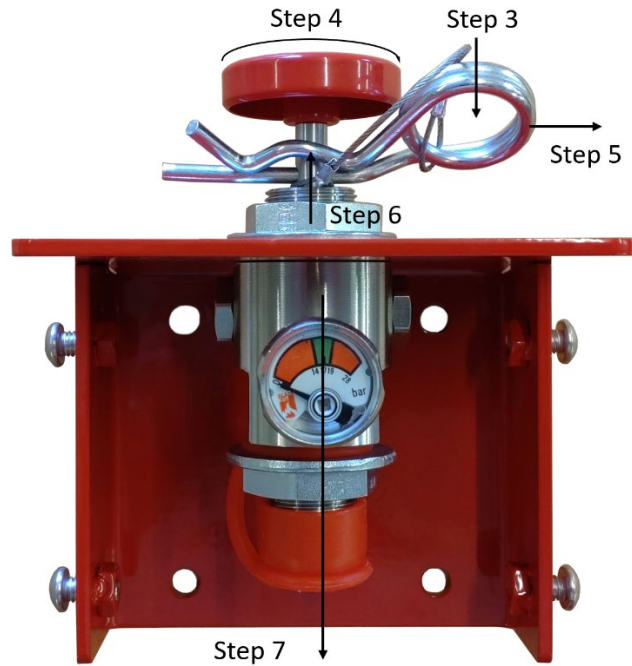

- Step 3: Put your finger into the safety pin, to use it as a lever;
- Step 4: Grab the red knob with hand and unscrew it;
- Step 5: Remove the safety pin and securing wire;
- Step 6: Remove the nut and the washer;
- Step 7: Take out the actuator body from the cover;

NOTE

Steps 8 and 9 are not necessary if configuration supplied is satisfactory.

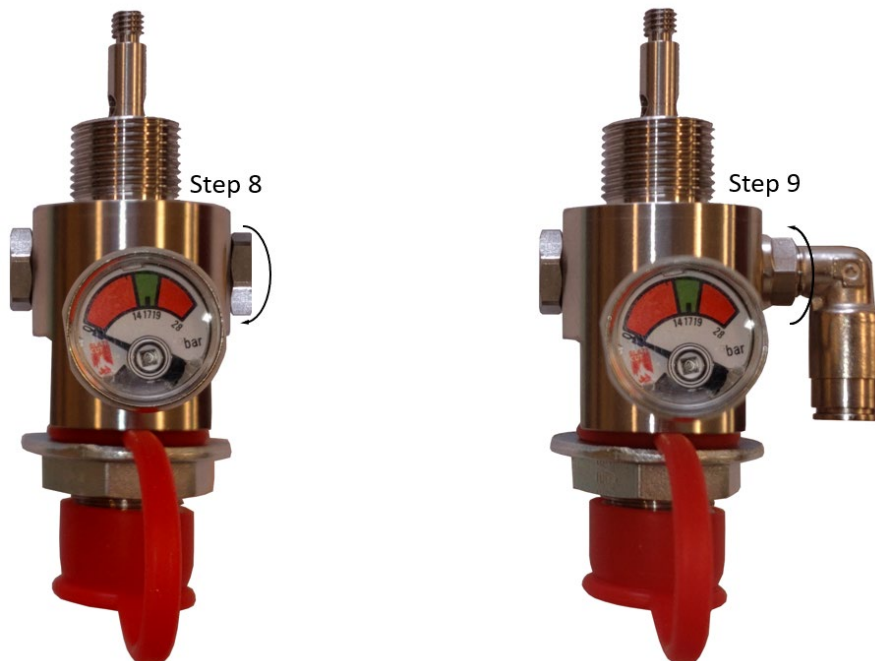

- Step 8: Unscrew the plug FVP1B02 from the actuators body with 14 mm spanner;
- Step 9: Screw in the chosen connector for BlazeTube and tighten it with a 12 mm torque wrench to 10 Nm;
- Step 10: Make holes to the wall on the desired location, following the pattern on the bottom cover;
- Step 11: Secure the bottom cover to the wall (mounting screws are not included);

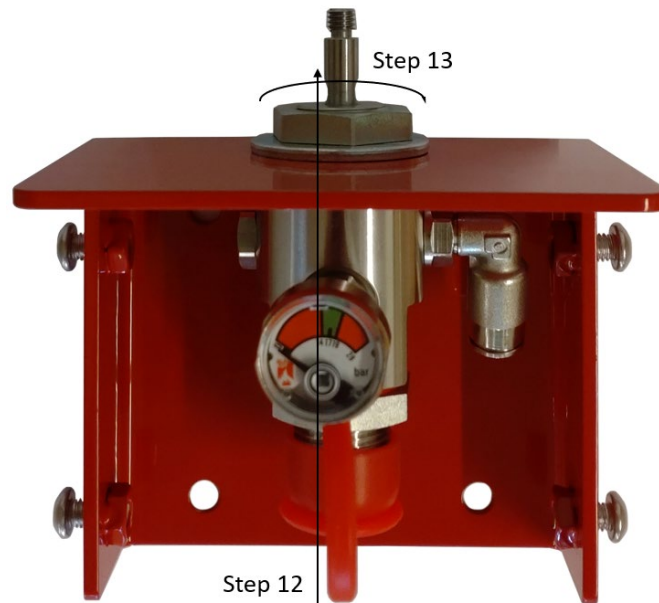

- Step 12: Put the actuator body back to the cover;
- Step 13: Reinstall the washer and nut, and tighten them with a 27 mm spanner
- Step 14: Reinstall the securing wire and safety pin;
- Step 15: Put your finger into the safety pin, grab the red knob with hand and screw it on the shaft;
- Step 16: Put on the top cover and tighten the for screw on the cover;
- Step 17: Install the bundled plastic lock seal ALS001.

A3.2.3. INSTALLATION OF ARA010 OR ARA020 INTO A SYSTEM

The remote pneumatic actuator can be installed in several ways to work in the desired configuration. It can be installed as an end-of-line device, or in between the end-of-line device and the cylinder valve. Using multiple actuators in series and combination of ARA010 with ARA020 is possible.

Table 77: Remote pneumatic actuator configurations

Configuration №	Valve type	Number of LOP lines	Number of pneumatic actuators	Method of connection between pneumatic actuators
1.	20x	1	1	-
2.	20x	2	1	-
3.	20x	1	2	serial
4.	20x	2	2	separate
5.	21x-01	1	1	-
6.	21x-01	1	2	serial
7.	21x-01	2	2	separate

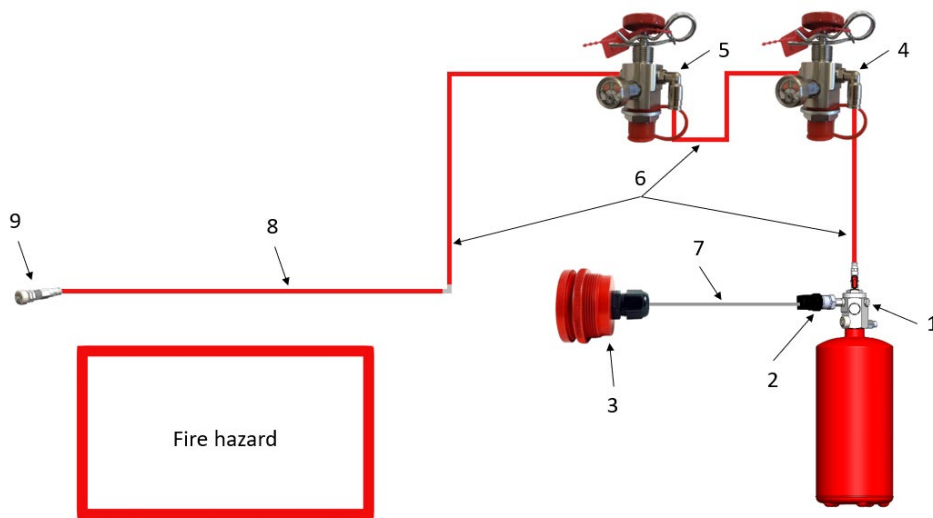

Configuration № 3 of a detection system with pneumatic actuators

1. BlazeCut C Series system with 20x valve
2. Pressure Switch APS001/Pressure Transducer ATA100
3. Alarm panel AAP210
4. Pneumatic actuator ARA010 or ARA020
5. Optional secondary Pneumatic actuator ARA010 or ARA020
6. BlazeTube and BlazeTube connectors outside the fire hazard area
7. Electrical cable
8. BlazeTube monitoring the fire hazard
9. End-of-line adapter AEA006 or Pneumatic actuators ARA010 or ARA020



A3.3. ACTIVATION OF THE REMOTE ACTUATOR

The remote actuator activates the system by releasing pressure from the LOP line after breaking the seals maintaining pressure in the LOP line when pressing the knob of the actuator. Description of the activation is shown on the figure below.



Procedure of manual activation





- Step 1: Firmly pull the safety pin and tear the plastic lock seal;
Step 2: Strike the red knob.

-  Do not manually activate the system without reason. Use manual activation only in case of reasonable suspicion of fire in the protected enclosure.
-  Do not manually activate the system if persons are present in the protected enclosures.
-  If the system is activated wait for its activity to finish. Do not enter the protected enclosures and do not open the covers of the protected enclosure during the activity of the system.

A3.4. PRESSURISATION OF THE LOP LINE

Pressurisation can be performed through the pneumatic remote actuator on end of the BlazeTube detection using a charging adapter ATC001. The pneumatic remote actuator has an outlet with thread M10x1 and contain a Schrader valve.

This valve closes and opens automatically during removal or installation of the charging adapter or the pressure gauge. It is possible to install and remove these components even when the tube is under pressure.

-  Proceed carefully and strictly follow the following steps. Fasten the connectors of the tubes, charging adapter and BlazeTube detection firmly and inspect. Their accidental disconnecting during pressurisation would release the extinguishing agent into the system.
-  Never connect or disconnect the charging adapter to the BlazeTube detection if the ball valve of the outlet of the BlazeTube detection on the cylinder valve is open.
-  Due to risk of activation during pressurisation of the system it is necessary to seal the outlets of the discharge networks on the cylinder valve. Remove the discharge networks and seal the outlets with the G3/8" valve plugs.
-  Pressurise the BlazeTube detection correctly. If the pressure in it is lower than in the cylinder, the valve piston of the cylinder could open and extinguishing agent could be released when opening the ball valve.

A3.4.1. PRESSURISATION PROCEDURE OF THE CYLINDER AND THE DETECTION SYSTEM – VALVES 201, 202, 211-01, 212-01 THROUGH THE REMOTE ACTUATOR

Proceed according to instructions in this chapter to pressurise the cylinder and BlazeTube detection at once.

For pressurisation of the LOP line only, skip **Step 6** and **Step 7**.

Step 1:

Make sure that the discharge ports are plugged with valve plugs FVP1B06, to avoid loss of agent in case of an accidental discharge when pressurising.

Make sure that the ball valve on the cylinder valve is closed

Read and write down the value of pressure from the cylinder valve.



Valve 201 (left) and valve 211-01 (right) with plugged ports and closed ball valves

Step 2:

Remove the pressure gauge from the charging port of the remote actuator.

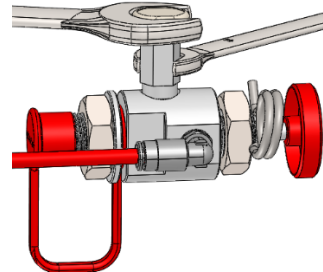

Step 3:

Make sure the ball valve on the charging adapter is closed.

Mount by hand the charging adapter ATC001 to the remote actuator's M10x1 port by rotating clockwise. Tighten the adapter properly.

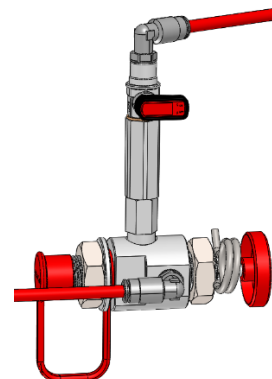

AUTOMATIC FIRE SUPPRESSION SYSTEMS



Step 4:

Set the regulator on the source of N₂ to the desired value (**25 bar at 20 ± 3 °C ambient temperature**). Setting must be at least 1 bar higher than the pressure in the cylinder. Graph of relationship between temperature and pressure in the cylinder is shown in Chapter 4.1. Open the regulator valve.



Step 5:

Slowly open the ball valve of the charging adapter and pressurise the LOP line first.

During pressurisation hissing can be heard. When the sound stops, pressurisation is finished. Keep the ball valve open for at least 30 seconds to stabilize the pressure in the LOP line.

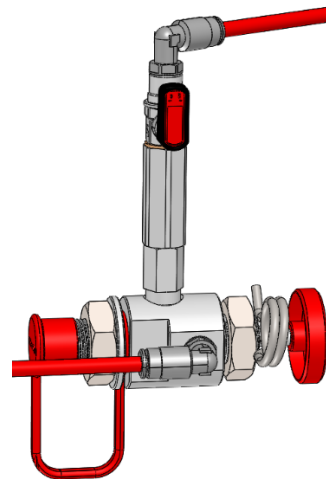

Step 6 (skip if pressurising only the LOP line):

Slowly open the ball valve on the cylinder valve and pressurise the cylinder.

During pressurisation hissing can be heard. When the hissing stops, keep the valve open for at least 30 seconds to stabilize the pressure.

Close the ball valve on the cylinder valve, shake the cylinder several times and repeat Step 6 until the pressure stabilises at the desired value.

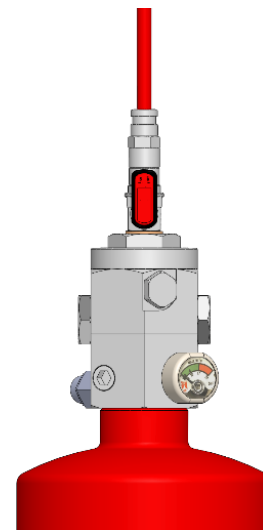

Step 7 (skip if pressurising only the LOP line):

Close the ball valve on the cylinder valve.

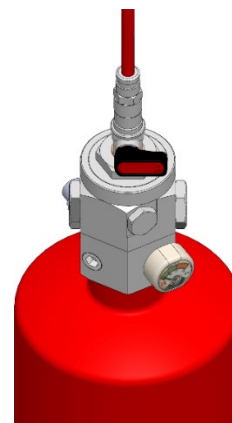

Step 8:

Close the ball valve on the charging adapter.

Step 9:

Unscrew the charging adapter from the M10x1 port of the remote actuator (with size 16 spanner). You can use size 14 spanner on the valve adapter to push clockwise while unscrewing the charging adapter.

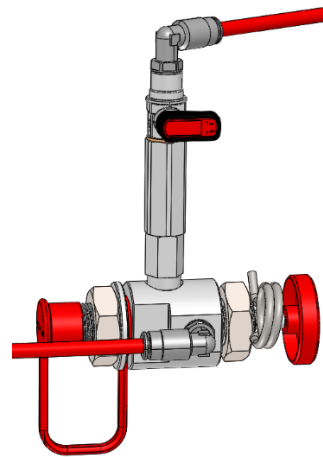

Step 10:

Mount the pressure gauge back. Tighten it with spanner 22 mm.

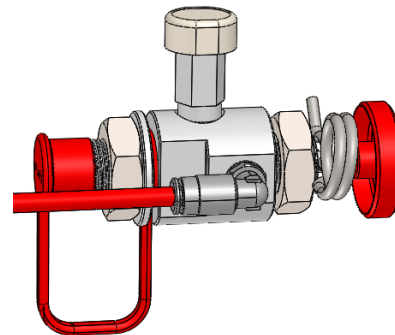

Step 11:

If the pressure is not decreasing, very slowly open the ball valve on the cylinder valve. Pressures in the tube and the cylinder will equalise. Wait approximately 30 seconds.

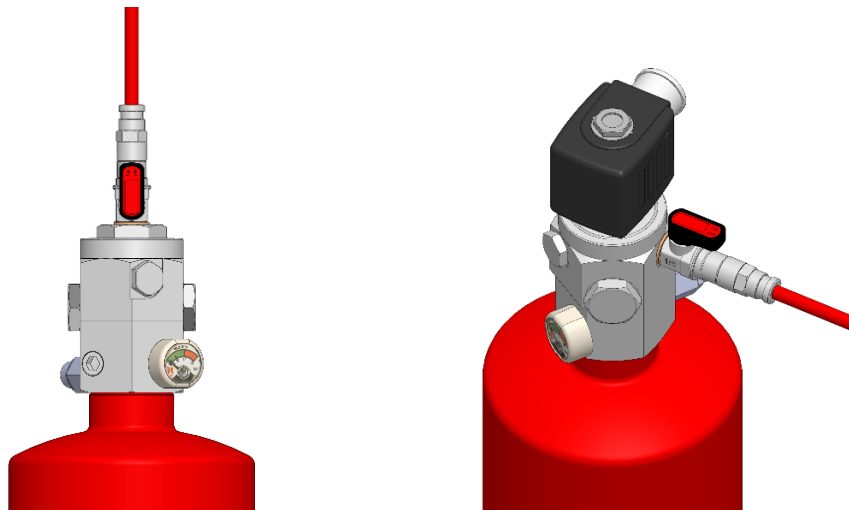

Valve 201 (left) and valve 211-01 (right) with plugged ports and opened ball valves

Follow additional steps from Chapter [7.5.3](#).



Since this moment the cylinder and the BlazeTube detection are connected in one pressure unit. Proceed carefully not to damage the BlazeTube detection. Its damage would cause activation of the system and release of extinguishing agent.



Do not try to remove the BlazeTube detection from the BlazeTube outlet on the cylinder valve or remove the end-of-line adapter if the BlazeTube is under pressure and the ball valve is open.



Fast and careless opening of the ball valve may activate the system and release extinguishing agent.

ANNEX 4: ELECTRIC REMOTE ACTUATORS ARA110 AND ARA120

A4.1. BASIC INFORMATION ABOUT THE COMPONENTS

The remote electric actuator is an optional component of the BlazeCut system. It operates on the principle of displacing a ball in a switch, which sends a signal to the solenoid on the cylinder valve, when pressing the knob of the actuator. This results in opening of the piston of the cylinder valve, activating the suppression system and completely releasing the extinguishing agent. This is the same process as during disruption of the BlazeWire (heat detector, smoke detector or heat probe) by effect of fire or heat.

Remote pneumatic actuator ARA110 and ARA120 work on the same principle and are built from the same components, in addition the ARA120 has comes with a protective steel cover.

Additional parts and replacement components for electric remote actuator are listed in [Table 78](#).

Actuator material: stainless steel body, powder coated steel case.

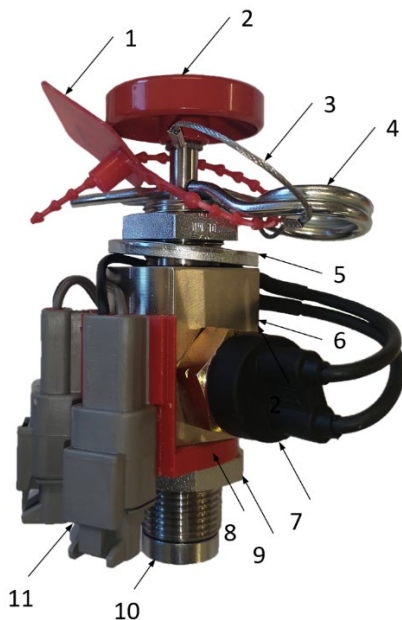







Remote electric actuator bulk ARA110

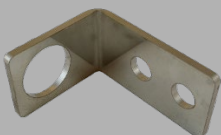

Remote electric actuator boxed ARA120

1. Plastic lock seal ALS001
2. Red knob
3. Securing wire
4. Safety pin
5. Mounting nut and washer
6. Body of the remote actuator
7. Ball switch
8. Connector holder
9. Securing nut for the connectors holder
10. Actuator plug FVP1B04
11. Electrical connectors

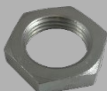
Table 78: Remote electric actuator accessories

Part No	Description	Comment	Material
APR002		Safety pin for remote actuator	galvanized steel
FVP1B04		Plug G1/4" for electric actuator ARA110, ARA120	galvanized steel, sealing
ALS001		Lock seal for remote actuator and ball valve anti tamper security lock	plastic
ANB001		Bracket for firm fixing of remote actuator	stainless steel
AWR001		Flat washer for remote actuator and nozzle assembly, M20	galvanized steel
ANR001		Nut for remote actuator for bulkhead mounting, M20	galvanized steel
ALA009		Ø 33 mm label for remote actuator "PULL PIN FIRE STRIKE KNOB"	
ALA011		90 x 80 mm label for electric remote actuator box, includes 3 x overlay stickers for agents (foam, powder, gas) "In case of fire" <ul style="list-style-type: none"> Remove safety pin Strike knob firmly" 	

A4.2. INSTALLATION OF THE REMOTE ACTUATOR

Always place the remote actuator in the proximity of the protected enclosure so that it is easily accessible when necessary. Do not place it in the area of expected fire, where manual activation after the fire has started, is not possible.

Label the remote actuator visibly with corresponding label ALA007.

The electric actuator ARA110 is suited for mounting onto a custom bracket, cover, dashboard or wall using the included fastening nuts and washers (see chapter [A4.2.1](#)).

The electric actuator ARA120 with a cover is suited to wall mounting through mounting holes. Use suitable and durable screws to firmly secure the cover for the manual actuator (see chapter [A4.2.2](#)).

A4.2.1. INSTALLATION OF ARA110

IMPORTANT!

Before mounting in the following position, partial disassembly is required. For the assembly and disassembly of the actuator do not use other tools than mentioned in the procedure, as they can damage functional surfaces of the components.

When mounting the actuator onto a custom bracket, cover, wall etc., follow the installation figures below.

Before mounting in the following position, partial disassembly is required. For the disassembly do not use any tools, as they can damage the surfaces of the components.

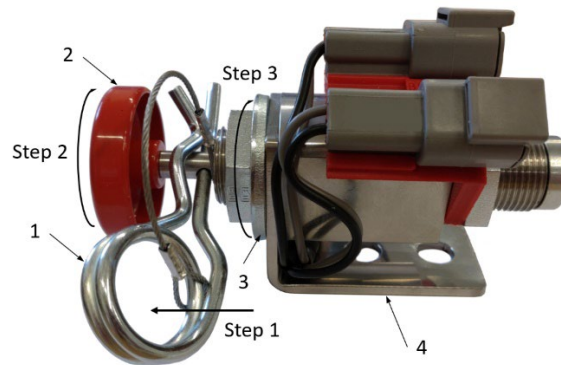

Electric actuator ARA110 – front mounting

6. Safety pin
7. Red knob
8. Nut and washer – keep the order of components as shown on the figure
9. Bracket (e.g., ANB001) or a solid wall with a hole of \varnothing 21 mm

Step 1: Put your finger into the safety pin, to use it as a lever;

Step 2: Grab the red knob with hand and unscrew it;

Step 3: Remove the safety pin, securing wire, nut and washer;

Step 4: Install the actuator to the bracket;

Step 5: Reinstall the washer and nut, and tighten them with a 27 mm spanner;

Step 6: Reinstall the securing wire and safety pin;

Step 7: Put your finger into the safety pin, grab the red knob with hand and screw it on the shaft;

Step 8: Install the bundled plastic lock seal ALS001.

A4.2.2. INSTALLATION OF ARA120

ARA120 is designed for a wall mount installations, for fixed installations in interior to mobile equipment in harsh environment due to its robust construction and stainless-steel materials.

Before installation of the actuator to the desired location, partial disassembly is required.

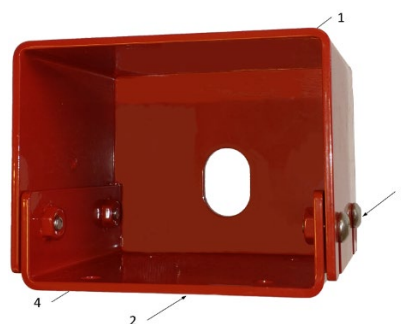

Steel cover of the Actuator ARA120

AUTOMATIC FIRE SUPPRESSION SYSTEMS



1. Top cover
2. Bottom cover
3. Fasteners for the cover
4. Mounting holes \varnothing 7 mm (mounting screws are not included)

IMPORTANT!

When following Step 3, Step 4 and Step 5, for assembly or disassembly, do not use any tools as they can damage functional surfaces of the components.

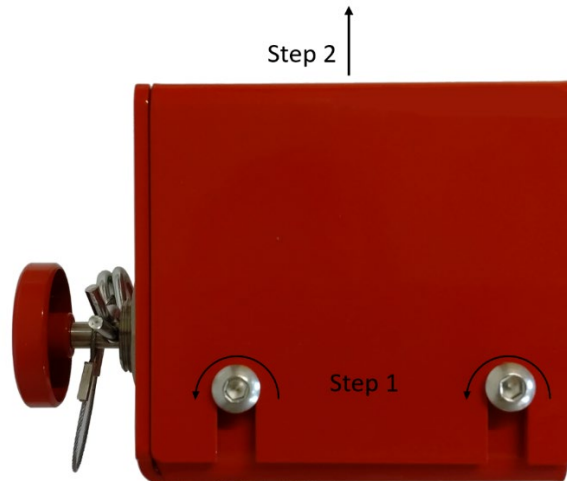

- Step 1: Loosen the four screws on the actuator steel cover;
Step 2: Remove the top cover;

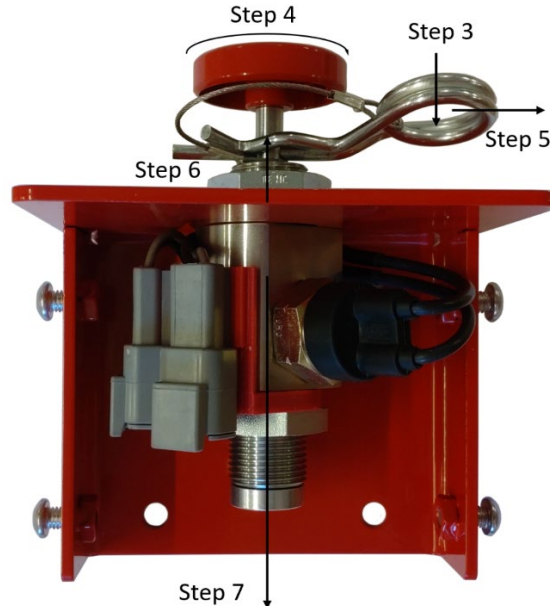

- Step 3: Put your finger into the safety pin, to use it as a lever;
Step 4: Grab the red knob with hand and unscrew it;
Step 5: Remove the safety pin and securing wire;
Step 6: Remove the nut and the washer;
Step 7: Take out the actuator body from the cover;
Step 8: Make holes to the wall on the desired location, following the pattern on the bottom cover;
Step 9: Secure the bottom cover to the wall (mounting screws are not included);

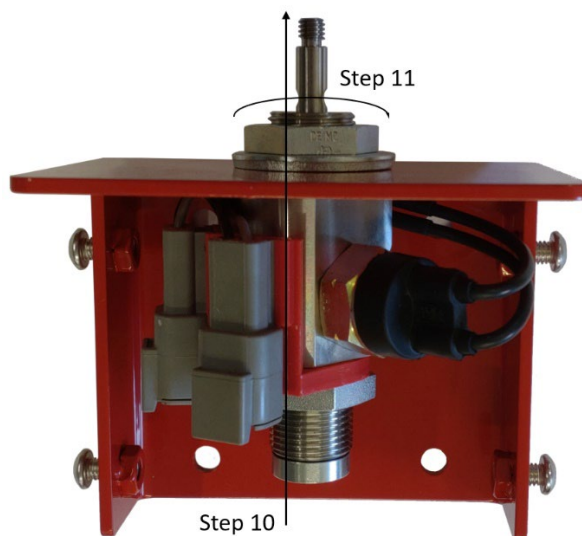

- Step 10: Put the actuator body back to the cover;
- Step 11: Reinstall the washer and nut, and tighten them with a 27 mm spanner
- Step 12: Reinstall the securing wire and safety pin;
- Step 13: Put your finger into the safety pin, grab the red knob with hand and screw it on the shaft;
- Step 14: Put on the top cover and tighten the for screw on the cover;
- Step 15: Install the bundled plastic lock seal ALS001.

A4.2.3. INSTALLATION OF ARA110 OR ARA120 INTO A SYSTEM

The remote electric actuator can be installed in several ways to work in the desired configuration. It can be installed at the end of the LHD line, or in between the end-of-line resistor and the cylinder valve. Using multiple actuators in series and combination of ARA110 with ARA120 is possible.

Table 79: Remote pneumatic actuator configurations

Configuration №	Valve type	Number of LHD lines or el. cables	Number of electric actuators	Method of connection between electric actuators
1.	21x	1	1	-
2.	21x	1	2	serial
3.	21x	2	2	separate

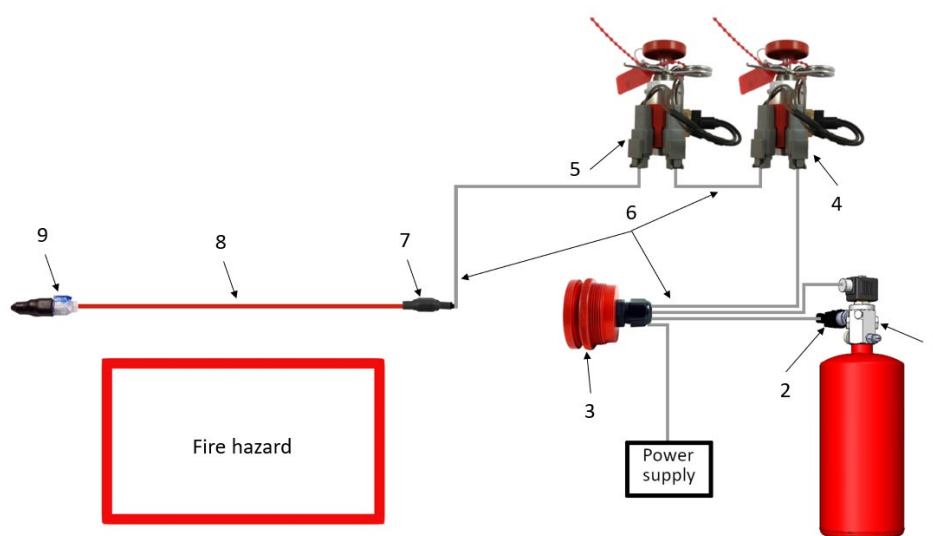

Configuration No 2 of a detection system with electric actuators

1. BlazeCut C Series system with 211 or 212 valve
2. Pressure Switch APS001/Pressure Transducer ATA100
3. Alarm panel
4. Electric actuator ARA110
5. Optional secondary Electric actuators ARA110 or ARA120
6. Electrical cable
7. Electrical splice AES3550-2
8. BlazeWire or detector
9. End-of-line resistor AER001

Other configuration options are possible. Contact your supplier of the BlazeCut system for more information.

A4.3. ACTIVATION OF THE REMOTE ACTUATOR

It operates on the principle of press/release of a ball in a ball switch, which sends a signal to the solenoid, when the strike knob is pressed. Description of the activation is shown on the figure below.



Procedure of manual activation

Step 1: Pull the safety pin from the actuator

Step 2: Strike the red knob



Do not manually activate the system without reason. Use manual activation only in case of reasonable suspicion of fire in the protected enclosure.



Do not manually activate the system if persons are present in the protected enclosures.



If the system is activated wait for its activity to finish. Do not enter the protected enclosures and do not open the covers of the protected enclosure during the activity of the system.

