

clarion®

Owner's manual

NX405E

**DVD MULTIMEDIA STATION WITH BUILT-IN NAVIGATION &
6.0" TOUCH PANEL CONTROL**

CAUTIONS:

This appliance contains a laser system and is classified as a "CLASS 1 LASER PRODUCT". To use this model properly, read this Owner's Manual carefully and keep this manual for your future reference. In case of any trouble with this player, please contact your nearest "AUTHORIZED service station".

To prevent direct exposure to the laser beam, do not try to open the enclosure.

OBS!

Apparaten innehåller laserkomponenten som avger laserstrålning överstigande gränsen för laserklass 1.

!CAUTION

USE OF CONTROLS OR ADJUSTMENTS OR PERFORMANCE OF PROCEDURES OTHER THAN THOSE SPECIFIED IN THE OWNER'S MANUAL MAY RESULT IN HAZARDOUS RADIATION EXPOSURE.

VAROITUS

Suojakoteloä si saa avata. Laitte sisältää laserdiodin, joka lähettää näkymätöntä silmille vaarallista lasersäteilyä.

ADVARSEL.

Denne mærkning er anbragt udvendigt på apparatet og indikerer, at apparatet arbejder med laserstråler af klasse 1, hvilket betyder, at der anvendes laserstråler af svageste klasse, og at man ikke på apparatets yderside kan blive udsat for utilsigelig kraftig stråling.

APPARATET BØR KUN ÅBNES AF FAGFOLK MED SÆRLIGT KENDSKAB TIL APPARATER MED LASERSTRÅLER!

Indvendigt i apparatet er anbragt den her gengivne advarselsmærkning, som advarer imod at foretage sådanne indgreb i apparatet, at man kan komme til at udsætte sig for laserstråling.

| | |
|---|-----------|
| 1. FEATURES | 4 |
| Expanding Systems..... | 4 |
| 2. PRECAUTIONS | 5 |
| 3. CAUTIONS ON HANDLING | 8 |
| Operation Panel..... | 8 |
| USB Port | 8 |
| Cleaning | 8 |
| Handling Discs | 9 |
| 4. OPERATION PANEL | 11 |
| Functions of Buttons..... | 11 |
| 5. REMOTE CONTROL | 12 |
| Remote Control Functions | 13 |
| 6. MAIN MENU | 15 |
| 7. DVD VIDEO PLAYER OPERATIONS | 16 |
| Discs | 16 |
| Change DVD System Settings..... | 17 |
| Watching to a Disc..... | 17 |
| Showing DVD Player Mode Screen | 18 |
| Operate the DVD Player Menu | 18 |
| Showing Video Files Player Mode Screen | 19 |
| Operate the Video Files Player Menu | 20 |
| Playable Video Disc Formats | 21 |
| 8. CD PLAYER OPERATIONS..... | 22 |
| Listening to a Disc/Ejecting a Disc..... | 22 |
| Showing CD Player Mode Screen | 22 |
| Operate the CD Player Menu..... | 22 |
| Listening to Compressed Audio | 23 |
| Tag Display Function | 23 |
| Playback MP3/WMA/AAC menu | 24 |
| 9. USB AUDIO OPERATIONS..... | 25 |
| Notes on Using USB Memories..... | 25 |
| Select USB Audio Mode..... | 25 |
| Playing Audio Files in USB Memory | 26 |
| 10. USB VIDEO OPERATIONS..... | 27 |
| Notes on Using USB Memories..... | 27 |
| Select USB Video Mode..... | 27 |
| Playing Video Files in USB Memory | 27 |
| Playable Video Format..... | 27 |
| 11. iPod OPERATIONS..... | 29 |
| Notes on Using iPod/iPhone..... | 29 |
| iPod Audio Menu Operations..... | 29 |
| iPod Audio ID3 Mode Screen | 29 |
| iPod Audio Playlist Mode Screen..... | 30 |
| iPod Audio List Mode Screen | 30 |
| iPod Audio Simple Control Mode Screen | 30 |
| iPod Video Menu Operations..... | 31 |
| iPod Video ID3 Mode Screen iPod Video Menu Operations | 31 |
| iPod Video List Mode Screen | 32 |
| iPod Video Simple Control Mode Screen..... | 32 |
| iPod Video Play Mode Screen | 32 |
| 12. Bluetooth® AUDIO PLAYER OPERATIONS..... | 34 |
| Selecting the Bluetooth Audio Mode | 34 |
| Bluetooth Audio Player Settings | 34 |

| | |
|---|-----------|
| Registering Your Bluetooth Audio Player (Pairing) | 34 |
| Selecting the Bluetooth Audio Player..... | 35 |
| Controlling the Bluetooth Audio Player | 35 |
| 13. Bluetooth® TELEPHONE OPERATIONS..... | 36 |
| Select the BT Phone Mode..... | 36 |
| Bluetooth Telephone Settings..... | 36 |
| Registering Your Cellular Phone (Pairing) | 37 |
| Select the Cellular Phone | 37 |
| Get the Phone Book Data..... | 37 |
| Telephone Operations | 37 |
| 14. TUNER OPERATIONS | 39 |
| 15. DAB OPERATIONS | 41 |
| 16. TV OPERATIONS | 43 |
| 17. HDMI MODE | 44 |
| Wire Connection of HDMI Mode Wire Connection of HDMI Mode | 44 |
| Select HDMI Source | 45 |
| 18. AUX..... | 46 |
| 19. CAMERA INPUT OPERATIONS | 46 |
| 20. REAR SOURCE OPERATIONS | 47 |
| DVD Video in Rear..... | 47 |
| DVD Video Rear Source Control Info Mode..... | 47 |
| DVD Video Rear Source Control Direct Mode | 47 |
| iPod Video in Rear | 48 |
| iPod Video Rear Source Control Play Mode | 48 |
| iPod Video Rear Source ID3 Mode..... | 48 |
| 21. SETTING OPERATIONS | 49 |
| General Setup Menu | 49 |
| Video Setup Menu..... | 49 |
| Audio Setup Menu..... | 50 |
| Navigation Setup Menu | 50 |
| Others Setup Menu | 50 |
| Set the Anti-Theft Code | 51 |
| 22. TROUBLESHOOTING..... | 52 |
| General | 52 |
| DVD Player | 52 |
| USB Device..... | 53 |
| Bluetooth..... | 53 |
| TFT Screen | 54 |
| 23. ERROR DISPLAY | 55 |
| DVD Player | 55 |
| 24. SPECIFICATIONS | 56 |
| 25. WIRE CONNECTION GUIDE | 58 |

1. FEATURES

- **FLAC (Free Lossless Audio Codec)**
- **Built-in Bluetooth® Handsfree (HFP) and Audio Streaming (A2DP & AVRCP)**
- **Front-Panel Auxiliary Input and 6ch RCA Output with Subwoofer Control**



Expanding Systems

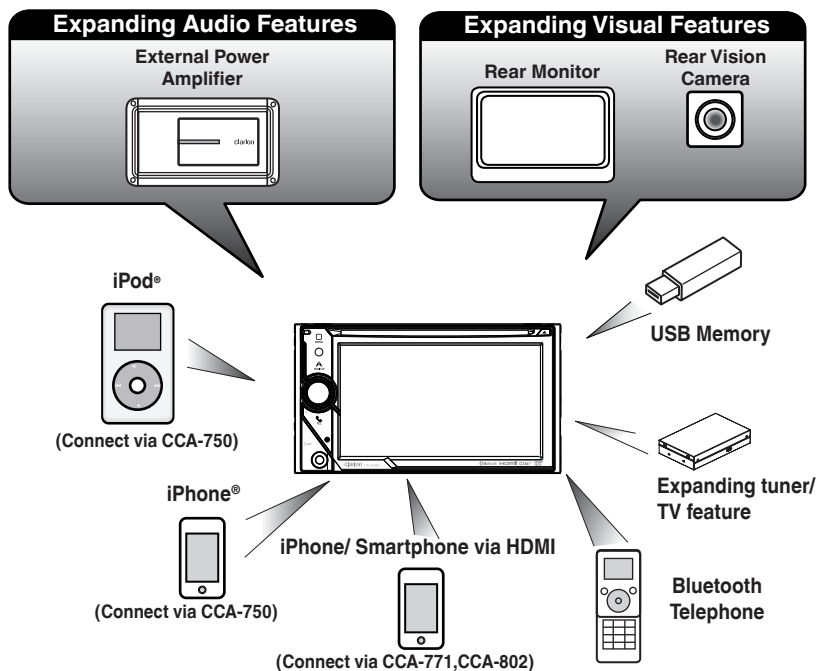

NOTE:

- The items listed outside of the frames are the commercial products generally sold.
- CCA-750, CCA-771, CCA-802: Sold separately.

2. PRECAUTIONS

WARNING

- For your safety, the driver should not watch any video sources and/or operate the controls while driving. Please note that watching and operating any video sources while driving are prohibited by law in some countries. Also, while driving, keep the volume to a level at which external sounds can be heard.
- Do not disassemble or modify this unit. It may cause an accident, fire, or electric shock.
- Do not use this unit when a trouble exists, such as no screen content appears or no sound is audible. It may cause an accident, fire, or electric shock. For that case, consult your authorized dealer or a nearest Clarion service center.
- In case of a problem, such as any material has been entered in the unit, the unit gets wet, or smoke or strange smells come out of the unit, etc., stop using this unit immediately, and consult your authorized dealer or a nearest Clarion service center.
Using it in that condition may cause an accident, fire, or electric shock.
- Use a fuse with the same specification only when replacing the fuse.
Using a fuse with a different specification may causes a fire.
- For the installation of this unit or a change in the installation, ask your authorized dealer or a nearest Clarion service center for safety. Professional skills and experiences are required to do so.
- This navigation system should not be used to replace your own judgment. No itinerary suggested by this navigation system should ever override any highway regulations, your own judgment, or a knowledge of safe driving practices. Do not follow the navigation system's suggested itinerary if it would cause you to perform a dangerous or illegal act, place you in a dangerous situation, or take you into an area you consider unsafe.
- The advice provided by the navigation system is to be regarded as a suggestion only. There may be times when the navigation system displays the vehicle's location incorrectly, fails to suggest the shortest route, or fails to direct you to your desired destination. In such instances, rely on your own driving judgment, taking into account the driving conditions at the time.
- Do not use the navigation system to locate emergency services. The database does not contain a complete listing of emergency services such as police stations, fire halls, hospitals and walk-in clinics. Please show discretion and ask for directions in such instances.
- As the driver, you alone are responsible for your driving safety.
- In order to avoid a traffic accident, do not operate the system while driving.
- In order to avoid a traffic accident, operate the system only when the vehicle is stopped at a safe place and the parking brake is on.
- In order to avoid a traffic accident or traffic offense, remember that actual road conditions and traffic regulations take precedence over the information contained on the navigation system.
- The software may contain inaccurate or incomplete information due to the passage of time, changing circumstances, and the sources of information used. Please respect current traffic conditions and regulations at all times while driving.
- Where actual road conditions and highway regulations differ from the information contained on the navigation system, abide by the highway regulations.
- Keep the amount of time spent viewing the screen while driving to a strict minimum.
- The navigation system does not provide, nor represent in any way information on: traffic and highway regulations; technical aspects of the vehicle including weight, height, width, load and speed limits; road conditions including grade, percentage of incline and surface conditions; obstacles such as the height and width of bridges and tunnels; and other current driving or road conditions. Always rely on your own judgment when driving a car, taking into account current driving conditions.

1. When the inside of the car is very cold and the player is used soon after switching on the heater, moisture may form on the disc (DVD/CD) or the optical parts of the player and proper playback may not be possible. If moisture forms on the disc (DVD/CD), wipe it off with a soft cloth. If moisture forms on the optical parts of the player, do not use the player for about one hour. The condensation will disappear naturally allowing normal operation.

2. Driving on extremely bumpy roads which cause severe vibration may cause the sound to skip.

3. This unit uses a precision mechanism. Even in the event that trouble arises, never open the case, disassemble the unit, or lubricate the rotating parts.

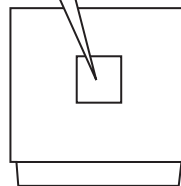

NX405E

3. CAUTIONS ON HANDLING

Operation Panel

For a longer service life, be sure to read the following cautions.

- The operation panel will operate properly in a temperature range of 0° to 60° C.
- Do not allow any liquids on the set from drinks, umbrellas etc. Doing so may damage the internal circuitry.
- Do not disassemble or modify the set in any way. Doing so may result in damage.
- Subjecting the operation panel to shocks may result in breakage, deformation or other damage.
- Do not let cigarettes burn the display.
- If a problem should occur, have the set inspected at your store of purchase.
- The remote control unit may not work if the remote control sensor is exposed to direct sunlight.
- In extremely cold weather, the display movement may slow down and the display may darken, but this is not a malfunction. The display will work normally when the temperature increases.
- Small black and shiny spots inside the liquid crystal panel are normal for LCD products.

USB Port

- The USB memory sticks must be recognized as "USB mass storage class" to work properly. Some models may not operate correctly.
When the memorized data is lost or damaged by any chance, Clarion shall not be liable for any damage.
- When using an USB memory stick, we recommend that you backup your data stored on it before by using a personal computer etc.
- Data files may be broken when using USB memory sticks in the following situation:
When disconnecting the USB memory stick or turning the power off during writing or reading data. When affected by static electricity or electric noise. Connect/disconnect the USB memory stick when it is not accessed.
- Connecting with the computer is not supported.
- Connecting with the USB Hub is not supported.

Cleaning

- **Cleaning the cabinet**
- Use a soft, dry cloth and gently wipe off the dirt. For tough dirt, apply some neutral detergent diluted in water to a soft cloth, wipe off the dirt gently, then wipe again with a dry cloth.
Do not use benzene, thinner, car cleaner, etc., as these substances may damage the cabinet or cause the paint to peel. Also, leaving rubber or plastic products in contact with the cabinet for long periods of time may cause stains.
- **Cleaning the liquid crystal panel**
The liquid crystal panel tends to collect dust, so wipe it off occasionally with a soft cloth. The surface is easily scratched, so do not rub it with hard objects.

Handling Discs

Handling

- New discs may have some roughness around the edges. If such discs are used, the player may not work or the sound may skip. Use a ball-point pen or the like to remove any roughness from the edge of the disc.

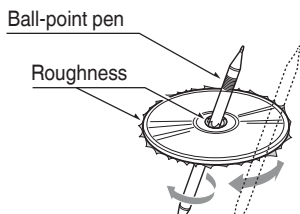

- Never stick labels on the surface of the disc or mark the surface with a pencil or pen.
- Never play a disc with any cellophane tape or other glue on it or with peeling off marks. If you try to play such a disc, you may not be able to get it back out of the DVD player or it may damage the DVD player.
- Do not use discs that have large scratches, are misshapen, cracked, etc. Use of such discs may cause misoperation or damage.
- To remove a disc from its storage case, press down on the center of the case and lift the disc out, holding it carefully by the edges.
- Do not use commercially available disc protection sheets or discs equipped with stabilizers, etc. These may damage the disc or cause breakdown of the internal mechanism.

Storage

- Do not expose discs to direct sunlight or any heat source.
- Do not expose discs to excess humidity or dust.
- Do not expose discs to direct heat from heaters.

Cleaning

- To remove fingermarks and dust, use a soft cloth and wipe in a straight line from the center of the disc to the circumference.
- Do not use any solvents, such as commercially available cleaners, anti-static spray, or thinner to clean discs.
- After using special disc cleaner, let the disc dry off well before playing it.

On Discs

- Never turn off the power and remove the unit from the car with a disc loaded.

CAUTION

For your safety, the driver should not insert or eject a disc while driving.

About the registered marks, etc.

- This product incorporates copyright protection technology that is protected by U.S. patents and other intellectual property rights. Use of this copyright protection technology must be authorized by Rovi Corporation, and is intended for home and other limited viewing uses only unless otherwise authorized by Rovi Corporation. Reverse engineering or disassembly is prohibited.
- Manufactured under license from Dolby Laboratories. "Dolby" and the double-D symbol are trademarks of Dolby Laboratories.
- "Made for iPod" and "Made for iPhone" mean that an electronic accessory has been designed to connect specifically to iPod or iPhone, respectively, and has been certified by the developer to meet Apple performance standards. Apple is not responsible for the operation of this device or its compliance with safety and regulatory standards. Please note that the use of this accessory with iPod or iPhone may affect wireless performance. iPhone and iPod are trademarks of Apple Inc., registered in the U.S. and other countries. Lightning is a trademark of Apple Inc.
- Android™ is the trademark of Google Inc.
- The Bluetooth® word mark and logos are registered trademarks owned by the Bluetooth® SIG, Inc. And any use of such marks by Clarion Co., Ltd. is under license. Other trademarks and trade names are those of their respective owners.

4. OPERATION PANEL

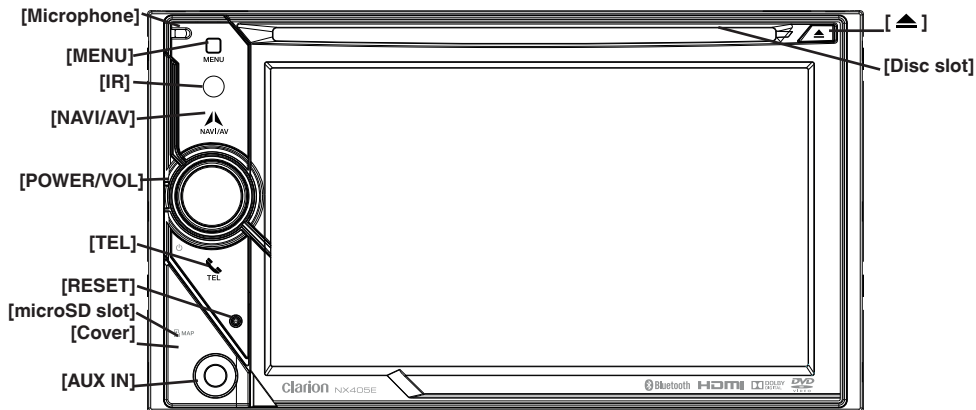

Only navigation map card is available and don't remove it when unit is power on

Functions of Buttons

[POWER/VOL] Knob

- Press this knob to turn on the power.
- When the power is already on, it moves to the Navigation mode. If Navigation mode is displayed, it moves to the Navigation menu.
- Keep pressing this knob more than 2 seconds to turn off the power.
- Turn this knob to left or right to decrease or increase the volume of the system.

[NAVI/AV] Button

- Press this button to display NAVI, press again to return current source.
- Press and hold this button for 2 seconds to display the Dimmer setting menu.

[▲] Button

- Press to eject disc from the unit.

[MENU] Button

- Press this button to display main menu; press again to return current source.
- Press and hold this button for 2 seconds to turn off the monitor. Press any place of the screen to turn on the monitor again.

[RESET] Button

- Press this button to hardware reset the unit.

Note:

When the [RESET] button is pressed, frequencies of radio stations, titles, etc. stored in memory are cleared.

[microSD slot]

Note:

The microSD card is only for navigation. Please don't insert microSD card for other purpose. After insertion of microSD card for MAP, don't remove it; otherwise, the navigation function will be disabled.

[AUX IN]

AUX 1 Connector.

[Microphone]

This is used for Bluetooth phone.

[IR] SENSOR

- Receiver for the remote control unit (operating range: 30 degree in all directions).

[TEL] Button

- Press this button to go to TEL mode.
- During incoming call press this button to pick up the call.
- During talking press this button to end the call.

5. REMOTE CONTROL

*Remote control unit is sold separately.

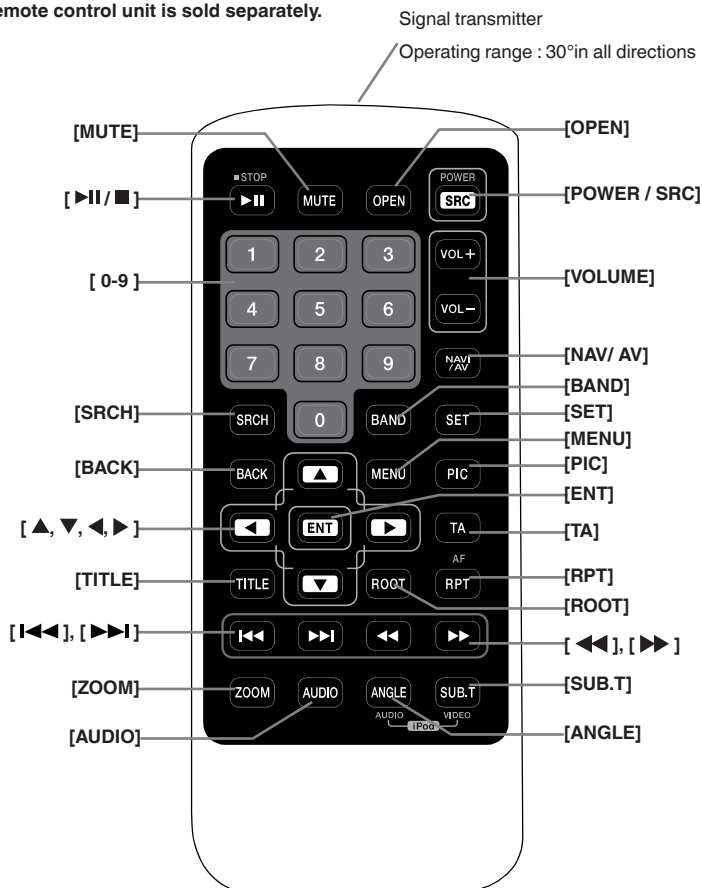

Replacing the batteries

1. Press the retention tab and pull out the battery tray and remove the old battery.
2. Insert the new CR2025 battery and slide the battery tray back in the remote control the same direction that you removed it. Please ensure the tray is inserted in the correct direction.

CAUTION

- Keep the battery out of the reach of children. Should the battery be swallowed, consult a doctor immediately.
- Batteries (battery pack or batteries installed) must not be exposed to excessive heat such as sunshine, fire or the like.

CAUTION

- Use one CR2025 (3V) lithium battery.
- Remove the battery if the remote control is not used for a month or longer.
- There is a danger of explosion if battery is incorrectly replaced. Replaced only with the same or equivalent type.
- Do not handle the battery with metallic tools.
- Do not store the battery with metallic objects.
- If the battery leaks, wipe the remote control completely clean and install a new battery.

- When disposing of used batteries, comply with governmental regulations or environmental public institutions' rules that apply in your country/area.

► Important

- Do not store the remote control in high temperatures or direct sunlight.
- The remote control may not function properly in direct sunlight.
- Do not let the remote control fall onto the floor, where it may become jammed under the brake or accelerator pedal.

Remote Control Functions

You can use the remote control to operate the NX405E.

Note:

- *The wireless remote control operation may not be optimal in direct sunlight.*

[▶II/■] Button

- Press this button to play or pause video and audio media.
- Press this button more than 1 second to stop video and audio media.

[MUTE] Button

- Mute or Unmute the speaker.
- The symbol  on upper right area of the screen indicates that speaker is muted.

[POWER/SRC] Button

- Press this button to move the focus to next available source item on main menu.
- Press this button to power on when the unit is power off.
- Press this button more than 1 second to power off when the unit is power on.

[0 - 9] Buttons

- Use in the Key Pad screen to select the radio.
- Use to select the track in the track list screen.
- Press to enter DVD video chapters/titles in the Key Pad screen.

[VOLUME] Buttons

- Increase and decrease volume.

[NAVI/AV] Button

- Press this button to switch between current source and current position on navigation map.

[SRCH] Button

- Press this button to open chapter or title search window while playing DVD.

[BAND] Button

- Switch to next band alternately.

[SET] Button

- Press this button to open the Audio setting menu in any mode.

[BACK] Button

- Press this button to quit main menu if current screen is main menu.

[▲], [▼], [◀], [▶] Buttons

- Press this button for cursor movement in main menu or Setting mode.
- From the main menu, you can select your desired source or change your settings.

[MENU] Button

- Press this button to enter the MAIN MENU or return current resource.

[PIC] Button

- Press and hold this button to change your monitor Dimmer.

[ENT] Button

- Press to fix the entered data in the Key Pad screen or enter the item the cursor is on.

[TA] Button

- Press this button to set TA On or Off.

[TITLE] Button

- Press to go to the title menu on the DVD.

[ROOT] Button

- Press to go to the root menu on the DVD.

[RPT] Button

- Press to perform chapter repeat / title repeat / repeat off while playing DVD mode.
- Press to perform Repeat Track/Repeat All while playing CD.
- Press to perform Repeat Track /Repeat Folder/Repeat All while playing MP3/WMA, or video files on disc.
- Press to perform Repeat Track /Repeat Folder/ Repeat All while playing MP3/WMA, or video files in USB memory.

[◀◀], [▶▶] Buttons

- Press to seek the next available lower or higher station in Tuner mode.
- Press to select the next lower or higher chapter number in DVD video mode.
- Press to select the next lower or higher track in CD, USB Video, USB Audio mode.
- Press for movement of background source in Navigation mode.

[◀◀], [▶▶] Buttons

- Press to manually select the next lower or higher station in Tuner modes.
- Press to perform fast-backward or fast-forward searching. Press again to change the speed to 2x, 4x, 8x or 16x.
- Press for movement of background source in Navigation mode.

[ZOOM] Button

- Press to turn on and zoom in while playing DVD. You can zoom in up to 3x. (No all DVD disc supports this function).

[AUDIO] Button

- Press to switch the AUDIO channel of the disc while playing DVD.

[SUB-T] Button

- Press to switch next available subtitle while playing DVD.
- Press to display Video menu in iPod mode.

[ANGLE] Button

- Press to switch the different ANGLE while playing DVD. (No all DVD disc supports this function)
- Press to display Audio menu in iPod mode.

[OPEN] Button

- Press to eject disc from the unit.

6. MAIN MENU

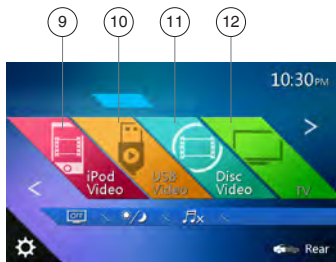

- 1 - Tuner---Touch the button to display the Tuner mode.
- 2 - HDMI---Touch the button to display the HDMI mode.
- 3 - Navi---Touch the button to display the Navigation mode.
- 4 - TEL--- Touch the button to display the Telephone mode.
- 5 - iPod Audio---Touch the button to display the iPod Audio mode.
- 6 - USB Audio---Touch the button to display the USB Audio mode.
- 7 - Disc Audio---Touch the button to display the Disc Audio mode.
- 8 - DAB---Touch the button to display the DAB mode.
- 9 - iPod Video---Touch the button to display the iPod Video mode.
- 10 - USB Video---Touch the button to display the USB Video mode.
- 11 - Disc Video---Touch the button to display the Disc Video mode.
- 12 - TV---Touch the button to display the TV mode.
- 13 - BT Audio--- Touch the button to display the Bluetooth Audio mode.
- 14 - AUX1 ---Touch the button to display the AUX1 mode.
- 15 - AUX2 ---Touch the button to display the AUX2 mode.
- 16 - Camera---Touch the button to display the Camera mode.
- 17 - Setting button---Touch the button to display the Setting menu.
- 18 - Monitor off --- Touch the button to turn off the monitor.
- 19 - Day/Night --- Touch the button to change the dimmer.
- 20 - Audio off---Touch the button to make audio source voice off.
- 21 - Rear---Touch the button to display the Rear mode.

Scrolling the menu

Flicking to right or left it will switch to next or previous page of main menu.

Moving the menu position

1. Touch any quadrate icon on main menu more than 2 seconds, the icon will float on main menu.
2. Scrolling the floating icon to any position you want.

7. DVD VIDEO PLAYER OPERATIONS

Discs

Playable discs

This DVD video player can play the following discs.

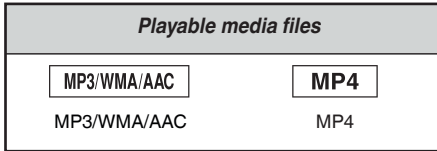

About CD Extra disc

A CD Extra disc is a disc in which a total of two sessions have been recorded. The first session is Audio session and the second session is Data session.

Your personally-created CDs with more than second data sessions recorded cannot be played on this DVD video player.

Note:

- When you play a CD Extra disc, only the first session will be recognized.

Discs that cannot be played back

This DVD video player cannot play back DVD-Audio, DVD-RAM, Photo CDs, etc.

Note:

- It may also not be possible to play back CDs recorded on a CD-R unit and CD-RW unit.
(Cause: disc characteristics, cracks, dust/dirt, dust/dirt on player's lens, etc.)
- If a CD-R or CD-RW disc that has not been finalized is played, it will take a long time to start playing. Also, it may not be possible to play depending on its recording conditions.
- You cannot play SuperAudio CD.
The CD player is not supported even if it is a hybrid disc.

About MP3/WMA/AAC playback

This unit can play back CD-R/CD-RW, DVD-R/RW and DVD+R/RW discs on which MP3/WMA/AAC music data have been recorded.

For a detailed information, see the section entitled "Listening to compressed audio".

Note on region numbers

The DVD video system assigns a region number to DVD video players and DVD discs by sales area. DVD video players sold in Europe can play back DVD discs with the region number "ALL", "2" or any combination of numbers that also incorporate a "2".

The DVD video region number is marked on the disc jacket as shown below.



Europe

Change DVD System Settings

Note:

If the setup operation is performed in the middle of DVD video play, the disc will restart from the beginning.

Selecting DVD Setup Menu

1. Touch the **[Settings]** button on the Main Menu to access the Video setup menu.
2. Touch **[Video]** button. The video menu is displayed.



Setting up the Screen Size

Touch the **[DVD Wide Screen Mode]** button to turn on or turn off the DVD wide screen mode.

The factory default setting is "off"

Note: Not all DVD disc support this function.

Setting up the password for parental level control

The factory default pass code is "0000".

1. In **Main Menu** Touch **[Settings]** button. Touch **[Others]** button on the display. Touch the **[Set Password]** ---- and a numerical key pad will appear.

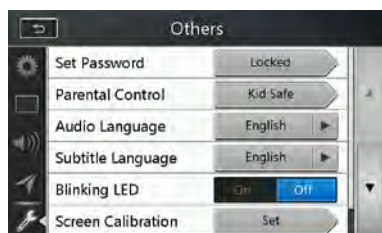

Input a new password and come again. The password is set.

Note:

When a disc with view restrictions is inserted, you will be prompted to input this password. The disc will not be viewable until the correct password is entered.

Set rating for parental level control

1. Select Others screen while in Setting mode. Touch **[Parental Control]** button. Touch the desired rating for level control. Use this table to set the parental level.

| | |
|----------|------------------------------|
| Kid Safe | Kid Safe |
| G | General Audiences |
| PG | Parental Guidance Suggested |
| PG-13 | Parents Strongly Cautioned |
| PG-R | Parental Guidance Restricted |
| R | Restricted |
| NC-17 | No One 17 And Under Admitted |
| Adult | Only Adult |

- The contents that the parental level restricts vary with the country code.

Note: The rating can be selected only under the password unlocked status, and the limits can be set only under the password locked status.

Watching to a Disc

1. To load a disc:
Insert the disc into the center of the insertion slot the label side facing up.



For your safety, the driver should not insert or eject a disc while driving.

Note:

- Never insert foreign objects into the disc insertion slot.
- If the disc is not inserted easily, there may be another disc in the mechanism or the unit may require service.
- 8cm (single play) discs cannot be used.

2. Disc starts playing automatically.

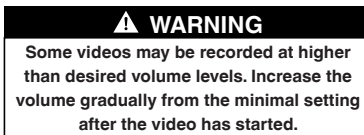

Ejecting a disc

1. To eject a disc press eject  button. The play mode then switches to the Tuner mode.
If the disc is left in the ejected position for 10 seconds, the disc is automatically reloaded. In this case, the play mode will remain in the Tuner mode.

Note:

If you force a disc into before auto reloading, it may damage a disc.

Showing DVD Player Mode Screen

After disc is loaded, the play mode is automatically engaged.

Touch any place of the screen to display DVD Video menu touch the screen again to return the playback screen. The display will return to the playback screen, if you do not touch the screen for 10 seconds.

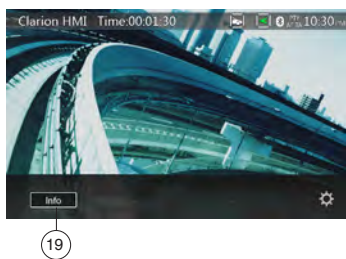

- 1 - Option button
- 2 - Show Cursor keys button
- 3 - Previous Chapter /Fast Backward button
- 4 - Play/Pause button
- 5 - Next Chapter /Fast Forward button
- 6 - Elapsed playing time
- 7 - Seek bar
- 8 - Total time
- 9 - Menu List button
- 10 - System time
- 11 - Bluetooth status indicator

- 12 - DVD playback information
- 13 - Shortcut button
- 14 - Repeat Switching button
- 15 - Audio Channel switching button
- 16 - Subtitle switching button
- 17 - Angle button
- 18 - Direct chapter or title searching button
- 19 - Information button

Operate the DVD Player Menu

You can select the button items displayed in the DVD menu by directly touching it.

Play/Pause Playback

1. Touch [] button to pause during playback.
2. Touch [] button again to resume playback.

Skip (Search) a Chapter

1. Touch [] or [] button during playback.
Chapters are skipped down or up from current locations, as many times as the button is touched, and playback starts.

Skip use seek bar

Touch the triangle [] on seek bar and drag it to any position where you want to start playback.

Fast Forward/Fast Backward

1. Touch [] or [] button and hold 2 seconds to start fast backward or fast forward during playback. The playback speed starts at 2x, then will increase to 4x, 8x, and 16x. Release the button will continue playing with normal speed.

Note:

- No audio is reproduced during fast forward and fast backward operation.
- The fast forward and fast backward speed may differ depending on the disc.

Search function

You can locate the beginning of a scene using the chapter numbers or title numbers recorded on the DVD Video disc.

1. Showing the DVD Video menu, touch [] button.
The Key Pad screen appears with the chapter/Title number input mode.

Touching [] button turns the Key Pad to the chapter number input mode.

Touching [] button turns the Key Pad to the title number input mode.

• Title

A large segment to divide the data area of the disc.

• Chapter

A small segment to divide the data area of the disc.

2. Input the number of the title/chapter that you want to play with the [0] to [9] key.
3. Touch the [] button.



Playback starts from the scene of the input title number or chapter number.

Note:

* If the input title/chapter number does not exist or searching with a title/chapter number is not allowed, the screen image will not change.

1. Touch **[Back]** button to close the key pad.

Repeat Playback

This operation plays back chapters recorded on the DVD-Video repeatedly.

1. Showing the DVD Video menu, touch **[Repeat]** button.
2. Touch **[Repeat]** button once for Repeat Chapter, again for Repeat Title.
3. Touch **[Repeat]** button again to turn off the repeat playback.

Using the Title Menu

On DVD discs containing two or more titles, you can select from the title menu for playback.



1. Showing the DVD Video menu, touch **[Menu]** button during playback.
 - * Depending on the disc, the title menu may not be called.
2. Touch the title menu screen. And touch the Show Cursor keys.
3. Select the items in the title menu screen by **[Left/Right]** directional buttons.
 - * Depending on the disc, items may not be selected with the directional buttons.
4. Touch **[OK]** button to fix on the selected item.
5. Touch **[Back]** button.

Switching Audio

On discs in which two or more audios or audio languages have been recorded, you can switch among the audio languages during playback.

1. Showing the DVD Video menu, touch **[Audio]** button during playback.
 - Each time you touch the button, you can switch among audio languages.
 - It may take time to switch among audios. Depending on the disc, up to 8 kinds of audios may be recorded. For details, see the mark of the disc: **(8)** Indicates that 8 audios have been recorded). When the power is turned on and when the disc is changed to a new one, the language set as the factory default is selected. If that language has not been recorded on disc the language is specified on the disc. Depending on the disc, switching may be completely impossible or impossible on some scenes.

Switching Subtitles

On DVD discs in with two or more subtitle languages have been recorded, you can switch among the subtitle languages during playback.

1. Showing the DVD Video menu, touch **[Subtitle]** button to select a subtitle during playback. Each time you touch the button, you can switch among subtitles.
 - It may take time to switch among subtitles. Depending on the disc, up to 32 kinds of subtitles may be recorded. For details, see the mark of the disc: **(.8)** Indicates that 8 kinds of subtitles have been recorded). Depending on the disc, switching may be completely impossible or impossible on some scenes.
2. To turn off subtitles, repeat touching **[Subtitle]** button until subtitles are turned off.

Displaying the playback status

Touch **[Info]** button on DVD Player mode screen, Playback status is displayed on screen.

Play video files

This system can play video files stored on disc.

Showing Video Files Player Mode Screen

1. After disc with video files is loaded, touch **[Disc Video]** button on MAIN MENU to show video files player mode screen.
2. Touch the screen of the playing video file to display Video files player menu touch the screen again to return the playback screen. The display will return to the playback screen, if you do not touch the screen for 10 seconds.



- 1 - Option button
- 2 - Previous Track /Fast Backward button
- 3 - Play/Pause button
- 4 - Next Track/Fast Forward button
- 5 - Elapsed playing time /Seek bar
- 6 - List Mode button
- 7 - System time
- 8 - Bluetooth status indicator
- 9 - Playback information
- 10 - Repeat button
- 11 - Audio button
- 12 - Subtitle button

Operate the Video Files Player Menu

You can select the button items displayed in the Video files player menu by directly touching it.

Play/Pause Playback

1. Touch [⏸] button to pause during playback.
2. Touch [▶] button again to resume playback.

Switch to Previous/Next File

1. Touch [⏮] or [⏭] button during playback to play previous /next file

Skip using seek bar

Touch the ball on seek bar and drag it to any position where you want to start playback.

Fast Forward /Fast Backward

1. Touch [⏮] or [⏭] button and hold 2 seconds to start fast backward or fast forward during playback. The playback speed starts at 2x, then will increase to 4x, 8x, and 16x. Release the button will continue playback with normal speed.

Note:

* No audio is reproduced during fast forward and fast backward operation.

* The fast forward and fast backward speed may differ depending on the disc.

Repeat Playback

This operation plays back video files recorded on the disc repeatedly.

The repeat set as the factory default is Repeat all.

1. Showing the video files player menu, touch [Repeat] button.
2. Touch [Repeat] button once for Repeat Track, again for Repeat Folder.
3. Touch [Repeat] button again for Repeat All.

Switching Audio

Some video files will have two or more audio channels; you can switch among the audio channels during playback.

1. Touch [Audio] button during playback.
 - Each time you touch the button, you can switch among audio languages.
 - It may take time to switch among audios.
- Depending on the disc, switching may be impossible.

Switching Subtitles

Some video files will have two or more subtitles have been recorded; you can switch among these subtitles during playback.

1. Touch the [Subtitle] button to select a subtitle during playback.
 - Each time you touch the button, you can switch among subtitles.
 - It may take time to switch among subtitles.
- Depending on the disc, switching may be impossible.

Video Files List

Showing the Video files player menu; touch the [≡] button to display video files list screen.

Video files list operations is almost same as Disc Audio player mode. Please refer to CD Player Operations.

Playable Video Disc Formats

This system can play video files stored on disc.

*.avi files

- format: MPEG4 Visual Simple @L1
- Picture size: 720 x 480
- Audio format: MP3
- Audio sampling frequency: 32/44.1/48 KHz

*.mp4 files:

- format: MPEG4 Visual Simple @L1
- Picture size: 720 x 405
- Audio format: AAC
- Audio sampling frequency: 32/44.1/48 KHz

*.mpg files

- format: MPEG2
- Picture size: 720 x 480
- Audio format: MP3
- Audio sampling frequency: 32/44.1/48 KHz

8. CD PLAYER OPERATIONS

Listening to a Disc/Ejecting a Disc

Please refer to Disc Video Player Operations -watching to a disc and Ejecting a disc.

Showing CD Player Mode Screen

1. After disc is loaded, the play mode is automatically engaged.
2. If disc have been loaded you can touch [Disc Audio] button on main menu to display CD player mode screen.

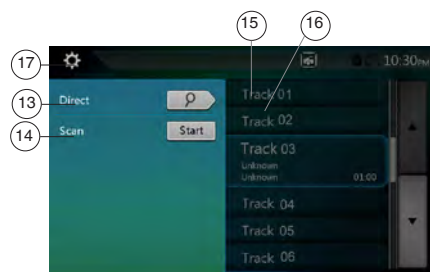
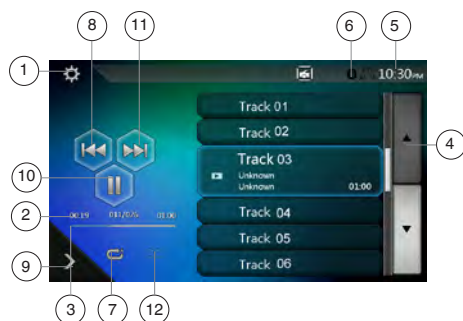

- 1 - Option button
- 2 - Elapsed playing time indicator
- 3 - Progress bar
- 4 - Page Turning button
- 5 - System time
- 6 - Bluetooth status indicator
- 7 - Repeat button
- 8 - Previous Track /Fast Backward button
- 9 - Shortcut button.
- 10 - Play/Pause button
- 11 - Next Track/Fast Forward button
- 12 - Shuffle button
- 13 - Direct Searching button

- 14 - Scan Start/Stop button
- 15 - Song Title
- 16 - Artist/album Information
- 17 - Close option menu Button

Operate the CD Player Menu

You can select the button items displayed in the CD player menu by directly touching it in list.

Play/Pause Playback

1. Touch [] button to pause during playback.
2. Touch [] button again to resume playback.

Switch to Previous/Next file or track

Touch [] or [] button during playback to play previous /next file.

- Touching [] button starts playback from the beginning of the next track.
- Touching [] button starts playback from the beginning of the current track. When this button is touched again within 5 seconds, playback starts from the beginning of previous track.

Fast Forward /Fast Backward

1. Touch [] or [] button and hold more than 2 seconds to start fast backward or fast forward during playback. The playback speed starts at 2x, then will increase to 4x, 8x, and 16x. Release the button will continue playback with normal speed.

Note:

* The fast forward and fast backward speed may differ depending on the disc.

Repeat Playback

- * The repeat set as the factory default is Repeat All.
- Touch [] button switch between Repeat Folder Repeat All and Repeat Track.

Shuffle Playback









1. Touch [] button to shuffle the tracks during playback.
2. Touch this button again to turn off the feature.

Selecting a track on the Track List Screen

This function allows you to select tracks from a displayed list.







1. Touch the track title on the display list. The selected track will start playing.
2. When the desired track is not displayed, touch and flick the track list up or down.
3. Touch the desired track title button. The corresponding track is started playback.

Scanning the Tracks

1. Touch [] button to show [Scan ] button.
 2. Touch [Scan ] button during playback.
 - It will play from next track, and each track will display for 10 seconds.
 - The [Scan ] button will switch to [Scan ] button.
 3. Touch [Scan ] button.
 - It will continue playback from current track.
 - [Scan ] button will switch to [Scan ] button.
- * The function will scan all tracks orderly in current folder once. After Scan stopped playback will continue.

Searching with the Track Number

This operation allows searching using the track numbers recorded on the CDs.

1. Touch [] button to show [] button.
 2. Touch [] button. The numerical keypad will appear on the screen and touch [] button.
 3. Input the track number that you want to play back with [0] to [9] key and touch [OK] button.
- Playback starts from the track of the input track number.
- If the input track number does not exist or searching with track number is not allowed, the screen image will not change.
 - Touch the [] button will close the numerical keypad.
 - Touch [] button will close the option window and display playback screen.

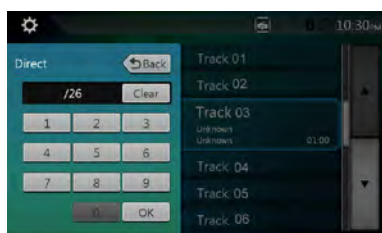

Listening to Compressed Audio

This system can play audio files stored on disc.
MP3/ WMA/ AAC

Tag Display Function

This unit is an ID3 Tag compatible model.
This unit supports the ID3 TAGs of the Version 2.4, 2.3, 1.1 and 1.0.
In displaying, this unit gives priority to the Version 2.3 and 2.4 TAGs.

Note:

- Some CDs recorded on CD-R/RW mode may not be usable.

Displaying MP3/WMA/AAC TAG titles

Tag information can be displayed for compressed audio file containing Tag information.

Tag data: title, artist, album

Precautions when creating MP3 disc

• File extensions

1. Always add a file extension “.MP3” or “.mp3” to an MP3 file, and “.WMA” or “.wma” to a WMA and “.m4a” to a AAC file by using single byte letters. If you add a file extension other than specified or forget to add these file extension, the file cannot be played. In addition, if you use upper case and lower case letters (capital and small letters) mixed for file extensions, normal play may not be possible.

2. Files other than MP3/WMA/AAC data cannot be played.

- Playing files with a format not supported will be skipped, and the scan, random and repeat playback mode may be canceled.

• File and Disc Not Supported

Files and discs with following extensions are not supported: *.AAC, *.DLF, *.M3U, *.PLS, *.MP3 PRO files, files with DRM, open session discs.

• Logical format (File system)

1. When writing an MP3/WMA/AAC file on a disc, please select “ISO9660 level 1 or level 2 (without including expansion format)” as the writing software format. Normal playback may not be possible if the disc is recorded on another format.

2. The folder name and file name can be displayed as the title during MP3/WMA/AAC play .

• Entering File and Folder Names

Names using the code list characters are the only file names and folder names that can be entered and displayed. Using any other character will cause the file and folder names to be displayed incorrectly.

• Folder structure

1. A disc with a folder having more than 8 hierarchical levels will conflict with the ISO9660 and playback will be impossible.

• Number of files or folders

1. The maximum allowable number of folders is 200 (including root directory); the maximum allowable number of files is 1500 (max. 200 per folder). This represents the maximum number of tracks that can be played back.
 2. Tracks are played in the order that they were recorded onto a disc. (Tracks might not always be played in the order displayed on the PC).
- Some noise may occur depending on the type of encoder software used while recording.

- In case of a track recorded at VBR (variable bit rate), the display for the play time of the track may be slightly different from the actual play time. Also, the recommended value of VBR ranges from 32kbps to 320kbps.
- After disc selection, the play mode is automatically engaged.

Playback MP3/WMA/AAC menu

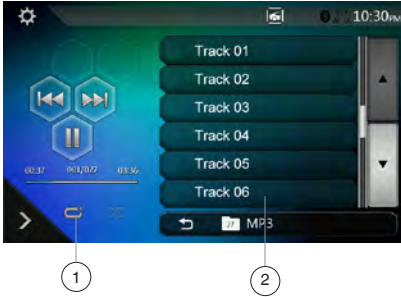

1. Repeat Playback

While playing MP3/WMA/AAC touch [🔁] button can switch between Repeat Folder, Repeat All and Repeat Track, Repeat Folder and Repeat All.

2. Current Folder

- Showing title of current folder.
- The number on the folder symbol is the number of files and folders number in current folder.
- Touch the title of current folder, playlist will show files and folders in upper folder.

** Other operations about playing MP3/WMA/AAC are almost same as CD Player mode.*

Stop Playback

1. Touch [⏏] button to stop playback.
 2. Touch [▶] button again to resume playback.
- Playback resumes from start of the folder which playing track is in.

- *Other operations about playing MP3/WMA/AAC are almost same as CD Player mode.*

9. USB AUDIO OPERATIONS

This system can play audio files (MP3/WMA/AAC/FLAC) stored in an USB memory which is recognized as "USB Mass Storage Class device". You can use your USB memory as an audio device by simply copying desired audio files into it.

Note:

- This system will not operate or may operate improperly with some USB memory.
- Files protected with any DRM cannot be played.

Notes on Using USB Memories

General notes

- When no support files, the file list display nothing.

Notes on the Audio files

- This system can play the MP3/WMA/AAC/FLAC files stored in the USB memory.

MP3 files:

- format: MPEG1/2 Audio layer3
- bit rate: 8k ~ 320Kbps
- sampling frequency: 8/12/16/24/32/44.1/48KHz
- file extension: .mp3

WMA files:

- format: Windows media Audio standard L3 profile
- bit rate: 32 ~ 192Kbps
- sampling frequency: 32/44.1/48KHz
- file extension: .wma

AAC files

- format: Advanced Audio Coding LC-AAC,HE-AAC
- bit rate: 32 ~ 320Kbps
- sampling frequency: 32/44.1/48KHz
- file extension: .m4a

FLAC files

- format: Free Lossless Audio Codec
- quantization bit rate: 16 or 24 bits
- sampling frequency: 44.1~192KHz
- file extension: .flac

Notes on the folder structure

- The folder hierarchy must be within 8 hierarchical levels. Otherwise, playback may be impossible.
- The maximum allowable number of folders is 65,535 (including root directory and folders with no MP3/WMA/AAC/FLAC file).
- The maximum allowable number of files in a folder is 65,535.
- You can store the MP3/WMA/AAC/FLAC files together in a folder.
- The system may become slow if the files or folders exceed the limitation above.

Notes on the Tag titles

MP3: title, artist, album

WMA: title, artist, album

AAC: can not display tag information.

Select USB Audio Mode

Connect your USB memory with MP3/WMA/AAC/FLAC files to the USB connector. The system will automatically detect the connected device, and the [USB Audio] button on main menu will be enabled.

- When an USB memory is already connected Touch [USB Audio] button to select the USB Audio mode. The system changes to the USB Audio mode and starts playback from the previous position or from the beginning.

Note:

This system has two USB connectors and can connect two USB.

You can select the desired USB by touching the list of USB root menu.

This system indicate the USB as "My USB1", "My USB2" on the list.

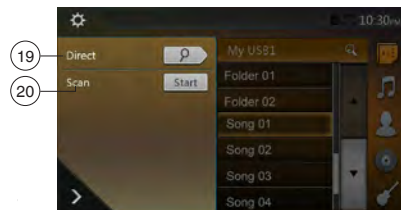
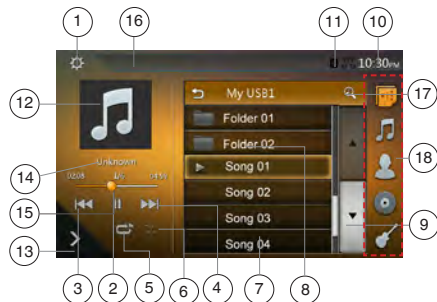

- 1 - Option button
- 2 - Play/Pause button
- 3 - Previous Track /Fast Backward button
- 4 - Next Track/Fast Forward button
- 5 - Repeat button

- 6 - Shuffle button
- 7 - Audio files in list
- 8 - Folders in list
- 9 - Page turning button
- 10 - System time
- 11 - Bluetooth status indicator
- 12 - Album Art (MP3,FLAC)
- 13 - Shortcut button
- 14 - Current ID3 info area
- 15 - Elapsed playing time indicator/Seek bar
- 16 - Playback status information
- 17 - Alphabet search button
- 18 - Category list
- 19 - Direct button
- 20 - Scan button

Playing Audio Files in USB Memory

Play/Pause Playback

1. Touch [⏮] button to pause during playback.
2. Touch [▶] button again to resume playback.

Switch to Previous/Next file

Touch [⏮] or [⏭] button during playback to play previous /next file.

- Touch [⏮] button to start playback from the beginning of the next track.
- Touch [⏮] button to start playback from the beginning of the current track; when this button is touched again within about 5 seconds, playback starts from the beginning of previous track.

Fast Forward /Fast Backward

Touch [⏮] or [⏭] button and hold more than 2 seconds to start fast backward or fast forward during playback. The playback speed starts at 2x, then will increase to 4x, 8x, and 16x .Release the button will continue playback with normal speed.

Note:

* The fast forward and fast backward speed may differ depending on the audio files.

Repeat Playback

* The repeat set as the factory default is Repeat All.

Touch the [🔁] button once for Repeat Track, again for Repeat Folder, Repeat All.

Shuffle Playback

1. Touch [🔀] button to shuffle the tracks in playing folder during playback.
2. Touch this button again to turn off the feature.

Alphabet Search

- Touch [🔍] button to search with alphabet in current list.

Album Art work

If MP3 audio file contains album art image in ID3, the picture will be displayed in this area.

ID3 Information Area

This area display ID3 information of playing file.

Skip Using Seek Bar

Touch [🔍] on seek bar and drag it to any position where you want to start playback.

Select a Folder on Display List

Touch the folder title on the display list, the display list will display files and folders in selected folder.

Selecting a Track on the Display List

This function allows you to select tracks from a displayed list.

1. Touch the track title on the display list. The selected track will start playing.
2. When the desired track is not displayed, touch and flick the track list up or down.
3. Touch the desired track title button. The corresponding track is started playback.

Scanning the Tracks

1. Touch [🔍] button to show [Scan Start] button.
2. Touch [Scan Start] button during playback.
 - It will play from next track, and each track will display for 10 seconds.
 - The [Scan Start] button will switch to [Scan Stop] button.
3. Touch [Scan Stop] button.
 - It will continue playback from current track.
 - [Scan Stop] button will switch to [Scan Start] button.
 - * The function will scan all tracks orderly in current folder once .After Scan stopped, playback will continue.

Searching with the Track Number

This operation allows searching to use the track numbers in playing folder.

1. Touch [🔍] button to show [🔍] button.
2. Touch [🔍] button .The numerical keypad will appear on the screen.
3. Input the track number that you want to play back with [0] to [9] key and touch [OK] button. Playback starts from the track of the input track number.
 - If the input track number does not exist or searching with a track number is not allowed, the screen image will not change.
 - Touch [⏪] button will close the numerical keypad.
 - Touch [⚙️] button will close the option window and display playback screen.

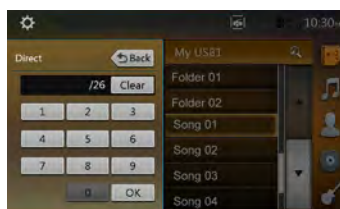

10. USB VIDEO OPERATIONS

This system can play USB video files (MP4, 3GP etc.) stored in an USB memory which is recognized as "USB Mass Storage Class device". You can use your USB memory as an video device by simply copying desired video files into it.

Note:

- This system will not operate or may operate improperly with some USB memory.
- Files protected with any DRM cannot be played.

Notes on Using USB Memories

General notes

When no support files, the file list display nothing.

Notes on the folder structure

The limitations on the folder structure are same as those in USB Audio Player mode.

Notes on the Tag titles

The limitations on the Tag titles are same as those in USB Audio Player mode.

Select USB Video Mode

Connect your USB memory with video files to the USB connector. The system will automatically detect the connected device, and the [USB Video] button on main menu will be enabled.

• When an USB memory is already connected

Touch [USB Video] button on main menu to select the USB Video mode.

The system changes to the USB Video mode and starts playback from the previous position or from the beginning.

Note: This system has two USB connectors and can connect two USB.

You can select the desired USB by touching the list of USB root menu.

This system indicate the USB as "My USB1", "My USB2" on the list.

Playing Video Files in USB Memory

If the video is playing, touch the screen of the playing video to display Operation buttons.

* The display will return to the playback screen, if you do not touch the screen for 10 seconds.

Playable Video Format

*.mp4 files

- format: MPEG4 Visual
MPEG4 AVC (H.264)
- Picture size: 720X480 (MPEG4 Visual)
- 1920 x 1080 (MPEG4 AVC)
- Audio format: AAC
- Audio sampling frequency: 32/44.1/48 KHz

*.m4v files

- format: MPEG4 Visual
MPEG4 AVC (H.264)
- Picture size: 720 x 480
- Audio format: AAC
- Audio sampling frequency: 32/44.1/48 KHz

*.mpg files

- format: MPEG2
- Picture size: 720 x 480
- Audio format: MP3
- Audio sampling frequency: 32/44.1/48 KHz

*.3gp files

- format: MPEG4 Visual
H.263
- Audio format: AAC, AMR
- Audio sampling frequency: 8/16/32/44.1/48 KHz

Note:

Even if the file format is mentioned above, NX405E cannot play all files.

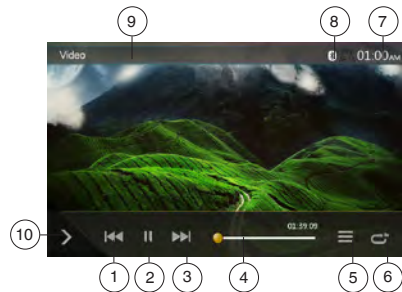

- 1 - Previous Track /Fast Backward button
- 2 - Play/Pause button
- 3 - Next Track/Fast Forward button
- 4 - Elapsed playing time indicator/Seek bar
- 5 - Menu List
- 6 - Repeat button
- 7 - System time
- 8 - Bluetooth status indicator
- 9 - Playback information
- 10 - Shortcut button

Play/Pause Playback

1. Touch [⏸] button to Pause playback.
2. Touch [▶] button to resume playback.

Switch to Previous/Next file

Touch [⏮] or [⏭] button during playback to play previous /next file.

- Touch [⏮] button to starts playback from the beginning of the next track.
- Touch [⏭] button to starts playback from the beginning of the current track; when this button is touched again within about 5 seconds, playback starts from the beginning of previous track.

Repeat Playback

* The repeat set as the factory default is Repeat All.

Touch the [🔄] button once for Repeat Track, again for Repeat Folder, again for Repeat All.

Skip Using Seek Bar

Touch the [🔍] on seek bar and drag it to any position where you want to start playback.

Switching USB Video Menu

Touch [☰] button playback will be paused, and the screen will switch to USB Video List.



- 1 - Option button
- 2 - Play/Pause button
- 3 - Previous Track /Fast Backward button
- 4 - Next Track/Fast Forward button
- 5 - Repeat button
- 6 - Shuffle button
- 7 - Video files in list
- 8 - System time

- 9 - Bluetooth status indicator
- 10 - Playback status information
- 11 - Shortcut button
- 12 - Current file information area
- 13 - Elapsed playing time indicator/Seek bar
- 14 - Alphabet search button
- 15 - Direct button
- 16 - Scan button

Play/Pause Playback

* On USB Video menu screen, playback status is pause. Touch [▶] button to resume playback. The screen will go to video screen automatically.

Switch to Previous/Next file

Touch [⏮] or [⏭] button during playback to play previous /next file.

- Touch [⏮] button to starts playback from the beginning of the next track.
- Touch [⏭] button to starts playback from the beginning of the current track; when this button is touched again within about 5 seconds, playback starts from the beginning of previous track.

Repeat Playback

* The repeat set as the factory default is Repeat All.

Touch the [🔄] button once for Repeat Track, again for Repeat Folder, again for Repeat All.

Shuffle Playback

1. Touch [🔀] button to shuffle the tracks in playing folder during playback.
2. Touch this button again to turn off the feature.

Alphabet Search

Touch [🔍] button to search with alphabet in current list.

Current File Information Area

This area displays information of current video file: file name, number of current file/total number in current folder, Elapsed playing time/total time of current file.

Skip Using Seek Bar

Touch [🔍] on seek bar and drag it to any position where you want to start playback.

Select a Folder on Display List

This operation is same as this in USB Audio mode.

Selecting a Track on the Display List

This operation is same as this in USB Audio mode.

Scanning the Tracks

This operation is same as this in USB Audio mode.

Searching with the Track Number

This operation is same as this in USB Audio mode.

11. iPod OPERATIONS

iPod/iPhone can be connected by using the connector cable supplied with the iPod/iPhone, but in this case, you can enjoy its audio sound only. To enjoy video movies stored in the iPod/iPhone with video displaying them on this unit, it is required to use the special connector cable (CCA-750) separately sold. However the new products such as the device with Lightning™ connector only can connect 10-pin cable (no video signal output), so these new products cannot display video in video mode.

Note:

- This system will not operate or may operate improperly with unsupported versions.
- For detailed information on the playable iPod/iPhone models, see our home page: www.clarion.com

Notes on Using iPod/iPhone

- Do not connect an iPod/iPhone to this unit with a headphone connected to the iPod/iPhone.
- After the iPod/iPhone has been connected to this unit, the buttons of iPod are disabled for operation in the Music mode. In the Video mode, do not operate the buttons of iPod.
- When in the iPod mode, the screen image input from the AUX terminal, is output to the rear monitor.
- When no data is present, the title display will remain blank.
- Set the language setting of iPod/iPhone to English before connecting your iPod/iPhone. Some characters of the other languages may not be displayed correctly in this system.

• Precautions on battery consumption:

If the iPod/iPhone is connected to this unit when the internal battery of iPod/iPhone has run down, this function may not operate correctly. You must connect the iPod/iPhone after charging the battery if it has run down.

iPod Audio Menu Operations

Connect your iPod/iPhone to the USB connector. The system will automatically detect the connected device.

Note:

1. This system has two USB connectors, please connect to the USB with the label of "iPod/iPhone". By connecting another USB cable, iPod/iPhone can't play back the music.
2. When the iPod mode and operate the audio player or internet radio other than iPod, there is a case that iPod doesn't playback correctly.





The playback starts after a while, from where the iPod/iPhone has been paused.

- When iPod/iPhone is already connected

Touch the [] button on the Main Menu screen. The system changes to the iPod mode, and starts playback from the previous position.

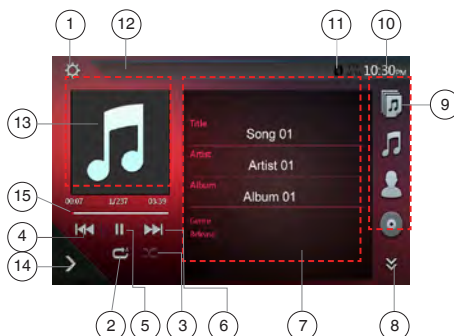
iPod Audio ID3 Mode Screen



- 1 - Option button
- 2 - Repeat button
- 3 - Shuffle button
- 4 - Previous Track /Fast Backward button
- 5 - Play/Pause button
- 6 - Next Track/Fast Forward button
- 7 - ID3 Information
- 8 - Next Page [] / Previous Page [] button
- 9 - Category list
- 10 - System time
- 11 - Bluetooth status indicator
- 12 - Playback status indicator
- 13 - Art work
- 14 - Shortcut button
- 15 - Progress bar

Play/Pause Playback

1. Touch [⏸] button to pause during playback.
2. Touch [▶] button again to resume playback.

Switch to Previous/Next file

- Touch [⏮] or [⏭] button during playback to play previous /next file.
- Touch [⏮] button to starts playback from the Touch of the next track.
- Touch [⏮] button to starts playback from the beginning of the current track; when this button is touched again within about 5 seconds, playback starts from the beginning of previous track.

Fast Forward /Fast Backward

Touch [⏩] or [⏪] button and hold more than 2 seconds to start fast backward or fast forward during playback.

Note:

* The fast forward and fast backward speed may differ depending on the audio files.

Repeat Playback

* depend on iPod.

1. Touch the [🔄] button once for Repeat Track, again for Repeat All.

Shuffle Playback

1. Touch [🔀] button to shuffle the tracks in playing folder during playback.
2. Touch this button again to turn off the feature.

Album Art work

If current audio file contains album art image in ID3, the picture will be displayed in this area.

ID3 Information Area

This area display ID3 information of playing file: song title, artist information, album information (Genre, playlist and release time).

Category List

Select different category songs to play. The category is same as the iPod/iPhone.

iPod Audio Playlist Mode Screen

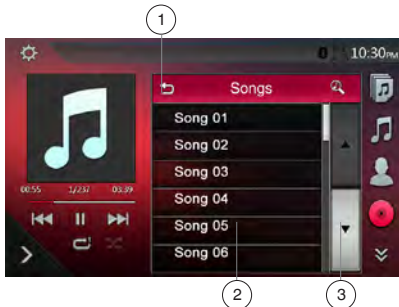

1 - Back to father folder

2 - Playing list

3 - Page turning button

- In the ID3 information mode screen, touch the ID3 info area to switch the playing list, and in the playing list mode screen, touch the button [⏮] to back to the father folder. If the list is in root, touch it to close the list.

iPod Audio List Mode Screen

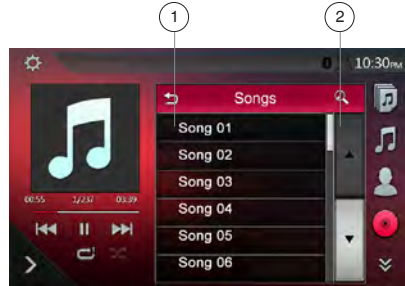

1 - Back to father folder

2 - Alphabet search button

- Touch the button [⏮] to back to the father folder. If the list is in root, touch it to close the list.
- Touch the button [🔍] to search with alphabet in current list

iPod Audio Simple Control Mode Screen

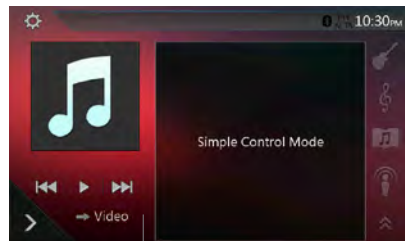
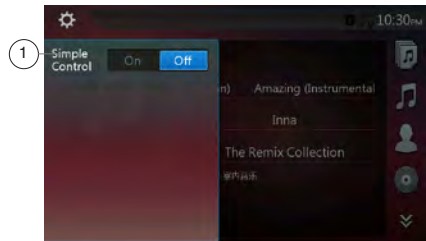

1 - Simple Control button.

2 - Video Mode button.

- If the Simple Control is set to [] in option menu, the screen will become Simple Control Mode. It can also display the video of iPod/iPhone regardless it is iPod Audio or iPod Video mode. But only "Previous Track", "Play/Pause" and "Next Track" can be operated.
- Touch [] the video will play from iPod.

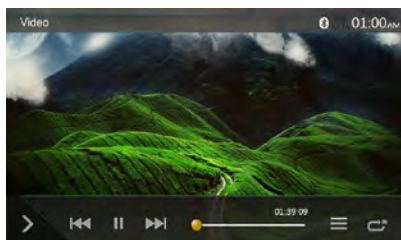

Skipping a Track (Simple Control Mode)

Touch the [] or [] button during playback. Tracks are skipped, as many times as the button is touched, and playback starts.

- Touch the [] button to starts playback from the beginning of the next track.
- Touch the [] button to starts playback from the beginning of the current track.

When this button is touched again within about 5 seconds, playback starts from the beginning of the previous track.

Note: In Simple Control Mode, the best way is to control the iPod just on iPod.

Selecting a list item from a list screen

- (1). Touch the list screen and flick up or down to scroll the list.
- (2). Touch a desired list item on the screen to display the corresponding list of tracks.
- (3). Touch the desired track name on the list to play it.

iPod Video Menu Operations

Connect your iPod/iPhone to the USB connector. The system will automatically detect the connected device.

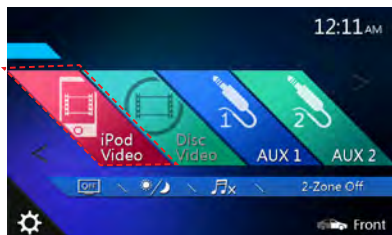

- **When an iPod/iPhone is already connected**
Touch the [] button on the Main Menu screen. The system changes to the iPod Video mode, and starts playback from the previous position.
Touch MENU button on Operational Panel to return to the Main Menu.

- **Viewing video data in the iPod/iPhone (only for the iPod/iPhone with video features)**

When you connect an iPod/iPhone with video features by using the optional connector cable for iPod/iPhone with video, you can enjoy the video data and slide show data stored in the iPod/iPhone and show them on the display of this unit (and the rear monitor if connected).

iPod Video ID3 Mode Screen iPod Video Menu Operations

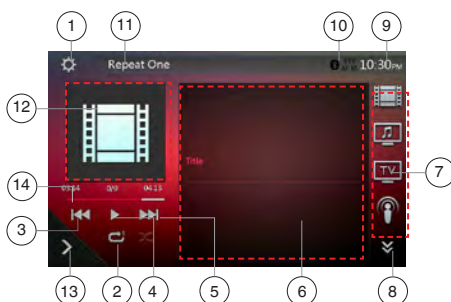

- 1 - Option button
- 2 - Repeat button
- 3 - Previous Track button
- 4 - Play/Pause button
- 5 - Next Track button
- 6 - Playing File title
- 7 - Category list
- 8 - Next Page [] / Previous Page [] button
- 9 - System time
- 10 - Bluetooth Status indicator
- 11 - Playback Status indicator
- 12 - Art work
- 13 - Shortcut button
- 14 - Progress bar

Play/Pause Playback

1. Touch [] button to pause during playback.
2. Touch [] button again to resume playback.

Switch to Previous/Next file

- Touch [] or [] button during playback to play previous /next file.
- Touch [] button to starts playback from the beginning of the next track.
- Touch [] button to starts playback from the beginning of the current track.

Repeat Playback

* The repeat set as the factory default is depend on iPod/iPhone.

1. Touch the [] button once for Repeat One, again for Repeat All.

Album Art work

If current video file contains album art image in ID3, the picture will be displayed in this area.

ID3 Information Area

The area is display the title of the playing file.

Category List

Select different category movies to play. The category is same as the iPod/iPhone.

iPod Video List Mode Screen



This operation is same as this in iPod Audio mode.

iPod Video Simple Control Mode Screen

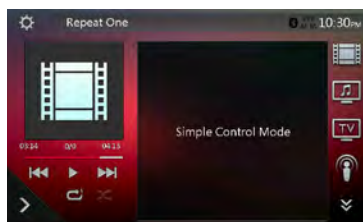
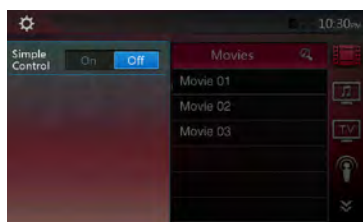



This operation is same as this in iPod Audio mode.

iPod Video Play Mode Screen







- 1 - Previous Track /Fast Backward button
- 2 - Play/Pause button
- 3 - Next Track/Fast Forward button
- 4 - Progress bar
- 5 - Menu List button
- 6 - Repeat button
- 7 - System time
- 8 - Bluetooth status indicator
- 9 - Playback information



Play/Pause Playback

1. Touch [] button to pause during playback.
2. Touch [] button again to resume playback.

Switch to Previous/Next Track

- Touch [] or [] button during playback to play previous /next track.
- Touch [] button to starts playback from the beginning of the next track.
- Touch [] button to starts playback from the beginning of the current track; when this button is touched again within about 5 seconds, playback starts from the beginning of previous track.beginning of the current track.

Fast Forward /Fast Backward

Touch [] or [] button and hold more than 2 seconds to start fast backward or fast forward during playback. Release the button will continue playback with normal speed.

Note:

* The fast forward and fast backward speed may differ depending on the video files.

Repeat Playback

* The repeat set as the factory default is Repeat Off.

Touch the [] button once for Repeat One, again for Repeat All.

Note:

The operation in iPod video mode is as same as iPod Audio mode. Please refer to the iPod Audio Mode operation.

Note:

Video playback is not available on all iPod/ iPhone devices. Please contact your Clarion dealer for details. An optional connection cable or accessory may be required for this feature.

Note:

- Video is not displayed when the automobile is moving.
- Image data may not be played back according to the status of the iPod/iPhone.
- The volume setting of video data is relatively lower than audio data. Be sure to lower the volume setting before switching to the other mode.
- Do not select the categories with no track registered from the iPod menu screen. The iPod/iPhone may be frozen. If the iPod/iPhone is frozen, reset the iPod/iPhone by following the procedure described in the instruction manual of the iPod/iPhone.
- Audio may be played back slightly out of synchronization with video images.

12. Bluetooth® AUDIO PLAYER OPERATIONS

Some Bluetooth cellular phones have audio features, and some portable audio players support the Bluetooth feature. These devices will be called as "Bluetooth audio players" in this manual. This system can play audio data stored in a Bluetooth audio player.

Note:

- This system will not operate or may operate improperly with some Bluetooth audio players.
- For detailed information on the playable Bluetooth audio players, see our home page: www.clarion.com

Selecting the Bluetooth Audio Mode

1. Touch the **[BT Audio]** button to select the Bluetooth Audio mode.

The system changes to the Bluetooth mode. If the connection with a Bluetooth audio player has been already established, you may select the Music function.

2. Press MENU button on Operational Panel to return to the Main Menu.
- When the connection with blue icon a Bluetooth audio player has been established, the **[BT]** icon is displayed at the top of the screen.

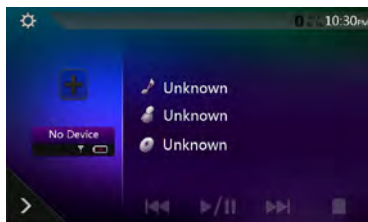

Registering Your Bluetooth Audio Player (Pairing)

You can register up to 3 Bluetooth audio players. Your mobile phone Bluetooth version is under 2.0. Please input PIN code "0000".

1. Turn on the power of the Bluetooth audio player you wish to register.
2. Touch the Device Select button to display the Device Select screen.

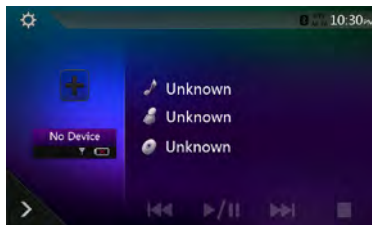

3. Touch the **[+]** button to display the Inquiring Device screen.

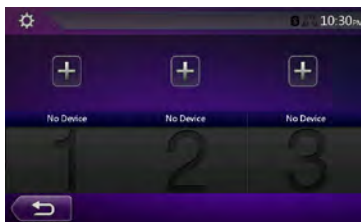

Bluetooth Audio Player Settings

You can confirm various information concerning about the Bluetooth Interface features.

1. Touch the **[Settings]** button to display the information on the screen.
2. When you finish confirming the Bluetooth information, touch the **[Settings]** button to return to the previous screen.

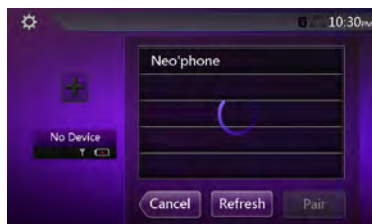
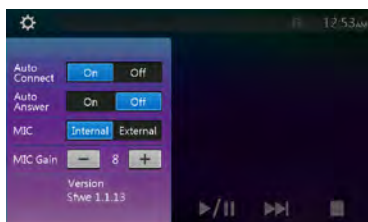

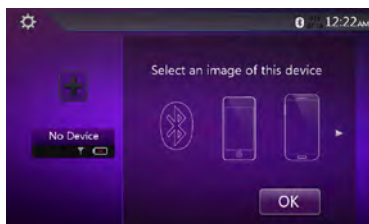

4. Touch your desired device button and touch **[Pair]** button to register for the Bluetooth audio player. Then select an image of this device.

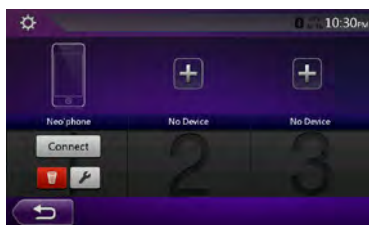

When the pairing operation completes, the registered Bluetooth audio player is set as the current device, after selecting the favorite icon, the display return to the device list screen. Touch  button, the display will return to the Bluetooth audio mode screen.





• To delete the Bluetooth audio player registration

1. Touch the  button to delete the device. A confirmation screen is displayed.
2. Touch the  button to confirm delete.

Selecting the Bluetooth Audio Player

To change the current Bluetooth audio player to the other device which is already registered, perform the following operation.

1. Touch the device button to display the Device Select screen.
2. Touch the currently connected device button, then touch the  button to disconnect the active device.
3. Touch the desired Device button you wish to use. Touch  button to select it as your active device. The corresponding cellular phone is set as current telephone.
4. Touch the  button to return to the previous screen.

Controlling the Bluetooth Audio Player

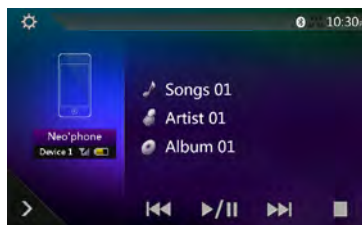

Note:

- Occasionally, depending on the environment, playback sounds may be fragmented, or switch noises may be generated.

Playing Music

After the connection with a Bluetooth audio player is established, the play mode is automatically engaged.

- When playback is not started for some devices, touch the  button manually.

Pausing Playback

1. Touch the  button during playback.



Playback Pauses

2. To resume playback, touch the  button. Playback resumes.

Skipping a Track Searching

3. Touch the  or  button during playback.

Stopping Playback

4. Touch the  button during playback. Tracks are stopped, touch the  button to playback the first Track.

13. Bluetooth® TELEPHONE OPERATIONS

When the connection with your Bluetooth cellular phone is established, the following functions are available on this unit:

- Listening to your telephone calls on the car speakers.
- Answering to an incoming call.
- Making a call using the Ten-Key pad screen.
- Making a call using the Phone Book data in the selected cellular phone.
- Making a call using the History data of the dialed/received calls.

Note:

- Some cellular phones may not be able to transfer the Phone Book data to head unit.
- The Phone Book data transmission may take a long time. The operations of sending calls are disabled during the data transmission.

Select the BT Phone Mode

1. Touch the [TEL] button to select the Bluetooth Telephone mode.
- The Telephone screen is displayed.
2. Press MENU button on Operational Panel to return to the Main Menu.
- When no Bluetooth Telephone connected, the icon [No Device] is displayed at the top of the screen.

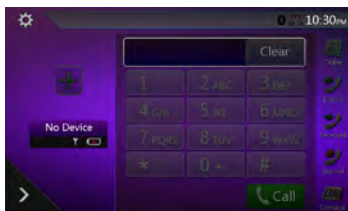

- When the connection with a Bluetooth Telephone has been established, the icon [Neo phone] is displayed at the top of the screen.

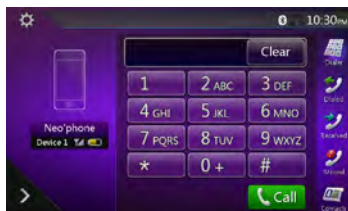

Bluetooth Telephone Settings

You can confirm various information concerning about the Bluetooth Interface features.

1. Touch the [Settings] button to display the information on the screen.
2. Perform setting for the desired item. See the following sections for detail.
3. When you finish confirming the Bluetooth information, touch the [Settings] button to return to the previous screen.

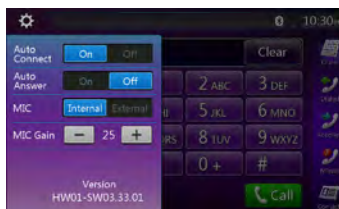

Setting Automatic Connection

The system automatically reconnects the cellular phone after the connection is lost or the system is restarted.

- The factory default setting is "ON". Touch the [On] or [Off] button of the Automatic Connection item to set the function ON or OFF.

Setting Automatic Answer

If a call comes in, answer automatically after 5 seconds.

- The factory default setting is "OFF". Touch the [On] or [Off] button of the Automatic Answer item to set the function ON or OFF.

Setting Microphone Gain

You can adjust the input level of the microphone in 30 levels.

- Touch the level indicator button of the Microphone Gain item to adjust the input level.

Note:

- The input level of the microphone can be affected by its surroundings. Adjust the level if the person on the other end of the telephone has a reception problem.

Registering Your Cellular Phone (Pairing)

You can register up to 3 cellular phones. The registering method is the same as "Registering your Bluetooth audio player".

Your mobile phone Bluetooth version is under 2.0.

Please input PIN code "0000".

1. Turn on the power of the cellular phone you wish to register.
2. Touch the Device button  to display the Device Select screen.

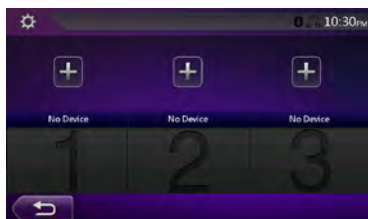
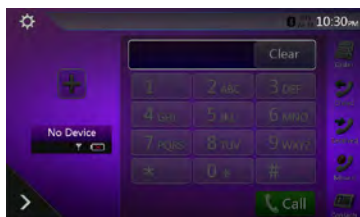

3. Touch the  button to display the Inquiring Device screen.

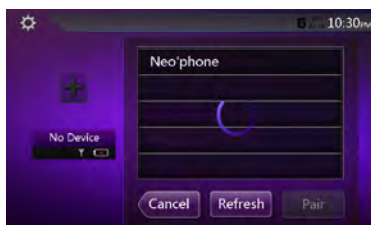



4. Touch your desired Cellular button to select the button for the cellular phone to be registered, and touch  button to register for the Bluetooth cellular phone.

You cannot select the Cellular button of which another cellular phone is already registered. Select a blank Cellular button.

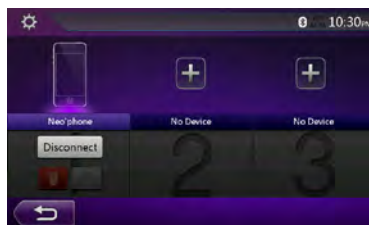
5. If entering the Pass Key code is prompted on your cellular phone, enter the Pass Key code set in this unit.





When the pairing operation completes, the registered cellular phone is set as the current telephone, and the display returns to the Telephone screen.

- To delete the cellular phone registration
 1. Touch the  button to delete the device. A confirmation screen is displayed.
 2. Touch the  button to confirm delete.

Select the Cellular Phone

To change the current cellular phone to the other device which is already registered, perform the following operation.

1. Touch the device button to display the Device Select screen.
2. Touch the currently connected device, then touch  button to disconnect the active device.
3. Touch the desired Device button you wish to use. Touch  button to select it as your active device. The corresponding cellular phone is set as the current telephone.
- If the power of the cellular phone is not turned on, turn it on.
- The cellular phone may prompt to acknowledge the Bluetooth connection or to enter the Pass Key code of this unit. Perform these operations according to the message displayed.
4. Touch the  button to return to the previous screen.

Get the Phone Book Data

Sending the Phone Book data from the cellular phone enables you to make a call using the Phone Book function from this unit.

Telephone Operations



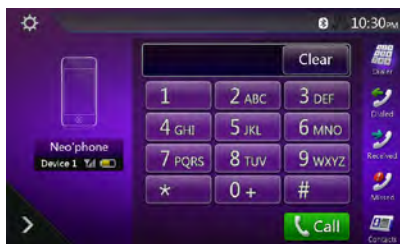

Making a call using the Ten-Key pad

1. Touch the  button to display the Ten-Key pad screen.
2. Enter the telephone number by using the Ten-Key pad displayed on the screen.

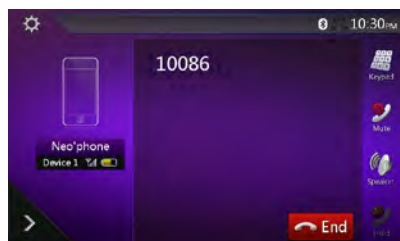

3. Touch the  (Send) button to call the entered number.
- The following Telephone Interrupt screen is displayed during phone call.



- Touch the  button to talk by using the cellular phone and canceling the hands-free function (Private Mode). To return to the hands-free mode, touch the  button again.
- Touch the  button to mute the microphone. Now you can hear the other side, but the other side cannot hear your side.
- Touch the  button to hold the current phone call, now you can answer to the other incoming call. Touch again to talk with previous call If during a call with a third-party call, you can keep the current call to answer a third party or hang up the current call to answer a third party. You can also ignore the third-party calls.

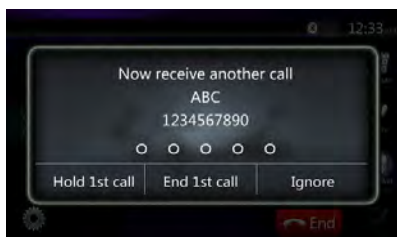

4. When the call is finished, touch  button to hang up.

Note:



- Depending on some special cellular phone, the Telephone Interrupt screen may be closed and the connection with this system may be disconnected when entering the Private mode.

Making a Call Using the Phone Book

You can use the Phone Book data obtained from the cellular phone to make a call from this unit.



Note:

- Before using this function, the Phone Book data must be sent from the cellular phone.
- Only the Phone Book items with at least one telephone number registered in the captured Phone Book data are displayed on the Phone Book screen.

1. Touch the  button to display the Phone Book screen.
 2. Touch the desired name button you wish to dial.
- Flick the list up and down to scroll the list.
3. Touch the  button to call the specified number. The Telephone Interrupt screen is displayed, and calling starts.
- When the call is finished, touch the  button to hang up.

Making a Call Using the History

The system will memorize the Dialed/Received calls record data in the memory. You can confirm it and use it to make a call from this unit.



1. Touch the  button. The History List screen is displayed.
- The items are sorted by Dialed, Missed and Received calls.
 - Flick the list up and down to scroll the list.
2. Touch the desired History item key you wish to dial.
 3. Touch the  button to call the specified number. The Telephone Interrupt screen is displayed, and calling starts.
- When the call is finished, touch the  button to hang up.

Answering to an incoming call

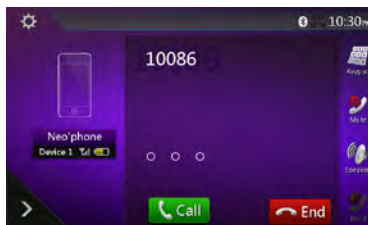
When a call comes in, the following Telephone Interrupt screen appears.



You can answer to the incoming call on this system by the following operation.

1. Touch the  button to answer the call.
2. When the call is finished, touch the  button to hang up.

14. TUNER OPERATIONS

The tuner in this head unit contains RDS (Radio Data System) in FM band.

Listening to the Tuner

1. Touch the **[Tuner]** button on the main menu display. The tuner mode screen is displayed.
2. Touch the **[FM1/FM2/FM3/AM]** button to select the radio band. Each time the button is touched, the radio reception band changes in the following order: FM1->FM2->FM3->AM-> FM1...

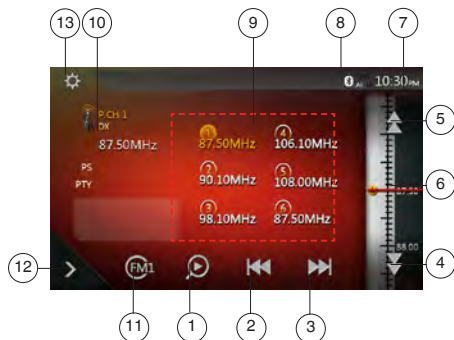

- 1 - Preset Scan button
- 2 - Seek down button
- 3 - Seek up button
- 4 - Step down button
- 5 - Step up button
- 6 - Frequencies display
- 7 - System time
- 8 - Bluetooth status indicator
- 9 - Preset channel list
- 10 - DX/Local indicator
- 11 - Band button
- 12 - Shortcut button
- 13 - Option button

Seek Tuning

1. Touch the **[FM1/2/3/AM]** button to select the radio band (FM or AM).
2. Touch the **[<<]** or **[>>]** button
 - When touch the **[>>]** button, the station is searched in the direction of higher frequency.
 - When touch the **[<<]** button, the station is searched in the direction of lower frequency.

Step Tuning

1. Touch the **[FM1/2/3/AM]** button to select the radio band (FM or AM).

2. Touch the **[<<]** or **[>>]** button in frequency menu to tune up or down by one step.

Recalling a preset station

1. Touch the **[FM1/2/3/AM]** button to select the desired band (FM or AM) on the tuner.
2. Press the preset station (1 to 6) on Preset list.

Manual memory

1. Touch the desired band button to select the band you wish to store.
2. Tune to a station you want to store using the seek tuning, step tuning, or preset tuning.
3. Touch and hold the desired Preset button you want to store for about 2 seconds.

RDS Function Setting

Press the **Option** to set the RDS operation.

Note:

The RDS operation does not work during AM radio reception.

1. TA (Traffic Announcement) Function

When a traffic announcement broadcast starts during the TA standby mode, the traffic announcement broadcast is received as higher priority regardless of the current function mode, so you can listen to it. The Traffic Program (TP) automatic tuning is also available.

Setting TA Standby Mode

Turn TA switch to ON, TA standby mode is set and "TA" will be displayed at the top of the screen.

When an RDS broadcast station with traffic announcement program is received, "TP" will be displayed at the top of the screen.

Note: If no TP station is received this system continues the search operation. Performing the above procedure again makes the "TA" turns to off, and stops TP station searching.

Canceling a Traffic Announcement Broadcast

Press the **[Cancel]** button while a Traffic Announcement broadcast is being received. The Traffic Announcement broadcast reception is canceled, and the system goes into the TA standby mode.

Canceling TA Standby Mode

When "TA" is displayed on the screen, turn TA switch to OFF, "TA" on the screen goes off, and the TA standby mode is canceled.

Volume Setting of TA

The volume of TA can be set during TA interruption.

2. AF (Alternative Frequency) Function

The AF function switches to a different frequency on the same network in order to maintain optimum reception.

Auto Store

The Auto Store is a function for storing up to 6 stations that are automatically searched in sequentially. If the number of receivable stations cannot reach to 6, the previous stored station remains.

1. Touch the **[FM1/2/3/AM]** button to select the desired band. (FM or AM)
2. Touch the **[🔍]** button, and then touch the **[Start]** button to start the Auto Store.

A beep sounds and the stations with good reception are stored automatically to the preset list.

Notes:

1. After auto store, the previous stored stations will be overwritten.
2. The unit has 4 bands, but FM3 and AM can store by Auto Store function.



Preset Scan

The Preset Scan receives the stations stored in the preset memory in order. This function is useful when searching for the desired station in memory.

1. Touch the **[FM1/2/3/AM]** button to select the desired band. (FM or AM)
2. Touch the **[🔍]** button to start the Preset Scan.

The unit starts scanning each station for 10 seconds sequentially. But the station stored is not a valid station; the scanning time is only 2 seconds.

3. When the desired station is tuned in, touch the **[🔍]** button again to stay in that station.

DX/Local Setting

The DX / Local setting changes the tuner sensitivity in order to separate closely spaced stations. This feature is useful in areas that have many radio stations in close proximity.

15. DAB OPERATIONS

Setting to DAB

Before using DAB system, please set the adjust in Settings.

Please select "DAB" in DAB/TV (Option) of Settings to activate DAB icon on Main menu.

Listening to the DAB

1. Touch the DAB button on the main menu display. The DAB mode screen is displayed.
2. Touch the [DAB1/DAB2/DAB3] button to select the DAB band. Each time the button is touched, the DAB reception band changes in the following order: DAB1->DAB2->DAB3->DAB1 -> DAB2...

Note:

1. DAB is not broadcast everywhere.
2. This content is optional. If you connect DAB unit, you can use DAB feature.
3. DAB unit is sold separately.

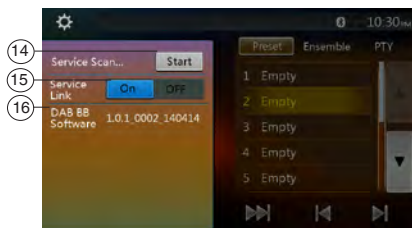
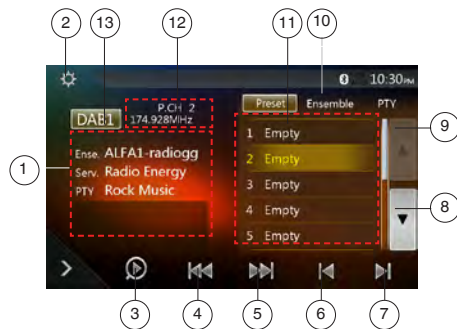

- 1 - DAB Information display
- 2 - Option button(open/close)
- 3 - Preset Scan button
- 4 - Previous Ensemble/Seek button
- 5 - Next Ensemble/Seek button
- 6 - Previous Service in Current Ensemble button
- 7 - Next Service in Current Ensemble button
- 8 - List Page Down button
- 9 - List Page Up button
- 10 - Preset List/Service List Switch button

- 11 - Service List display in each category (Preset/ Ensemble / PTY)
- 12 - Preset number/Channel number/Service number/ FM Link display
- 13 - DAB band button
- 14 - Service List Update button
- 15 - Service Link Mode button
- 16 - Software version display

Seek Tuning

You can tune to the Ensemble and select the Service which is currently broadcast.

1. Touch the [◀] or [▶] button to tune to previous or next ensemble station manually step by step.
2. Long touch the [◀] or [▶] button to seek and tune to previous or next available ensemble station.
3. Touch [◀] or [▶] button to select and tune to previous or next Service in current Ensemble.

Notes:

Total number and the current service number of the current Ensemble is displayed just below the Ensemble frequency display, as in the way "1/16".

Preset List/Service List Display

You can select the list from Preset List, Ensemble List or PTY List.

1. Touch the [Preset Ensemble PTY] button to select the list you want to display.
2. When you select "Preset", the list area displays preset services for each DAB Band. If you touch service in the list, you can listen to respective service in this list. If you touch and hold in the list, you can store current service in this list. Preset List will not be changed by Service Scan operation.
3. When you select "Ensemble", the list area displays Ensemble list which were stored by Service Scan. By selecting each Ensemble in the list, it will show the Services in this Ensemble. If you select "ALL Service", you can see all Services in all Ensembles. To go back to Ensemble list just touch "back" button.
4. When you select "PTY", the list area displays PTY category list from NEWS, SPORT, CULTURE, POP and OTHERS. By selecting each PTY in the list, it will show the Services in this PTY category. To go back to Ensemble list just touch "back" button.

Note:

If you want to update the services in Ensemble list and PTY list with current broadcasting, please perform Service Scan.

Service Scan

When you want to update the list with the current services in Ensemble List or PTY List, please perform Service Scan.

1. Touch the option button  to open option menu display.
2. In Option Menu, touch the **[Start]** button.
3. Touch the **[OK]** button to start updating the service list, touch the **[Cancel]** button to cancel this operation then back to previous menu.

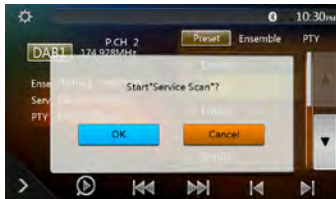

4. When scanning the services, this image will display.

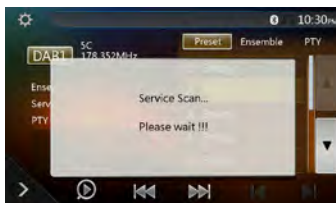

Notes:



After service scan, currently available services will be updated in the Ensemble List and PTY List.

DAB Band

When touch the DAB band button, the band will change as below DAB1->DAB2->DAB3->DAB1...



Preset Scan

Preset Scan tunes to the Services stored in the preset list in order.

1. Touch the **[DAB1/2/3]** button to select the desired band.
2. Touch the  button to start the Preset Scan. The unit starts scanning each service for playing 10 seconds sequentially.
3. When the desired service is tuned in, touch the  button again to stay in that service.

Service Link Setting

You can select Service Link mode from On or OFF. If this setting is set to On, and current Service signal gets weak, it is to be linked to the service with better signal.

1. Touch the option button  to open option menu display.
2. Touch the  button to switch On or OFF.

Note:

If the service is linked to the FM station, the FM indicator will be turned on.

16. TV OPERATIONS

When TV device connect to unit, you can watch TV program and operate DVB-T device.

Different DVB-T device have different operate mode, please read the user manual of the DVB-T device connected to unit.

This function is available when a DVB-T Black Box is connected.

This unit can control the following DVB-T Black Box: (DTX502E)

* DTX502E is sold separately.

Note:

For your safety, the unit has a safety function, which turns off the picture when car is moving, so only the audio can be heard. The picture can be only watched, when the car is stopped and parking brake is applied.

Switching to DVB-T mode

- Touch **[TV]** key on Main Menu to select desired mode (when unit is reading). The LCD will display the external video. If there is no DVB-T signal, it will show you blank screen.
- Press **[Menu]** button on Operational Panel to return to the Main Menu.

17. HDMI MODE

Wire Connection of HDMI Mode Wire Connection of HDMI Mode

iPhone 4, iPhone 4s, iPhone 5, iPhone 5s, iPhone 5c, iPhone 6 and iPhone 6 Plus can be connected by using the connector cable supplied with the iPhone 4, iPhone 4s, iPhone 5, iPhone 5s, iPhone 5c, iPhone 6 and iPhone 6 Plus and HDMI cable (sold in the market) or CCA-802 (sold separately) and digital Av adapter

Note:

The following is part of the wiring example.

Depending on the device, there is a case to connect to the device directly with the CCA-771.

Depending on the adapter or device, there is a case that the audio noise and video noise is generated.

- (1) Connection with the iPhone 4 and iPhone 4s

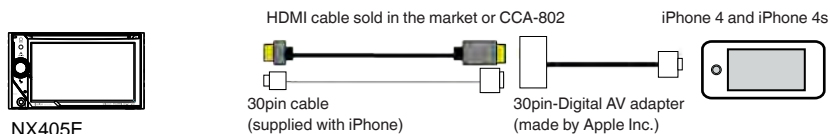

- (2) Connection with the iPhone 5, iPhone 5s, iPhone 5c, iPhone 6 and iPhone 6 Plus

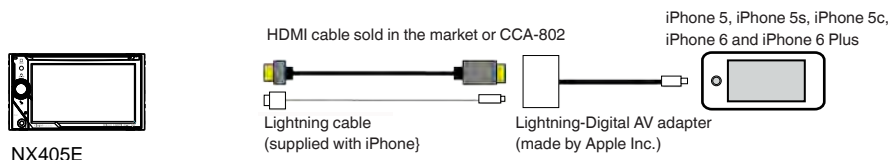

- (3) Connection with the Android Phone

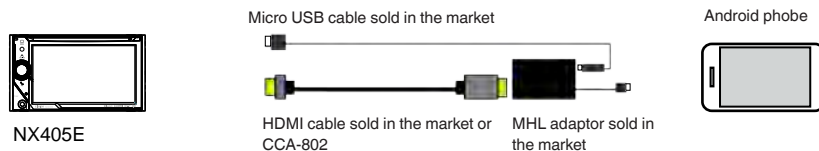

- (4) Connection with the equipment with HDMI output

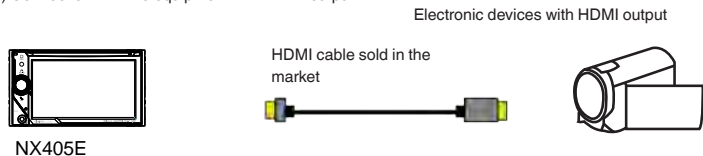

Select HDMI Source



Touch the HDMI menu button, then appear the screen of the connected device.

This HDMI mode is only indicate the screen of the iPhone, Android. Can't operate by the touch screen of NX405E.

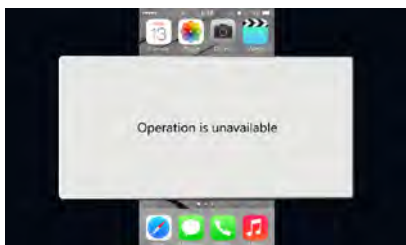

Note:

Depending on the application and model of the mobile phone, there is the case that black frame appears around the screen.

18. AUX

External peripheral devices, including a game console, camcorder, navigation unit, iPod/iPhone, etc. can be connected to the AUX connector on the front or back of this unit using the A/V media cables.

Switching to AUX IN

Touch **[AUX1]/[AUX2]** button on Main Menu to select desired mode (when unit is reading). If the external device connected to AUX input have audio signal, the unit will broadcast audio of external device. Press Menu button on Operational Panel to return to the Main Menu.

You cannot directly control external devices connected to AUX input.

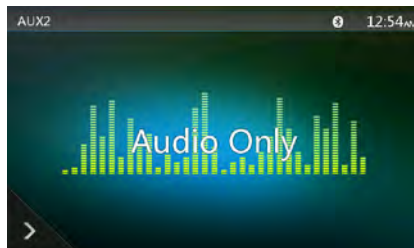
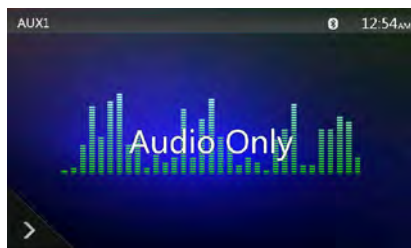

19. CAMERA INPUT OPERATIONS

Switching to Camera mode

Touch **[Camera]** button on Main Menu.

The LCD will display the external camera video. The screen will display "No Video Signal" message, if a valid camera is not connect to this head unit.

Press MENU button on Operational Panel to return to the Main Menu.

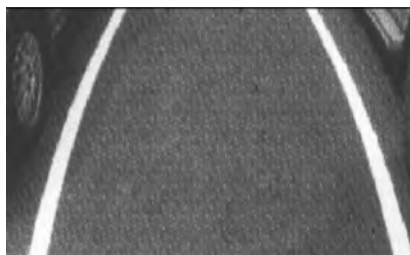
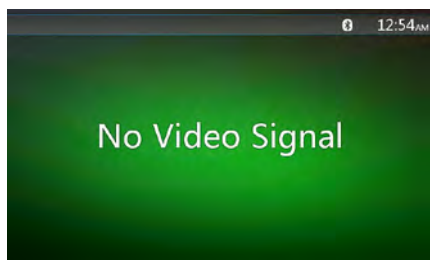

Note:

If the reverse cable is connected correctly to the car, the unit goes to camera mode automatically when the car is in reverse.

20. REAR SOURCE OPERATIONS

If a monitor is installed in the rear zone and connected to the rear zone AV output, passengers in the back seat can watch the DVD/iPod Video/AUX1/ AUX2/ TV video separately from front source.

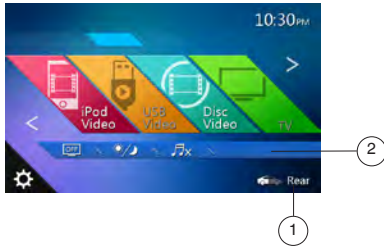

- 1 - Touch the button to access the front source.
- 2 - Touch the button to close the rear source.

Multi-Zone Operation

Independent sources can be played simultaneously on the unit. For example, a FM/AM console can be playback on the front screen while DVD video is available to rear passengers. But now can't select DVD video in front.

Access Rear-Zone

1. Touch the Rear button on Main Menu to access the Rear Source.
2. Select a source to play.

Exit Rear-Zone

Touch the 2-Zone off button to close the Rear Source.

Note:

1. If the source is selected as the front, the source in rear can't be selected.
2. If the source is selected as the rear, the source in front can't be selected.
3. Touch the Front button to access the main menu but not close the Rear Source.

DVD Video in Rear



- 1 - Option button
- 2 - Show Cursor keys
- 3 - Previous Chapter /Fast Backward button
- 4 - Play/Pause button
- 5 - Next Chapter /Fast Forward button
- 6 - Elapsed playing time
- 7 - Menu List button
- 8 - Front/Rear button

If the screen displays Rear Source, touch Front/Rear button to switch to Front Source.

If the screen displays Front Source, touch Front/Rear button to switch to Rear Source.



DVD Video Rear Source Control Info Mode



Touch BACK button to return.

DVD Video Rear Source Control Direct Mode



Note: More detail please refer to DVD Video Front source.

AUX1



AUX2



iPod Video in Rear

iPod Video Rear Source Control Play Mode

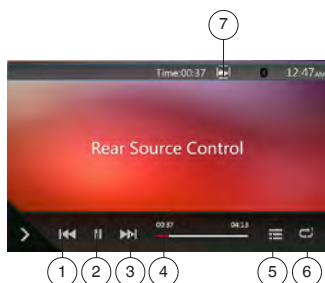

1 - Previous Track /Fast Backward button

2 - Play/Pause button

3 - Next Track/Fast Forward button

4 - Progress bar

5 - Menu List button:

Press the Menu button to display the iPod Video Rear Source mode screen.

6 - Repeat button:

Same as iPod function of front source

7 - Front/Rear button

If the screen displays Rear Source, touch to switch to Front Source.

If the screen displays Front Source, touch to switch to Rear Source.

iPod Video Rear Source ID3 Mode

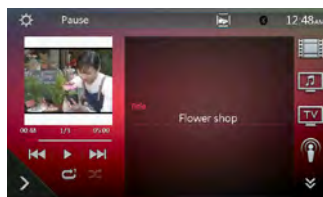

Note:

If the source is selected as the front, the source in rear can't be selected.

If the source is selected as the rear, the source in front can't be selected.

Touch the Front button to access the front main menu but the rear source will keep running.

21. SETTING OPERATIONS

Touch [] button on the Main menu screen. The Setting menu screen will be displayed.

General Setup Menu



System Language: Set the Language for system screen.

Shortcut Menu: Select menu to be able to select from Shortcut menu and drag it to lower side area.



Time: Set system clock.

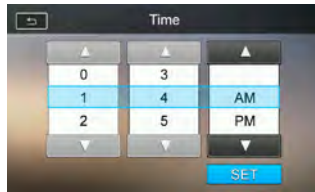

24-Hour Format: Set the time display mode.

Beep: Turn on or turn off the beep confirmation sound.

Bluetooth: Set the Bluetooth On or Off.

Wallpaper: Choose the desired wallpaper.

There are three optional images, which you can import from USB. Select "Imported 1/2/3" and touch [Import]. The format should be jpeg of less than 5M bytes.



Illumination Color: Set the illumination color on the panel.

Input Aux Sense: AUX input switch, including Low, Middle, High.

Tel Speaker: There are two options, Left and Right. For example, if current setting is Right, when BT phone is coming in, only right speaker can hear the phone.

Version: Display the software version information.

Note:

- Time and 24-Hour Format can be adjusted when set the system time not to be synchronized with GPS local time.

Video Setup Menu



DVD Wide Screen Mode: Set the DVD wide screen mode On or Off.

Dimmer: Set Dimmer value from 0 to 20.

Dimmer Mode: There are three options, Day, Night and Auto.

Audio Setup Menu

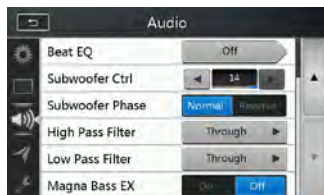
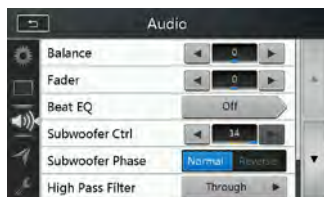

Balance: Choose the desired volume for left and right speaker.

Fader: Choose the desired volume for front and rear speaker.

Beat EQ: Choose the desired mode: Bass Boost, Impact, Excite, Custom and OFF.

Subwoofer Ctrl: Choose the desired subwoofer gain from 0 to 14.

Subwoofer Phase: Choose the Subwoofer Phase normal or reverse.

High Pass Filter: Choose the frequency about the high pass filter or enable. The frequencies include 60Hz, 90Hz and 120Hz.

Low Pass Filter: Choose the frequency about the low pass filter or enable. The frequencies include 60Hz, 90Hz and 120Hz.

Magna Bass EX: Choose the loudness On or Off.

Note:

Optional cable (sold separately) is necessary when you use Audio line out.

Navigation Setup Menu

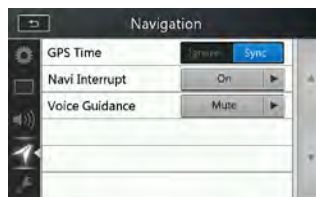

GPS Time: Set the system time to be synchronized with GPS local time or not.

Navi Interrupt: There are three choices: On/Popup/Off.

“On”: The navigation screen will cover to AV screen when reaching some key point. “Popup”: When small turn info window will pop up in the top of the AV screen to indicate the key point. “Off”: Turn off this function.

Voice Guidance: There are three choose: On/Mute/Off.

On: Interrupt function of voice guidance is on. While interrupting no attenuate function of AV sound.

Mute: Interrupt function of voice guidance is on. While interrupting attenuate function sound is on.

Off: Disable the navigation voice guidance.

Others Setup Menu

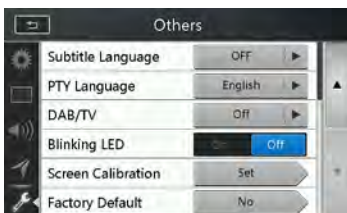
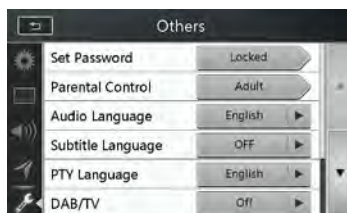



Set Password: Set the password for DVD parental control.

Parental Control: Set the rating of the age. It contains Kid Safe/G/PG/PG-13/PG-R/R/NC-17/Adult.

- Audio Language:** Set the Language for DVD Audio.
- Subtitle Language:** Set the Language for DVD subtitle.
- PTY Language:** Set the Language for PTY text.
- DAB/TV:** Choose the connected device: DAB, TV and Off.
- Blinking LED:** Set blinking LED On or Off.
- Screen Calibrate:** The function of it is to select the TS Calibrate YES or NO.
- Factory Default:** The function is to select to load factory default or not.

Set the Anti-Theft Code

1. If your unit is unlocked, hold the  button more than 2 seconds, then the Anti-Theft setting mode will display. Users can change anti-theft code.
 - Touch **[YES]** button, the numerical keypad is displayed. Enter the new password twice, then anti-theft code is set and your unit is secured. When the Anti-theft is "On", you need enter correct Anti-theft code to turn the unit on. If you enter wrong code three times, the unit is locked, and must be unlocked by the professionals.
2. If your unit is secured, hold the  button more than 2 seconds, then the Anti-Theft setting mode will display. The numerical keypad is displayed, enter the right code to unlock.

Note:

If the anti-theft code is lost or forgotten, a charge will be incurred at the owner's expense by a Clarion service station to unlock the NX405E.

22. TROUBLESHOOTING

General

| Problem | Cause | Measure |
|---|---|--|
| Power does not turn on. (No sound is produced.) | Fuse is blown. | Replace with a fuse of the same amperage. If the fuse blows again, consult your store of purchase. |
| | Incorrect wiring. | Consult your installation center. |
| Nothing happens when buttons are pressed. Display is not accurate. | The microprocessor has malfunctioned due to noise, etc. | Press the reset button with a thin rod. Note: <i>When the Reset button is pressed, turn off the ACC power.</i> * When the Reset button is pressed, frequencies of radio stations, titles, etc. stored in memory are cleared. |
| The remote control unit does not work. | Direct rays of the sun fall on the light-receptive part of the remote control unit. | When direct rays of the sun fall on the light-receptive part of the remote control unit, it may not work. |
| | The battery of the remote control unit is dead or there is no battery in the remote control unit. | Check the battery of the remote control unit. |

DVD Player

| Problem | Cause | Measure |
|---|---|---|
| Disc cannot be loaded. | A disc is already loaded. | Eject the disc before loading the new one. |
| | There is foreign matter already in the disc slot. | Remove the foreign matter, or consult a service station. |
| Sound skips or is noisy. | Disc is dirty. | Clean the disc with a soft cloth. |
| | Disc is heavily scratched or warped. | Replace with a disc in good condition. |
| Sound is bad directly after power is turned on. | Condensation may form on the internal lens when the car is parked in a humid place. | Let dry for about 1 hour with the power on. |
| Video images are not displayed. | The parking brake is not engaged. | Check that the parking brake is engaged. |
| Disc cannot play with the display "PARENTAL VIOLATION" shown. | Feature exceeds set parental level. | Release the view limitation or change the parental level. See the subsection "Setting up the parental level" |

USB Device

| Problem | Cause | Measure |
|--|--|--|
| USB device cannot be inserted. | The USB device has been inserted with wrong direction. | Reversing the connection direction of the USB device, try it again. |
| | The USB connector is broken. | Replace with a new USB device. |
| USB device is not recognized. | The USB device is damaged. | Disconnect the USB device and reconnect. If the device is still not recognized, try replacing with a different USB device. |
| | Connectors are loose. | |
| No sound heard with the display "NO FILE" shown. | No MP3/WMA file is stored in the USB device. | Store these files properly in the USB device. |
| Sound skips or is noisy. | MP3/WMA files are not encoded properly. | Use MP3/WMA files encoded properly. |
| The video image of iPod/iPhone is disturbed. | The TV Signal setting of the iPod/iPhone is not set correctly. | Set the TV Signal setting (NTSC/PAL) of the iPod/iPhone correctly. |

Bluetooth

| Problem | Cause | Measure |
|---|---|--|
| Cannot pair the Bluetooth enable device with the car audio system. | The device does not support the profiles required for the system. | Use another device to connect. |
| | The Bluetooth function of the device is not enabled. | Refer to the user manual of the device for how to enable the function. |
| The audio quality is poor after connection with a Bluetooth enabled device. | The Bluetooth reception is poor. | Move the device closer to the car audio system or remove any obstacle between the device and the system. |

TFT Screen

| Problem | Cause | Measure |
|---|--------------------------------------|---|
| The image is not displayed. | The parking brake is not engaged. | Check that the parking brake is engaged. |
| The display is dark. | The Dimmer control is too low. | Adjust the Dimmer properly. |
| | The operating condition is not good. | The temperature inside the vehicle may be 0°C or lower. Set to an appropriate temperature (25°C or so) and check it again. |
| | The headlight of the vehicle is lit | The display is made dark at night to prevent the glare (When the headlight of the vehicle is lit in the daytime, the display gets dark). |
| There are red, green, and blue points in display. | ----- | This is not a failure, but a phenomenon peculiar to a liquid crystal panel (The liquid crystal panel is produced according to technology with very high precision. Note that, though there are effective pixels of 99.99% or more, pixel missing or normally lit pixels account for 0.01%). |

23. ERROR DISPLAY

If an error occurs, one of the following displays is displayed.

Take the measures described below to solve the problem.

DVD Player

| Display | Cause | Measure |
|---------------------------|--|---|
| BAD DISC | A disc cannot be played due to scratches, etc. | Replace with a non-scratched, non-warped disc. |
| Invalid Disc | A disc is loaded upside- down inside the DVD deck and does not play. | Eject the disc then reload it properly. |
| PARENTAL VIOLATION | Parental level error | Set the correct Parental level. |
| Region code error | Region code error | Eject the disc, and replace correct region code disc. |

24. SPECIFICATIONS

FM Tuner

Frequency Range: 87.5MHz to 108.0MHz

Usable Sensitivity: 8 dB μ V

Stereo Separation: 25 dB (1KHz)

Frequency Response: 30Hz to 14KHz

AM Tuner

Frequency Range: 531KHz to 1602KHz

Usable Sensitivity: 30dB μ V

DVD Player System

Digital Versatile Disc System with CDDA capable

Usable discs:

DVD video disc, Compact disc

Frequency Response: 20Hz to 20KHz

Signal/Noise Ratio: 88dBa (1W Ref)

Distortion: 0.05%

Video system: NTSC/PAL

Audio/Video Input

Audio input voltage: ≤ 2 Vrms

Video input voltage: 1.0 Vp-p@75 Ω

Audio input sensitivity (at 1 V output)

High: 325mVrms

Mid: 650mVrms

Low: 1.3Vrms

Audio/Video output

Video output voltage: 1.0 Vp-p @75 Ω

Screen Size: 6.0" wide type

Pixels: 1,152,000

Resolution: 800 x 480 x 3 (RGB)

Bluetooth

Specification: Bluetooth Ver 2.1+EDR

Profile: HFP1.5(Hands Free Profile)

HSP1.0 (Headset Profile)

A2DP (Advanced Audio Distribution Profile)

AVRCP1.2,1.3 (AV Remote Control Profile)

PBAP (Phone Book Access Profile)

SPP (Serial Port Profile)

Power Class: 2

USB

Specification: USB 1.1/2.0 (FS)

Playable Audio format:

MP3, WMA, AAC, FLAC

Playable Video format:

AVI, MP4, MPG/MPEG, 3gp

General

Power source voltage:

14.4 VDC (10.8 to 15.6 V allowable)

Ground: Negative

Current consumption: 4.0 A @1 W

Auto Antenna Rated Current: 500 mA less

Audio Amplifier

Maximum power output: 180W (45W x 4)

Speaker impedance: 4 Ω (4 Ω to 8 Ω allowable)

Note:

- Specifications and design are subject to change without notice for further improvement.

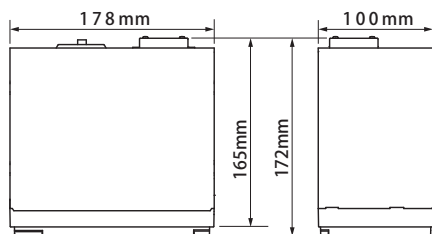

NX405E dimensions:

NX405E weight: 2.3 kg

25. WIRE CONNECTION GUIDE

Note:

- Before installing, be sure to disconnect the negative cable of the car battery.
- In the optional devices, the RCA cables and the Connector cables are separately-sold items.
- When connect the HDMI and USB cable, be sure to fix with the clamp.

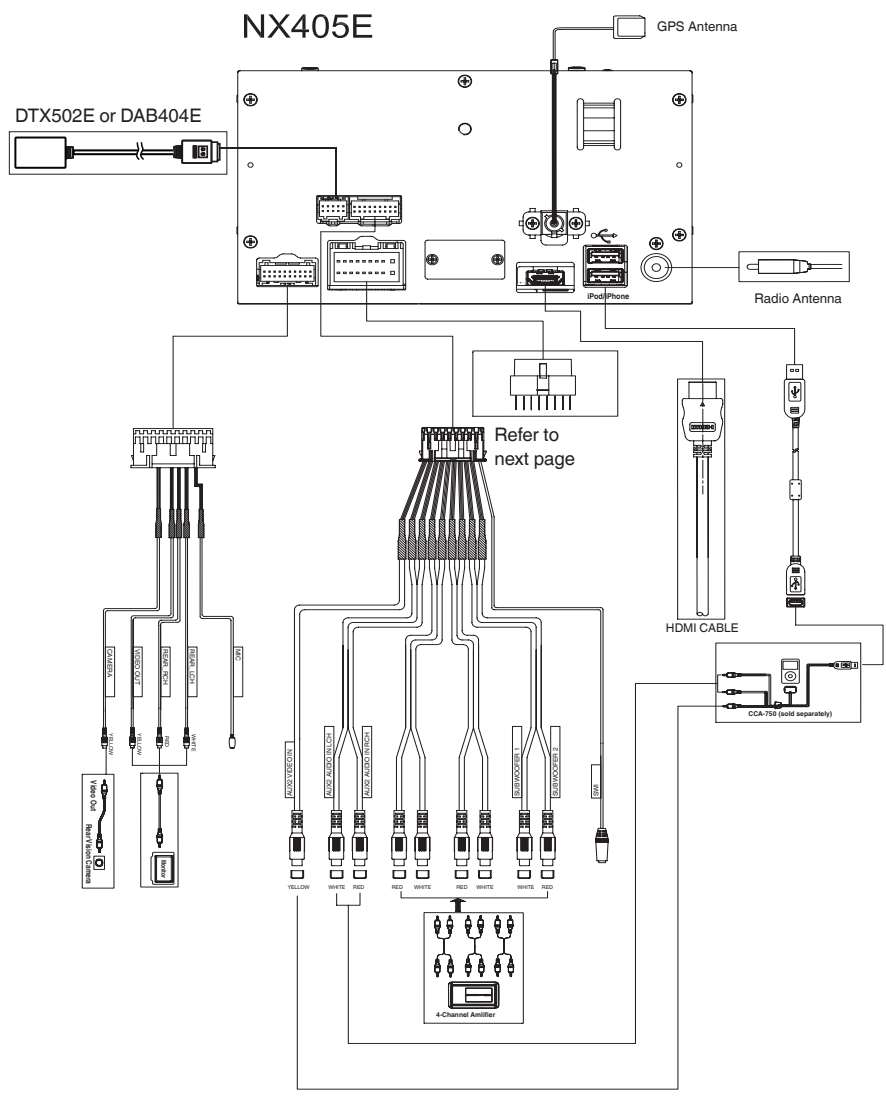

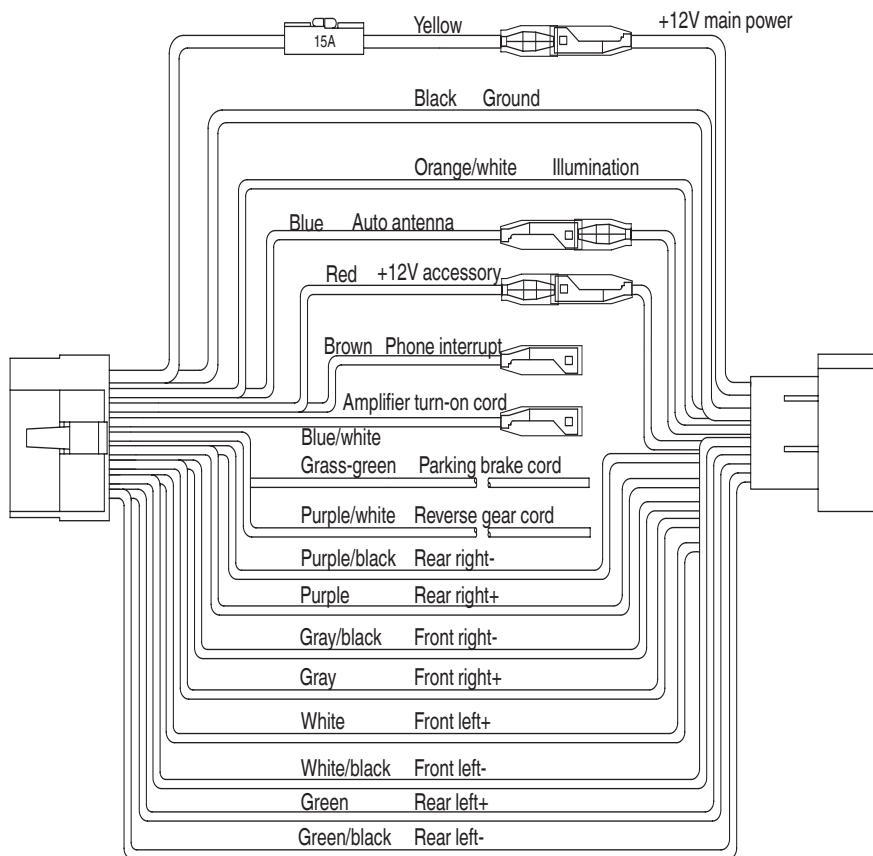
**Note:**

*1: Connecting the PHONE INTERRUPT terminal
 The phone interrupt will mute the audio if the lead receives a negative or ground signal.

Clarion Co., Ltd.

All Rights Reserved. Copyright © 2015: Clarion Co., Ltd.

clarion®

Owner's manual

NX405E

English

■ **Navigation**

Table of contents

| | |
|--|-----------|
| 1 Warnings and safety information | 5 |
| 2 Getting started | 6 |
| 2.1 Initial set-up | 6 |
| 2.2 Screen controls..... | 7 |
| 2.2.1 Using the buttons and other controls..... | 8 |
| 2.2.2 Using the cursor | 8 |
| 2.2.3 Using the keyboard | 8 |
| 2.2.4 Using touch gestures | 10 |
| 2.2.5 Manipulating the map | 11 |
| 2.3 Navigation view | 12 |
| 2.3.1 Streets and roads | 14 |
| 2.3.2 GPS position markers | 14 |
| 2.3.3 The planned route | 15 |
| 2.3.4 Turn preview and next street..... | 15 |
| 2.3.5 Manoeuvre icons..... | 16 |
| 2.3.6 Lane information and signposts | 17 |
| 2.3.7 Junction view | 17 |
| 2.3.8 Tunnel view | 18 |
| 2.3.9 Motorway services..... | 18 |
| 2.3.10 3D object types | 19 |
| 2.3.11 Traffic events | 19 |
| 2.4 Navigation menu | 20 |
| 3 Using the navigation..... | 22 |
| 3.1 Selecting a destination | 22 |
| 3.1.1 Using combined search..... | 22 |
| 3.1.2 Selecting an address..... | 25 |
| 3.1.2.1 Entering an address with states | 25 |
| 3.1.2.2 Entering an address starting with the street name..... | 28 |
| 3.1.2.3 Selecting a town centre | 30 |
| 3.1.2.4 Selecting the midpoint of a street..... | 31 |
| 3.1.2.5 Selecting an intersection in a town | 32 |
| 3.1.2.6 Using the postcode to select a destination | 33 |
| 3.1.3 Selecting a Place of Interest..... | 34 |
| 3.1.3.1 Using Quick search categories | 34 |
| 3.1.3.2 Searching by category..... | 36 |
| 3.1.3.3 Searching by name..... | 38 |
| 3.1.3.4 Finding help nearby..... | 39 |
| 3.1.4 Selecting a Saved Location..... | 40 |
| 3.1.5 Selecting a History item..... | 41 |
| 3.1.6 Selecting a saved route | 43 |

| | |
|---|-----------|
| 3.1.7 Entering coordinates | 44 |
| 3.1.8 Selecting a location on the map | 45 |
| 3.1.9 Planning a Multipoint Route | 46 |
| 3.2 <i>Checking Route Information and Alternatives</i> | 47 |
| 3.3 <i>Checking Traffic Events</i> | 48 |
| 3.4 <i>Editing the route</i> | 50 |
| 3.4.1 Setting a new starting point..... | 50 |
| 3.4.2 Adding an additional destination | 51 |
| 3.4.3 Modifying the list of destinations | 52 |
| 3.4.4 Saving the planned route..... | 52 |
| 3.4.5 Deleting the planned route | 53 |
| 3.4.6 Selecting a route alternative when planning the route | 54 |
| 3.4.7 Selecting a route alternative for an existing route..... | 55 |
| 3.4.8 Pausing guidance | 56 |
| 3.5 <i>Saving a location</i> | 56 |
| 3.5.1 Editing a saved location | 57 |
| 3.6 <i>Adding an Alert Point</i> | 58 |
| 3.7 <i>Running a Simulation</i> | 59 |
| 3.8 <i>Off-road navigation</i> | 60 |
| 3.8.1 Switching to off-road navigation | 60 |
| 3.8.2 Selecting the destination in off-road mode | 60 |
| 3.8.3 Navigating in off-road mode..... | 60 |
| 4 Reference guide | 62 |
| 4.1 <i>Concepts</i> | 62 |
| 4.1.1 2D/3D GPS reception | 62 |
| 4.1.2 Natural and TTS voices | 62 |
| 4.1.3 Road safety cameras and other proximity Alert Points..... | 62 |
| 4.1.4 Route calculation and recalculation | 63 |
| 4.1.5 Smart Zoom | 63 |
| 4.1.6 Speed limit warning | 64 |
| 4.1.7 Real-time traffic | 64 |
| 4.1.8 Intelligent navigation | 65 |
| 4.1.8.1 Congestion detour on highways..... | 65 |
| 4.1.8.2 Real-time alternative routes..... | 65 |
| 4.1.8.3 Parking around destination | 66 |
| 4.1.8.4 Hints upon detour | 66 |
| 4.2 <i>Useful Information menu</i> | 67 |
| 4.2.1 Where Am I | 68 |
| 4.2.2 Trip Monitor | 69 |
| 4.3 <i>Settings menu</i> | 70 |
| 4.3.1 Route preferences settings | 71 |

| | |
|---|-----------|
| 4.3.1.1 Vehicle profile..... | 71 |
| 4.3.1.2 Route Planning Method types | 72 |
| 4.3.1.3 Navigation Mode..... | 73 |
| 4.3.1.4 Road types..... | 73 |
| 4.3.2 Sound settings | 74 |
| 4.3.3 Warnings settings..... | 75 |
| 4.3.4 Navigation View settings..... | 76 |
| 4.3.5 Regional settings..... | 78 |
| 4.3.6 Display settings..... | 79 |
| 4.3.7 Traffic settings | 79 |
| 4.3.8 Trip Monitor settings | 80 |
| 4.3.9 Usage Reports settings..... | 80 |
| 5 Troubleshooting..... | 81 |
| 5.1 GPS signal cannot be received | 81 |
| 5.2 Address cannot be found..... | 81 |
| 5.3 The calculated route is not optimal..... | 81 |
| 5.4 Disabling the speed limit warning | 82 |
| 5.5 Keyboard buttons are greyed out..... | 82 |
| 5.6 The map is hidden behind an image of a junction | 83 |
| 6 End-user licence agreement | 84 |
| 7 Copyright note..... | 92 |

1 Warnings and safety information

The navigation system helps you find your way to your destination with the built-in GPS receiver. NX405E does not transmit your GPS position; others cannot track you.

NX405E collects usage information and GPS logs that may be used for improving the application and the quality of maps if you accept it when first using the application. The data are processed anonymously; no one is able to track any personal information. If you change your mind later, you can enable or disable the log collection in Settings (page 80).

It is important to look at the display only when it is safe to do so. If you are the driver of the vehicle, we recommend that you plan and review your route before you start your journey. Plan the route before your departure and stop if you need to change the route.

You must follow the traffic rules. If you deviate from the planned route, NX405E changes the instructions accordingly.

For more information, see the end-user licence agreement (page 84).

2 Getting started

NX405E is optimised for in-car use. You can use it easily by tapping the screen buttons and the map with your fingertips.

Latest Map Guarantee

When you start using the product, you have 30 days to download the latest available map free of charge.

2.1 Initial set-up

When using the navigation software for the first time, an initial set-up process starts automatically.

1. Select your preferred language, then tap  to confirm your selection. Later you can change it in Regional settings (page 78).

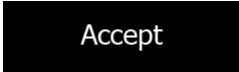

2. Read the end-user licence agreement, and tap  if you agree with the terms of use.

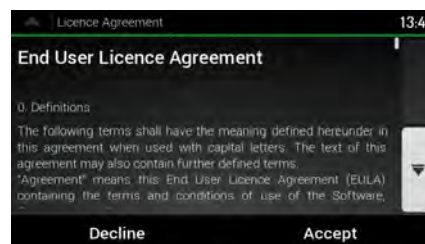

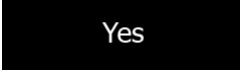
3. You are now asked whether you allow the software to collect usage information and GPS logs that may be used for improving the application and the quality of maps. Tap  to allow the anonymous statistics or disable this function. Later you can turn them on or off individually in Usage report settings (page 80).

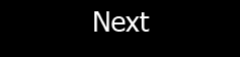
4. The Configuration Wizard starts. Tap  to continue.

5. Select the language and speaker used for voice guidance messages. Later you can change it in Regional settings (page 74). Tap **Next** to continue.



6. If needed, modify the time format and unit settings. Later you can change them in Regional settings (page 78). Tap **Next** to continue.



7. If needed, modify the default route planning options. Later you can change them in Route Preferences (page 71). Tap **Next** to continue.



8. The initial set-up is now complete, tap **Finish** to enter the Navigation view.

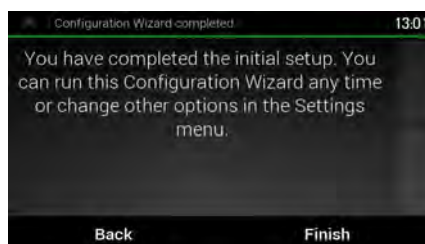

2.2 Screen controls

The following sections describe the functionality and use of buttons, sliders, and other screen controls in NX405E.

2.2.1 Using the buttons and other controls

To operate NX405E, tap the buttons on the touch screen.

The Navigation menu may contain several menu items on one or more pages.

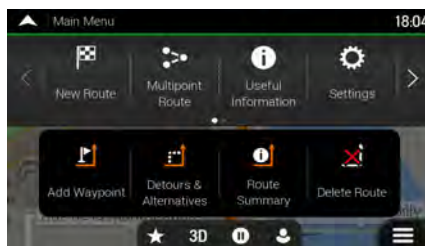

You need to confirm selections or changes only if the application needs to be restarted, if it needs to perform a major reconfiguration, or if you are about to lose some of your data or settings. Otherwise, NX405E saves your selections and applies the new settings without confirmation as soon as you use the controls.

2.2.2 Using the cursor

You can select a map location in the following ways:

- By tapping the map when navigating
- By tapping the map when you are asked to confirm the destination at the end of a search.



When a map location is selected, the cursor () appears at the selected point on the map.







The location of the cursor can be used as the destination of the route or a new Alert Point. You can also search for Places around it or add this location to your saved locations.

You can also select some of the objects on the map. If you tap the map at the icon of a Place or traffic event, the object is selected, and you can get information about this object or use it as a route point.

2.2.3 Using the keyboard











You can type with your fingertips on the screen keyboards and you can switch between various keyboard layouts, for example English, Greek or numerical. Only those keyboard buttons are active that can be used to type a name that is available on the map. The other keys are greyed out.

| Action | Function |
|--|---|
| Switching to another keyboard layout, for example from an English keyboard to a Greek keyboard | Tap  and select the new keyboard layout from the list. |

| | |
|---|--|
| <p>Correcting your entry on the keyboard</p> | <p>Tap  to remove the unnecessary character(s). Tap and hold the button to delete several characters or the entire input string.</p> |
| <p>Entering a space, for example between a first name and a family name or in multi-word street names</p> | <p>Tap the  button at the bottom centre of the screen.</p> |
| <p>Entering upper and lower case letters</p> | <p>By default, when entering a text, the first character appears in upper case while the rest of the text is in lower case. Tap  to enter an upper case letter or tap it twice to turn on Caps Lock. Tap again to use lower case letters.</p> |
| <p>Entering numbers and symbols</p> | <p>Tap  to switch to a keyboard offering numbers and symbols.</p> |
| <p>Finalising the keyboard entry</p> | <p>Tap .</p> |
| <p>Starting a search for a keyboard entry</p> | <p>Tap .</p> |
| <p>Hiding the keyboard</p> | <p>Tap .</p> |

2.2.4 Using touch gestures

You usually need to tap the screen only once. However, some useful features can be accessed with other gestures. See the table below.







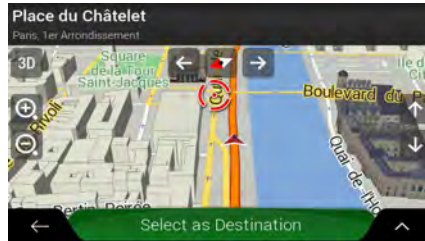



| Action | Function |
|--------------------------------|---|
| Tapping and holding the screen | <p>Tap and keep pressing the following buttons to reach extra functions:</p> <ul style="list-style-type: none"> • Tap and hold the following button on list and menu screens to show the Navigation view: . • Tap and hold any of the following buttons on the Navigation view to rotate, tilt, or scale the map continuously: , , , , , . • Tap and hold the following button on keyboard screens to quickly delete several characters: . • Tap and hold the following buttons in long lists to scroll pages continuously: , . |
| Dragging | <p>Drag the screen in the following cases:</p> <ul style="list-style-type: none"> • To move the handle on a slider. • To scroll a list: grab the list anywhere and slide your finger up or down. Depending on the speed of the sliding, the list scrolls faster or slower, only a bit or till the end. • To move the map in map browsing mode: grab the map, and move it in the desired direction. |
| Using pinch zoom | Use pinch zoom on the Navigation view to zoom in and out by moving two fingers in a pinch gesture. |





2.2.5 Manipulating the map

If you tap the map anywhere during navigation, the map stops following the current position (the blue arrow is not locked in a fix position on the screen anymore) and control buttons appear to help you modify the map view.



You can perform the following actions on the map:

| Action | Button(s) | Function |
|---------------------------------------|---|---|
| Checking location information | No buttons | The top section of the Navigation view shows information about the selected point (the cursor ). |
| Moving the map by dragging | No buttons | Move the map in any direction: tap and hold the map and move your finger towards the direction you want to move the map. |
| Zooming in and out |  ,  | Change how much of the map is displayed on the screen. NX405E uses maps that let you examine the locations at various zoom levels, always with optimised content. It always displays street names and other text with the same font size, never upside-down, and you only see the streets and objects that you need. Map scaling has a limit in 3D map view mode. If you zoom out further, the map switches to 2D view mode. Tap once to modify the view in a large step, or tap and hold the button to modify it continuously and smoothly. |
| Tilting up and down |  ,  | Change the vertical view angle of the map in 3D mode. Tap once to modify the view in a large step, or tap and hold the button to modify it continuously and smoothly. |
| Rotating left and right |  ,  | Changes the horizontal view angle of the map. Tap once to modify the view in a large step, or tap and hold the button to modify it continuously and smoothly. |
| Changing 2D, 3D, or 2D North up views |  ,  ,  | Switch between the 3D perspective, 2D Heading up, and 2D North up map view modes. In Heading up mode the map is rotated so its top always points in the current driving direction. This is the default orientation in 3D map view mode. In North up mode, the map faces North. |

| | | |
|--------------------------------|---|--|
| Checking the compass |  | The direction of the compass shows North. |
| Returning to normal navigation |  | Move the map back to follow the current GPS position. Automatic map rotation is also re-enabled. The map manipulation buttons disappear and the navigation continues. |
| Selecting additional options |  | Open a list of additional features like saving a location, or searching for Places around the cursor. |
| Selecting a destination |  | Select the cursor location as a new destination. The route is automatically calculated. |

2.3 Navigation view

The navigation view is the main screen of NX405E that shows the planned route on a map. NX405E works with digital maps which are not simply the computerised versions of traditional paper maps. Similarly to paper road maps, the 2D mode of digital maps shows you streets and roads. Elevation is also illustrated in colour.

The navigation view displays the following screen buttons, data fields, and route information on the map during navigation:



 **Note!** Some buttons, fields, or icons may not be available in your product version.

| Number | Name | Description |
|---------------|-----------------------------------|---|
| 1 | Current position marker | The current position is displayed as a blue arrow by default. When there is no GPS position, the current position marker is transparent and it shows your last known position. See page 14. |
| 2 | GPS position | The dot near the arrow shows the GPS position as perceived by the GPS receiver. See page 14. |
| 3 | Planned route | The planned route is displayed as an orange line. |
| 4 | Data fields | <p>Three data fields show the following information:</p> <ul style="list-style-type: none"> • The estimated time of the arrival at the destination • The remaining time of the trip • The remaining distance to the destination. <p>By tapping it, you can access additional information about the current trip on a dashboard screen and in the Trip Summary.</p> <p>You can change the default values in Settings (page 76) or by tapping and holding the area where the data fields appear.</p> <p>If you have not selected a destination, you can see your heading instead of the three data fields.</p> |
| 5 | Next turn preview | It shows the type of the next manoeuvre and its distance. See page 15. |
| 6 | Second next turn preview | It shows the type of the second next manoeuvre if it is near the first one. See page 15. |
| 7 | Next street | <p>It displays the name of the next street. See page 15.</p> <p>If you have not selected a route destination, you can see nearby house numbers.</p> |
| 8 | Parking around destination | It appears near the destination. By tapping it, you can check the available parking facilities around your destination. See page 66. |
| 9 | Destination menu | It appears near the destination. By tapping it, you can check the trip summary, find Places around your final destination, save the current location, or suspend the navigation. |
| 10 | Traffic | It shows traffic-related information. See page 48. |
| 11 | Lane information | On multi-lane roads, it shows the lanes ahead and their directions. The highlighted arrows represent the lanes and direction you need to take. See page 17. |
| 12 | Alert point warning | It shows the type of the alert points when approaching a road safety camera or other Alert Points like school zones or railroad crossings. You must make sure that using this feature is legal in the country where you intend to use it. See page 75. |
| 13 | Speed limit warning | It shows the current speed limit of the road. See page 75. |
| 14 | Warning road sign | It shows warning for the current road (for example, dangers, sharp curves). See page 75. |

| | | |
|----|--------------------------|--|
| 15 | Signpost | It shows the available destinations and the road numbers. See page 17. |
| 16 | Motorway services | By tapping it, you can check the details of the next few service stations (petrol stations, restaurants) when travelling on a motorway. See page 18. |
| 18 | Navigation menu | By tapping it, you can open the Navigation menu, where you can reach other parts of NX405E. |
| 19 | Street name | It shows the current street name. By tapping it, you can open the Where Am I screen. See page 68. |
| 20 | 3D objects | They display hills, mountains, roads, landmarks, and buildings in 3D. |

If you are approaching a motorway exit or a complex intersection and the needed information exists, the map is replaced with a 3D view of the junction. See page 17.



When entering a tunnel, the map is replaced with a generic tunnel image. See page 18.



2.3.1 Streets and roads

NX405E shows the streets similarly to paper road maps. Their width and colours correspond to their importance; you can easily tell a motorway from a small street.

2.3.2 GPS position markers



When your GPS position is available, NX405E marks your current position. By default, this marker is a blue arrow. The dot near the arrow shows the GPS position as perceived by the GPS receiver.

When on-road navigation is selected, the current position marker may not show your exact GPS position and heading. If roads are near, it is aligned to the nearest road to eliminate GPS position errors, and the direction of the icon is aligned to the direction of the road.

If you select off-road navigation, the current position marker is at your exact GPS position. The direction of the icon shows your current heading.

2.3.3 The planned route

The planned route is the currently navigated route. Whenever the destination is set, the route is active until you delete it, reach your destination or suspend navigation. NX405E displays the route in the following ways:

| Symbol | Name | Description |
|---|---|---|
|  | Current GPS position and starting point | <p>It is your current position displayed on the map.</p> <ul style="list-style-type: none"> • In pedestrian mode it is the GPS position. • If a vehicle is selected for route calculation and roads are near, the arrow jumps to the nearest road. • The dot near the arrow shows the exact GPS position. <p>Normally, if GPS position is available, the route starts from the current position. If there is no valid GPS position, NX405E uses the last known position as the starting point.</p> |
|  | Waypoint (intermediate destination) | It is an intermediate destination of the route before reaching the final destination. |
|  | Destination (end point) | It is the final destination of the route. |
| | Route colour | The route always stands out with its colour on the map, both in daytime and night colour modes. |
| | Streets and roads that are excluded from the navigation | You can choose whether you want to use or avoid certain road types (page 71). However, when NX405E cannot avoid such roads, the route includes them and shows them in a colour that is different from the route colour. |
| | Streets and roads that are affected by traffic events | Road segments may be affected by traffic events. These streets and roads are displayed in a different colour, and small symbols displayed along the route show the type of the traffic event. |

2.3.4 Turn preview and next street

When navigating a route, the top section of the Navigation view shows information about the next route event (manoeuvre) and the next street or the next town.

















There is a field in the top left corner displaying the next manoeuvre. Both the type of the manoeuvre (turn, roundabout, exiting motorway, and so on) and its distance from the current position are displayed.

A smaller icon shows the type of the second next manoeuvre if it is near the first one. Otherwise, only the next manoeuvre is displayed. Tap the icon of the actual manoeuvre to open the Itinerary screen.

2.3.5 Manoeuvre icons

During navigation the next manoeuvre is displayed in the top left corner. Most of the manoeuvre icons are intuitive. The following table lists some of the frequently shown route events:

| Icon | Function |
|---|--|
|  | Turn left. |
|  | Turn right. |
|  | Turn back. |
|  | Bear right. |
|  | Turn sharp left. |
|  | Keep left. |
|  | Continue straight in the intersection. |
|  | Enter the roundabout and take the first exit (next manoeuvre). |
|  | Enter the roundabout (second next manoeuvre). |
|  | Enter the motorway. |
|  | Exit the motorway. |
|  | Board the ferry. |
|  | Leave the ferry. |
|  | Approaching a waypoint on the right. |
|  | Approaching the destination. |

2.3.6 Lane information and signposts

When navigating on multi-lane roads, it is important to take the appropriate lane in order to follow the planned route. If lane information is available in the map data, NX405E displays the lanes and their directions using small arrows at the bottom of the map. Highlighted arrows represent the lanes and the direction you need to take.

Where additional information is available, arrows are replaced by signposts. Signposts are displayed at the top of the map. The colour and style of the signposts are similar to the real ones you can see above roads or by roadsides. They show the available destinations and the road numbers.

All signposts look similar when cruising (when there is no planned route). During navigation only the signpost that points to the lane(s) to be taken is highlighted; all the others are darker.

If you want to hide the currently displayed signposts, tap any of them and the normal Navigation view returns until new signpost information is received.

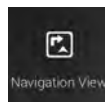

You can modify the signpost settings in [Navigation View](#) (page 76).

2.3.7 Junction view

If you are approaching a motorway exit or a complex intersection and the needed information exists, the map is replaced with a 3D view of the junction. The lanes you need to take are displayed with arrows. At the top of the screen, road signs show you additional information.

If you want to hide the currently displayed junction and return to the Navigation view, tap the picture.

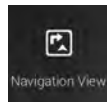

Junction view can be turned off in [Navigation View](#). See page 76.

2.3.8 Tunnel view

When entering a tunnel, the map is replaced with a generic tunnel image so that surface roads and buildings cannot distract you.



The top-down overview of the tunnel displayed in a separate window helps you orientate yourself. The remaining distance in the tunnel is also displayed.

After leaving the tunnel, the original map view returns.

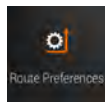

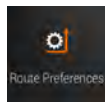
Tunnel view can be turned off in . See page 76.

2.3.9 Motorway services



When you are driving on a motorway, the  button appears at the top right corner of the Navigation view. Tap it to open a panel with the details of the next few service stations (petrol stations, restaurants).

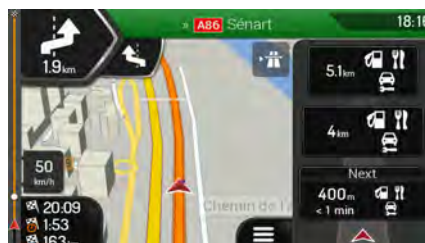

Tap any of them to display the exit area on the map. You can now easily add this service station as a waypoint to your route if necessary.

If you want to display other types of Places at the next few service stations, you can change

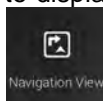

the icons in . See page 76.

2.3.10 3D object types

NX405E supports the following 3D object types:





| Type | Description |
|----------------|--|
| 3D terrain | NX405E displays 3D hills and mountains in the Navigation view, and illustrates them by colouring and shading on the 2D map. |
| Elevated roads | Elevated roads are complex intersections and vertically isolated roads (such as overpasses or bridges) displayed in 3D. |
| 3D landmarks | Landmarks are 3D representations of prominent or well-known objects. |
| 3D buildings | 3D buildings are block representations of full town building data containing actual building sizes and positions on the map. |

2.3.11 Traffic events

Road segments affected by traffic events are displayed in a different colour on the map.



The following icons may appear at the top right corner of the screen:

| Button | Description |
|---|---|
|  | It is displayed when traffic events are not received. |
|  | It is displayed when traffic events are received but they do not affect the planned route. |
|  | It shows the type of the next traffic event with the expected delay. |
|  | It shows the type of the next traffic event if it does not cause any delay or the delay is not known. |



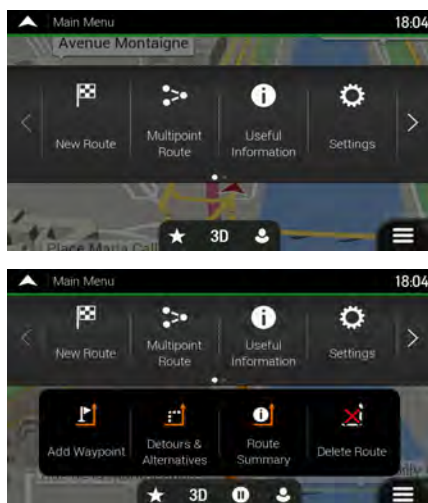

For more information, see page 48.

2.4 Navigation menu

On the Navigation view, tap  to open the Navigation menu.

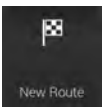

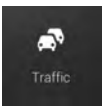

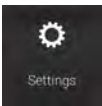
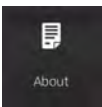
You can see the following menu options when you are navigating without a planned route:



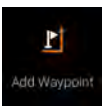
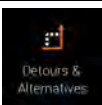

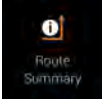

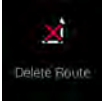
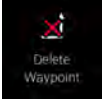
| Button | Function |
|---|--|
|  | Select your destination by entering an address or its coordinate, or by selecting a Place, a Saved Location, or a Saved Route. You can also look up your recent destinations from the History. |
|  | Build your route from one or more route points. You can also plan a route independently of your current GPS position by setting a new starting point. |
|  | Check the traffic events affecting your route, or view historical traffic data. |
|  | Access additional options and check navigation-related information. |
|  | Customise the way the navigation software works. |
|  | See information about the navigation software. |

With a planned route, the following menu options are also available:





| Button | Function |
|---|--|
|  | Add an intermediate destination to your route. |
|  | See route alternatives to avoid parts of the route, or to avoid a specific road from your planned route. |

| | |
|---|---|
|  | View the route in its full length on the map and check route parameters and route alternatives. Tap  to access additional options, like Simulation or Route Preferences. |
|  | Delete your route. |
|  | Delete the next waypoint or the whole route. |

In the navigation menu, you have the following additional options:

| Button | Function |
|---|---|
|  | Open the Saved Locations screen where you can save a location as a favourite destination or edit a saved location. |
|  | Switch to 2D () , 2D North up () view or back to 3D mode. |
|  | Suspend navigation. |
|  | Resume navigation. |
|  | Access the User profiles menu where you can create new profiles or edit the existing ones. If several drivers are using the navigation system, they can create their own profiles with their own settings. |

The following options are also available on many of the menu screens:

| Button | Function |
|---|---|
|  | The Menu button appears when the Navigation view is displayed. Tap it to open the Navigation menu. |
|  | The More button appears on the screen to display additional features. Tap it to open the list of additional features on certain screens. |
|  | Tap it to return to the map from any menu screen. |
|  | Tap the Back button to return to the previous screen. You can also press and hold this button to quickly return to the Navigation view from any other screen. |

3 Using the navigation

By default, NX405E calculates routes using the road network of the maps provided with the product.

You can select the destination and start navigating to it right away (normal navigation) if you need a route for immediate navigation.

You can also plan a route independently of your current GPS position even without GPS reception. To achieve this, you need to set a new starting point in the Multipoint Route menu. It also suspends guidance so that the route is not recalculated when a new position is received. See Page 50.

You can plan routes with multiple destinations by selecting a first and a second destination and adding it to your route. You can add as many destinations to your route as you like. See Page 46.

You can also use NX405E for off-road navigation. See page 60.

3.1 Selecting a destination

You can choose your destination by selecting one of the following options:

- Using combined search to search among different destination types at once, see page 22
- Entering a full address or a part of an address, for example a street name without a house number, see page 25
- Selecting a Place as your destination, see page 34
- Selecting a previously saved location as your destination, see page 40
- Selecting a location from the History of previously used destinations, see page 41
- Selecting a previously saved route, see page 43
- Entering the coordinate of the destination, see page 44
- Selecting a location on the map, see page 45
- Planning a multipoint route, see page 46.

3.1.1 Using combined search

There are several ways to select your destination. You can initiate a separate search for addresses, Places, saved locations, or recent destinations, but the fastest way to search for any of these is to use combined search.

Perform the following steps to use combined search:

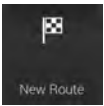
1. Tap  on the Navigation view to access the Navigation menu.
2. Tap  .

3. Tap  Search in All. You can see the input field at the top of the screen. Right next to it you can see the search area, the town around which the search is carried out. The default search area is the area where you are located. For a local search, skip the next step.

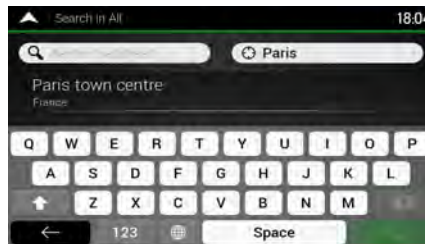

4. (optional) To search in a different area, tap the input field with the search area, and start entering the name of the new search area on the keyboard.

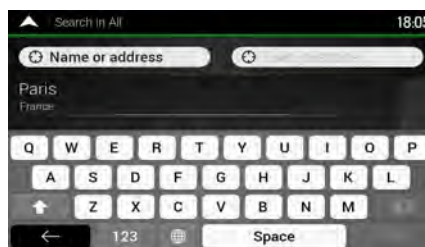

You only need to enter a few letters to get a result. The most likely result appears below the input field as you enter new letters.

- a. If the new search area is in a different country, start entering the country and the town. It is usually enough to type the first few letters of the country or town and conventional abbreviations can also be used.





- b. Tap  to see the whole list of the matching results.

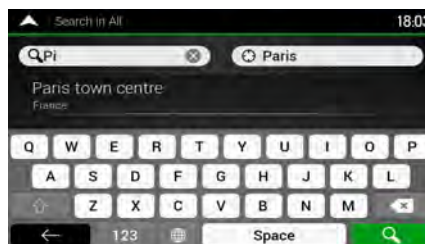

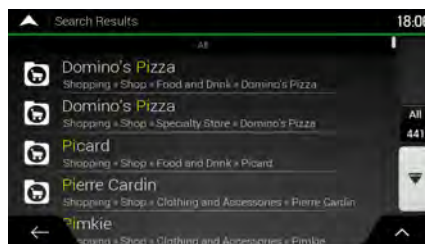

5. With the proper search area displayed, start entering the name, address, or category of the destination you are looking for.



6. Tap  to switch to the result screen. You can see all the results in the list, regardless of their type. Addresses, Places, Place categories, Saved locations, and recent destinations are mixed in one list. You can immediately select the result you want to use as your destination or narrow the list of results for only one type (for example, Places).



7. If necessary, tap  on the right side of the list and then tap the related button to narrow the list of search results by type (the number on the related icon shows the number of the matching results):

- Tap  to see the list of recent destinations with a matching name or address.
- Tap  to see the list of your saved locations with a matching name.
- Tap  to see the list of matching addresses.
- Tap  to see the list of matching Place category names. Scroll the list and select one of the categories. You get the list of Places in that category ordered by their distance from your current position.
- Tap  to see the list of matching Places ordered by their distance from your current location.
- (optional) If your product contains Places from different data providers, you can further narrow the list by showing the results from one provider only. Look for the provider logos. Tap one of them to see Places from that provider.

To search for an intersection in the combined search, enter the names of the streets connected by the '&' sign. You do not need to use spaces before and after the separator character. For example you can find the intersection of Collins Street and Douglas Avenue by entering strings, like "Collins St & Douglas Ave", "Collins & Douglas", "Col&Doug", etc. The more precise the input string is, the fewer false results are expected. If you enter "Collins St&", you get all the intersections of Collins Street and you can select the appropriate one from the result list.







Tip!



-
8. Once the destination is selected, a full screen map appears with the selected point in the middle. If necessary, tap the map somewhere else to modify the destination. The

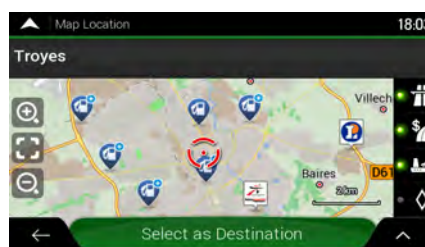

cursor () appears in the new location.

9. Check the settings for road types and change them if necessary.

Tap  to enable or avoid motorways, tap  for roads with Period Charge or Per-use Toll, tap  for ferries, or tap  for carpool lanes.



10. Tap  to confirm the destination, or tap  to select a different destination.

11. The route is calculated and the map appears showing the entire route, where you can check route information and route alternatives. Tap  to modify the route parameters, or tap  to start your journey.

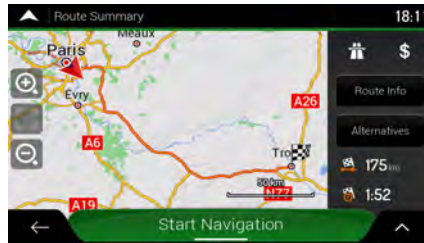

3.1.2 Selecting an address

If you know at least a part of the address, this is the quickest way to select your destination. Using the same screen, you can find an address by entering the following information:

- The exact address, including the house number, see page 25
- The address starting with the street name, see page 28
- The centre of a town, see page 30
- The midpoint of a street, see page 31
- An intersection, see page 32
- Any of the above, starting the search with the postal code, see page 33.

3.1.2.1 Entering an address with states

To enter an address as the destination, follow these steps:

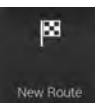
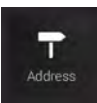
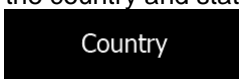
1. Tap  on the Navigation view to access the Navigation menu.
2. Tap  and .
3. By default, the NX405E proposes the country and state where you are or in case there is no valid GPS position, the country and state of the last known position. If needed, change the country. Tap .



- a. In the Select Country screen, you can immediately select a country from the list

below the input field or tap the  Enter Country Name button and start entering the first few letters of the country on the keyboard. If you select a country without a state, you can search for a town in all its states.

- b. Tap  to open the list of results and select one country from the list.

4. If needed, select a new city.

- a. Tap the City or ZIP code field.
- b. (optional) In the Select City or ZIP code screen, you can immediately select a city from the list of suggestions.



- c. Otherwise, start entering the first few letters of the city on the keyboard. The names that match the string appear in a list.

- d. To open this list, tap  and select the city.

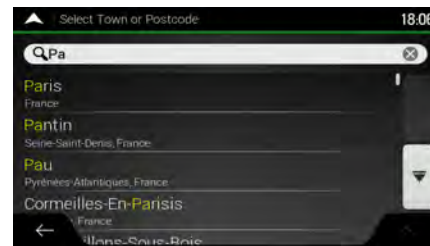

5. Enter the street name.

- a. Tap the Street field.
- b. (optional) On the Select Street screen, you can immediately select a street from the list of suggestions.



- c. Otherwise, start entering the street name on the keyboard, the names that match the string appear in a list.

- d. Tap  to open the list of results. Select the street from the list.

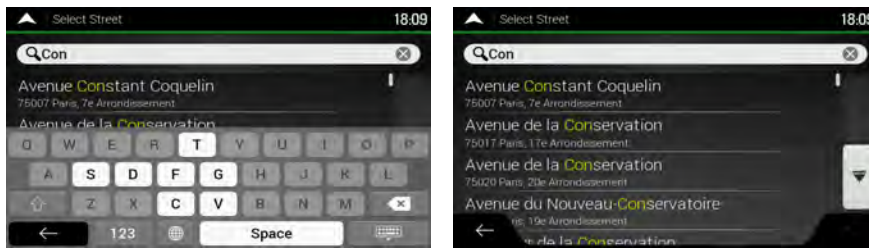

6. Enter the house number by performing the following steps:



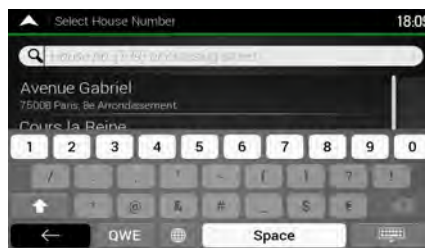

- Tap the House number or crossing street field.
- Enter the house number on the keyboard. (To enter letters, tap .)
- Tap the selected address to finish the address search.





7. A full screen map appears with the selected point in the middle. If necessary, tap the

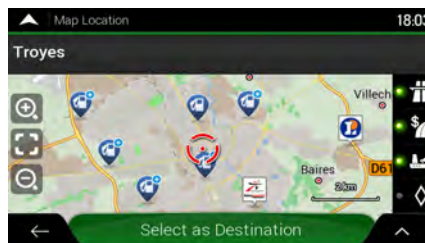

map somewhere else to modify the destination. The cursor () appears at the new location.

8. Check the settings for road types and change them if necessary.

Tap  to enable or avoid motorways, tap  for roads with Period Charge or Per-use Toll, tap  for ferries, or tap  for carpool lanes.







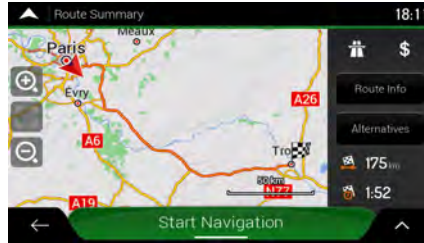

9. Tap  to confirm the destination. You can also select a nearby point on the map or tap  to select a different destination.

- The route is calculated and the map appears showing the entire route, where you can check route information and route alternatives. Tap  to modify the route parameters, or tap  to start your journey.



3.1.2.2 Entering an address starting with the street name

After you have selected the country and state, you can leave the city or ZIP code field empty and start the search with the street name. This way you can search in all streets of a state. If you select the country without a state, this function cannot work.

- Tap  on the Navigation view to access the Navigation menu.
- Tap  and .
- By default, NX405E proposes the country and state where you are. If needed, change the country. Tap .
 - In the Select Country screen, you can immediately select a country from the list below the input field or tap the  button and start entering the first few letters of the country on the keyboard.
 - Tap  to open the list of results and select one country from the list.
- If needed, select a new city.
 - Tap the City or ZIP code field.
 - (optional) In the Select City or ZIP code screen, you can immediately select a city from the list of suggestions.



- Otherwise, start entering the first few letters of the city on the keyboard. The names that match the string appear in a list.

- d. To open this list, tap  and select the city.



5. Enter the street name.

- Tap the Street field.
- (optional) On the Select Street screen, you can immediately select a street from the list of suggestions.



- Otherwise, start entering the street name on the keyboard, the names that match the string appear in a list.

- d. Tap  to open the list of results. Select the street from the list.

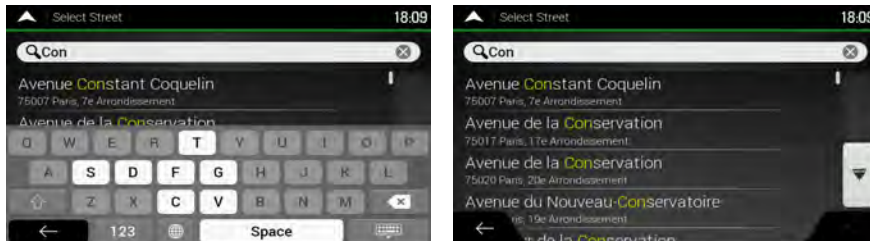

6. Enter the house number by performing the following steps:

- Tap the House number or crossing street field.
- Enter the house number on the keyboard. (To enter letters, tap .)
- Tap the selected address to finish the address search.

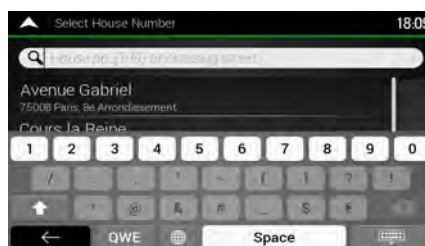



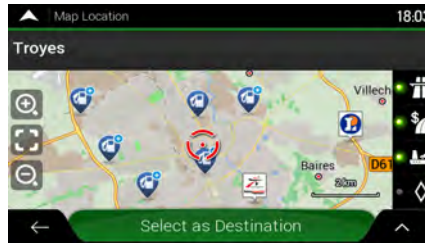

7. A full screen map appears with the selected point in the middle. If necessary, tap the map somewhere else to modify the destination. The cursor () appears at the new location.

8. Check the settings for road types and change them if necessary.

Tap  to enable or avoid motorways, tap  for roads with Period Charge or Per-use Toll, tap  for ferries, or tap  for carpool lanes.



9. Tap  to confirm the destination. You can also select a nearby point on the map or tap  to select a different destination.

10. The route is calculated and the map appears showing the entire route, where you can check route information and route alternatives. Tap  to modify the route parameters, or tap  to start your journey.

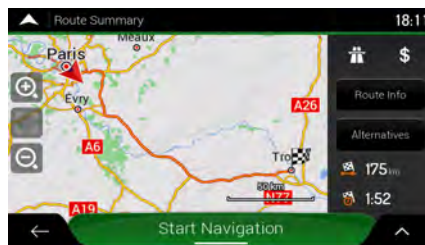

3.1.2.3 Selecting a town centre

The town centre is not the geometric centre of the town but an arbitrary point the map creators have chosen. In towns and villages, it is usually the most important intersection and in larger towns, it is one of the important intersections.

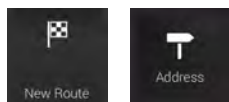

1. Go to  , and modify the country and state as described earlier (page 25), if necessary.
2. If necessary, select a new town by performing the following steps:
 - a. Tap the Town or Postcode field.

- b. (optional) On the Town of Postcode screen, you can select a town from the list of suggestions.

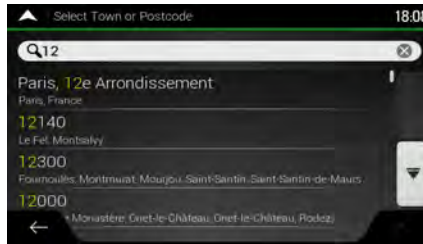

- c. Otherwise, start entering the first few letters of the town. The names that match the string appear in a list.



- d. To open the list, tap  and select the town.

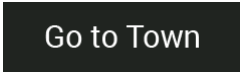
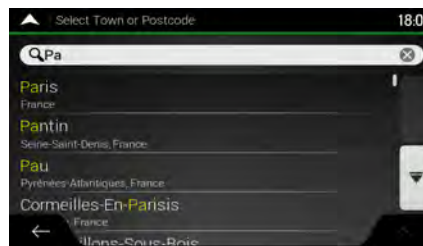

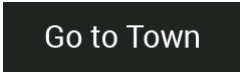
- 3. Tap . This way the centre of the displayed town becomes the destination of the route.

3.1.2.4 Selecting the midpoint of a street

To navigate to the midpoint of a street without entering the house number, perform the following steps:

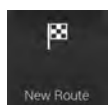
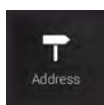

1. Go to , , and select the country and town as described earlier. The Select Street screen appears.
2. Enter the street name by performing the following steps:
 - a. Tap the Street name field.
 - b. (optional) On the Select Street screen, you can immediately select a street from the list of suggestions.

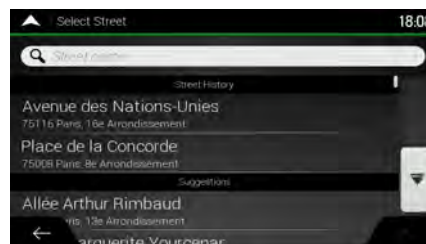

- c. Otherwise, start entering the street name on the keyboard. The names that match the string appear in a list.

- d. Tap  to open the list of results. Select the street from the list.



3. Instead of entering the house number, tap . The midpoint of the street is selected as the destination.

3.1.2.5 Selecting an intersection in a town

To navigate to an intersection, perform the following steps:

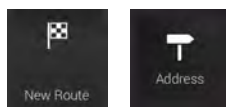

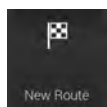
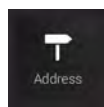
1. Go to , , and select the country and city as described earlier.
2. Enter the street name by performing the following steps:
 - a. Tap the Street name field.
 - b. (optional) On the Select Street screen, you can immediately select a street from the list of suggestions.



- c. Otherwise, start entering the street name on the keyboard. The names that match the string appear in a list.

- d. Tap  to open the list of results. Select the street from the list.

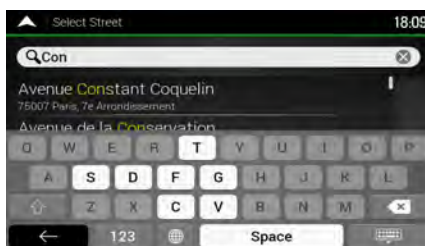

3. Tap the House number or crossing street field and browse the list of crossing streets or start entering the street name in the field. Select one from the list.



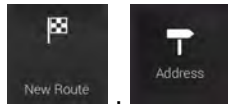

3.1.2.6 Using the postcode to select a destination

You can also select any kind of destination by entering the postal code instead of the city name. To select the postal code, perform the following steps:

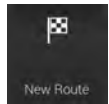
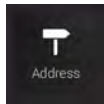

1. Go to  ,  , and modify the country and state as described earlier (page 25), if necessary.
2. Tap the Town or Postcode field.
3. Enter the postcode by performing the following steps:

- a. Tap  to open the numeric keypad.
- b. Start entering the postal code.
- c. Tap  to open the list of results.
- d. Find the place you need.

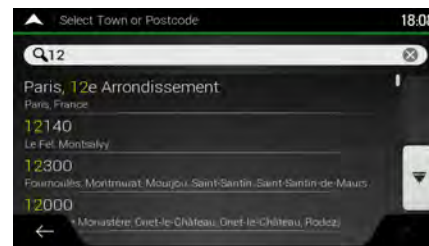
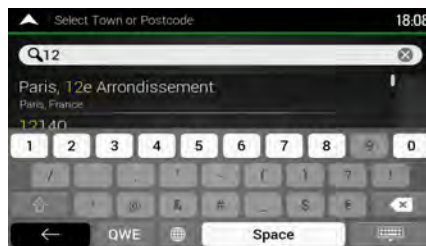

4. Continue the search as described previously (page 25).

3.1.3 Selecting a Place of Interest

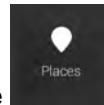

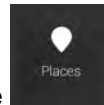
You can search for Places of Interest (Places) in the  menu.

Using the same screen, you can find a Place by selecting one of the following options:

- Finding frequently searched types of Places with the Quick search categories, see page 34
- Searching for a Place by its name, see page 38
- Searching for a Place by its category, see page 36

In case of emergency, you can also find help nearby, see page 39



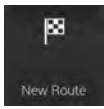
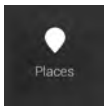

3.1.3.1 Using Quick search categories

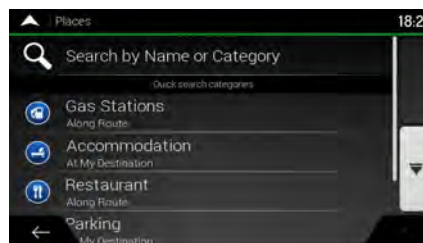
The Quick search feature helps you quickly find the most frequently selected types of Places. Perform the following steps:

1. Tap  on the Navigation view to access the Navigation menu.
2. Tap  and .





The following Quick search categories appear:

-  **Petrol Stations**
Along Route: If a planned route exists, petrol stations are searched along the route.
-  **Accommodation**
At My Destination: If a planned route exists, accommodation is searched around the destination.
-  **Restaurant**
Along Route: If a planned route exists, restaurants are searched along the route.
-  **Parking**
At My Destination: If a planned route exists, parking lots are searched around the destination.



If there is no planned route (destination is not selected), the search is carried out around the current position. If the current position is not available either (no GPS signal), places are searched around the last known position.

3. Tap any of the quick search buttons to get an instant list of Places.



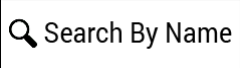



4. The Places in the list can be ordered by their distance from the current or last known position, from the destination, or by the length of the necessary detour. If you need to reorder the list, tap . To filter the list of results by providers, tap  and then the provider logo on the right side of the screen.



5. (optional) If needed, tap  to further filter the list of results.
6. Browse the list and tap one of the list items. A full screen map appears with the selected point in the middle. The name and address of the Place is displayed at the top of the screen.

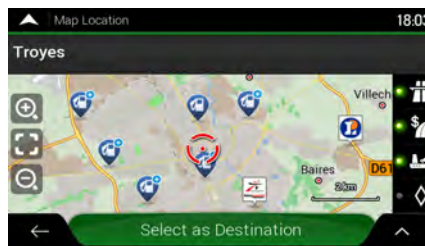

7. Tap  to see the details of the selected Place, or to save the location.
8. If necessary, tap the map somewhere else to modify the destination. The cursor  appears at the new location.

9. Check the settings for road types and change them if necessary.

Tap  to enable or avoid motorways, tap  for roads with Period Charge or Per-use Toll, tap  for ferries, or tap  for carpool lanes.



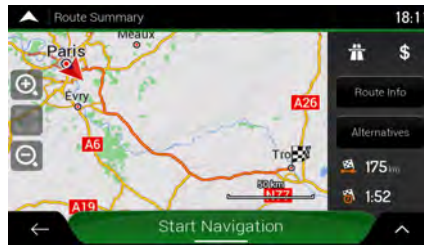

10. Tap  to confirm the destination. You can also select a nearby point on the map or tap  to select a different destination.

- The route is calculated and the map appears showing the entire route, where you can check route information and route alternatives. Tap  to modify the route parameters, or tap  to start your journey.

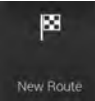
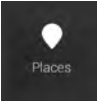
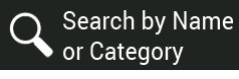
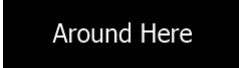

3.1.3.2 Searching by category

To search for Places by their categories and subcategories, perform the following steps:

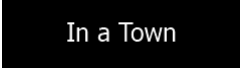
- Tap  on the Navigation view to access the Navigation menu.
- Tap  and .
- Tap .
- Select the area around which you would like to search for the Place by tapping . By default, the search area is around the current position (or if it is not available, around the last known position). In this case, the following result list is ordered by the distance from this position.
 - Tap  to search along the planned route, and not around a given point. This is useful when you search for a later stopover that results in a minimal detour only, such as searching for upcoming petrol stations or restaurants. (The result list is ordered by the length of the necessary detour.)
 - Tap  to search for a place around the destination of the planned route. (The result list is ordered by the distance from the destination.)
 - Tap  to search for a place within a selected town. (The result list is ordered by the distance from the centre of the selected town.)

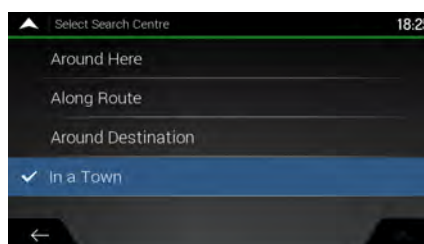

In a Town

5. (optional) If you have selected **In a Town**, select the town to search in.



6. Select one of the main Place categories (for example, Accommodation), then browse the subcategories (for example, Hotel or Motel) to find your destination.



7. You can turn the Category View off at any level to list all Places around the selected location or along the route.

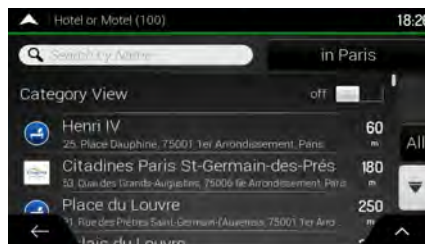

8. (optional) The Places in the list can be ordered by the following criteria:

- Name
- Their distance from the current or last known position
- Their distance from the selected town
- Their distance from the destination
- The length of the necessary detour.



Tap  to reorder the list.

To filter the list of results by providers, tap  and then the provider logo on the right side of the screen.

9. Browse the list and tap one of the list items. A full screen map appears with the selected point in the middle.
10. The process continues the same way as in case of any other search for Places. See page 34.

3.1.3.3 Searching by name

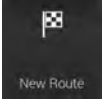
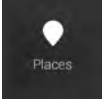
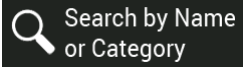
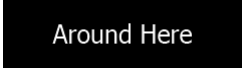
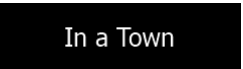
To search for a Place by name, browse the various Place categories, or use the mixture of the two search types, perform the following steps:

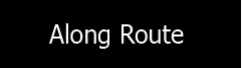
1. Tap  on the Navigation view to access the Navigation menu.
2. Tap  and .
3. Tap  to open the Search By Name or Category window.
4. Select the area around which you would like to search for the Place. By default, the search area is around the current position (or if it is not available, around the last known position). In this case, the result list is ordered by the distance from this position. Tap  to select one of the following search areas:
 - Tap  to search for a place within a selected town. (The result list is ordered by the distance from the centre of the selected town.)
 - Tap  to search for a place around the destination of the planned route. (The result list is ordered by the distance from the destination.)
 - Tap  to search along the planned route, and not around a given position. This is useful when you search for a later stopover that results in a minimal detour only, such as searching for upcoming petrol stations or restaurants. (The result list is ordered by the length of the necessary detour.)

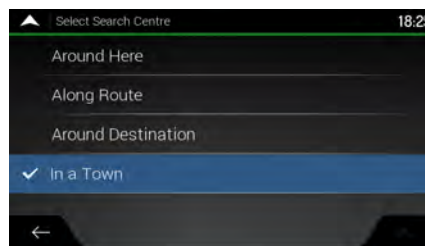

5. (optional) If you have selected , select the town to search in.

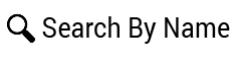

You can search for the name of a Place in all categories by performing the following steps:

1. Tap  Using the keyboard, start entering the name of the Place or browse in the categories.





2. After entering a few letters, tap  to open the list of Places or Place categories with names containing the entered character sequence.



3. Browse the list, if necessary, and tap the desired list item. A full screen map appears with the selected point in the middle. The process continues the same way as in case of any other Places search. See page 34.



3.1.3.4 Finding help nearby

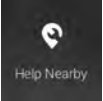

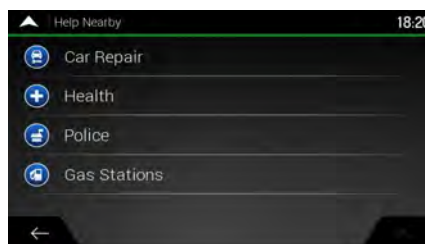
To quickly search for nearby assistance, perform the following steps:

1. Tap  on the Navigation view to access the Navigation menu.
2. Tap  and .



Places in the following pre-set search categories can be searched for around the current position (or around the last known position if the current position is not available):

-  Car Repair: Car repair and roadside assistance services
-  Health: Medical and emergency services

-  : Police stations
-  : Petrol stations

3. Tap any of the quick search buttons to get an instant list of those types of Places.

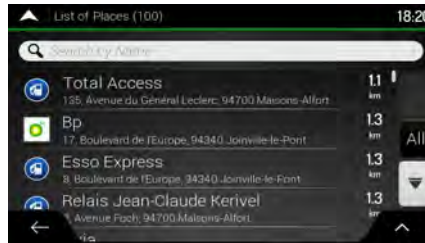

4. (optional) The Places in the list can be ordered by the following criteria:

- By their distance from the current or last known position
- By name.



Tap  to reorder the list.

5. Browse the list and tap one of the list items. A full screen map appears with the selected point in the middle.
6. The process continues the same way as in case of any other Places search. See page 34.

3.1.4 Selecting a Saved Location

To select a location that you have already saved (page 56), perform the following steps:

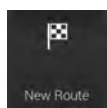
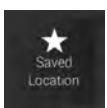
1. Tap  on the Navigation view to access the Navigation menu.
2. Tap  and .
3. The list of saved locations is displayed. It contains two pre-set categories: Home and Work.



4. Tap the location that you want to set as your destination. If necessary, browse the list to see more results.



5. (optional) If needed, tap  to enable the editing option so that you can rename the saved locations or delete any of them.



- After you have selected a saved location as the destination, a full screen map appears with the selected point in the middle.

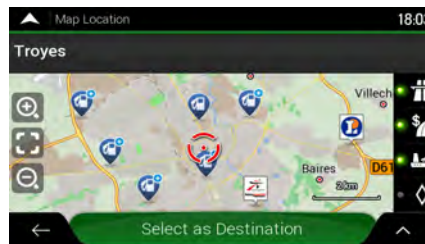

- If necessary, tap the map somewhere else to modify the destination. The cursor () appears in the new location.

- Check the settings for road types and change them if necessary.

Tap  to enable or avoid motorways, tap  for roads with Period Charge or Per-use Toll, tap  for ferries, or tap  for carpool lanes.



- Tap  to confirm the destination. You can also select a nearby point on the map or tap  to select a different destination.

- The route is calculated and the map appears showing the entire route, where you can check route information and route alternatives. Tap  to modify the route parameters, or tap  to start your journey.

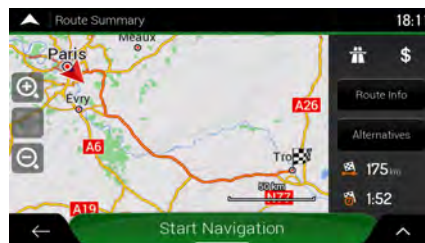

3.1.5 Selecting a History item

The destinations that you have used earlier appear in the History list. Smart History offers these locations from your previous destinations, using parameters like the current time of day, the day of week, and the current location. The more you use the navigation software, the better it can guess your desired destination. To select a History item, perform the following steps:

- Tap  on the Navigation view to access the Navigation menu.

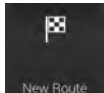

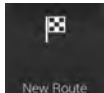
2. Tap . Two of the Smart History Items are displayed in the New Route to... screen for easy access. You can select one of them as your destination.

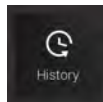
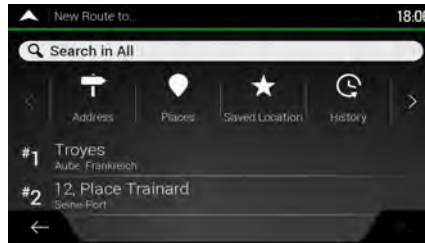

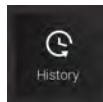

3. To open all the history items, tap . The list of recent destinations appears. The list begins with the three most likely destinations that are selected based on your previous routes (Smart History). The rest of the destinations are ordered by the time they were last selected. If necessary, scroll the list to see earlier destinations.
4. Select a destination from the list.
5. A full screen map appears with the selected point in the middle. If necessary, tap the



map somewhere else to modify the destination. The cursor () appears at the new location.

6. Check the settings for road types and change them if necessary.





Tap  to enable or avoid motorways, tap 



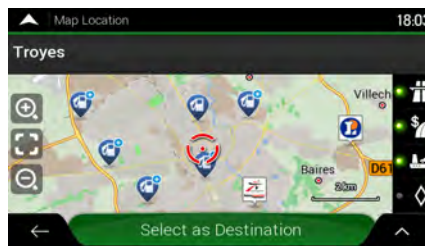

for roads with Period Charge or Per-use Toll, tap  for ferries, or tap 



7. Tap  to confirm the destination. You can also select a nearby point on the map or tap  to select a different destination.



- The route is calculated and the map appears showing the entire route, where you can check route information and route alternatives. Tap  to modify the route parameters, or tap  to start your journey.

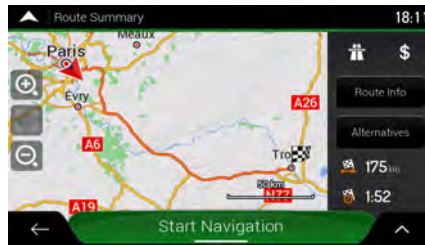

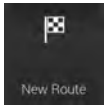
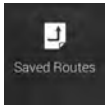

3.1.6 Selecting a saved route

The routes that you have saved earlier appear in a list. To select a previous route, perform the following steps:

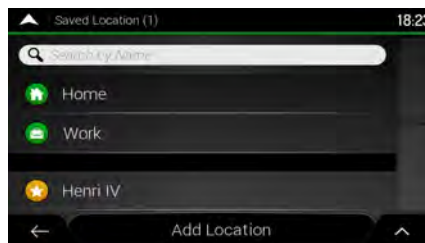
- Tap  on the Navigation view to access the Navigation menu.
- Tap  and .

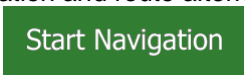

- The list of saved routes appears. If necessary, scroll the list to see earlier routes.
- Select a route and the Multipoint Route screen appears. If necessary, modify the saved route. Otherwise, tap .
- The route is calculated and the map appears showing the entire route, where you can check route information and route alternatives. Tap  to modify the route parameters, or tap  to start your journey.

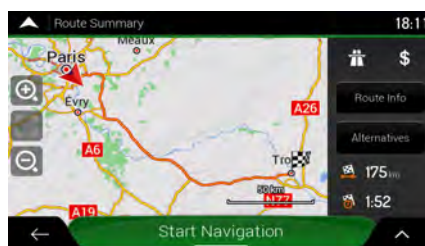

3.1.7 Entering coordinates

To select a destination by entering its coordinates, perform the following steps:

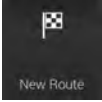
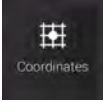
1. Tap  on the Navigation view to access the Navigation menu.
2. Tap  and .
3. You can enter the latitude and longitude values in any of the following formats: decimal degrees, degrees and decimal minutes, or degrees, minutes and decimal seconds.

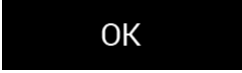
Tap .







(optional) If necessary, tap  then  and enter the coordinate in UTM format.



 Tip!

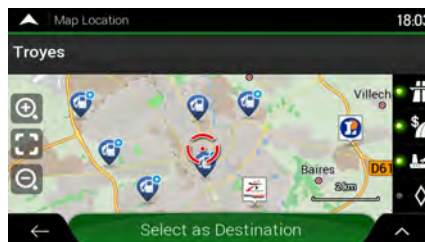

4. A full screen map appears with the selected point in the middle. If necessary, tap the map somewhere else to modify the destination. The cursor () appears at the new location.
5. Check the settings for road types and change them if necessary.

Tap  to enable or avoid motorways, tap  for roads with Period Charge or Per-use Toll, tap  for ferries, or tap  for carpool lanes.



6. Tap **Select as Destination** to confirm the destination. You can also select a nearby point on the map or tap  to select a different destination.
7. The route is calculated and the map appears showing the entire route, where you can check route information and route alternatives. Tap  to modify the route parameters, or tap **Start Navigation** to start your journey.

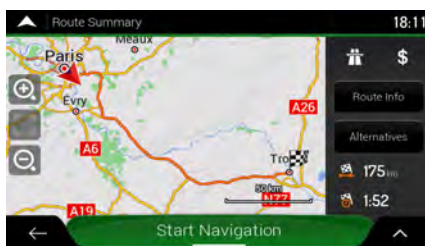



3.1.8 Selecting a location on the map

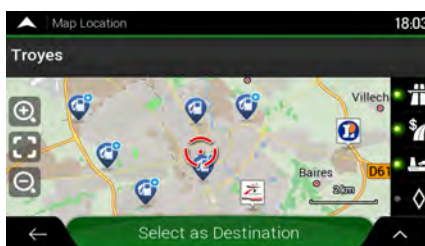

To select a map location, perform the following steps:

1. Locate your destination on the map. Move and scale the map as necessary.





2. Tap the location that you want to select as your destination. The cursor () appears there.

3. (optional) If needed, tap  to list the Places near the selected point or to save this location.

 **Tip!** If you already have a planned route, tap  and **Select as Waypoint** to add the selected location to your route.

4. Tap **Select as Destination** to select the cursor as the destination.

- The route is calculated and the map appears showing the entire route, where you can check route information and route alternatives. Tap  to modify the route parameters, or tap  to start your journey.

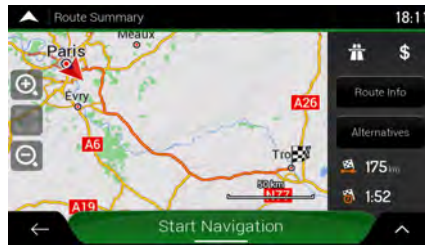

3.1.9 Planning a Multipoint Route

To build your route destination-by-destination, perform the following steps:

- Tap  on the Navigation view to access the Navigation menu.

- Tap  .



- There is only one line in the list of route points, the starting point of the route, which is normally the current GPS position.

- Tap  to select the destination.

- The New Route to... screen appears, where you can select the destination of the route the same way as described in the previous sections.

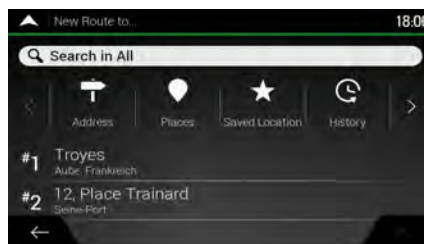

- When the selected location appears on the map, tap **Select as Destination** and the list returns. If needed, you can add further intermediate destinations.



- To add more route points, tap **Insert Waypoint +** or tap **Final Destination +** to change the final destination. The Add to Route... menu appears again, where you can select the new route point the same way as you have set the destination before.

- (optional) Tap  to optimise the whole route or the order of waypoints. You can also delete all the destinations.

- When you have added all the route points, tap **Calculate Route** and the planned route is automatically calculated.

3.2 Checking Route Information and Alternatives

To get a map overview of the planned route and check different parameters of the planned route, perform the following steps:

- Tap  on the Navigation view to access the Navigation menu.

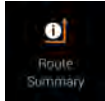
- In the Navigation menu, tap .

- The planned route is displayed in its full length on the map with the following additional information:

- The total length of route
- The total time of route.

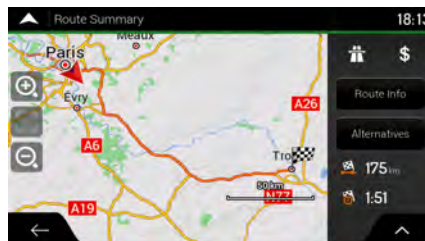

4. You have the following options on this screen:

- Tap **Route Info** to receive detailed information about the route.



If you tap **All** on the right side of the screen, you can narrow the route information, for example to show only motorway sections or toll roads.

- Tap **Alternatives** to list route alternatives and select the most suitable route for you.



Tap **Up Arrow** on the Route Summary screen to carry out additional actions, for example edit your route preferences or display the itinerary.

3.3 Checking Traffic Events

Offline statistical traffic information (historical speed information or traffic patterns) can be taken into account in the route calculation based on the time of day and the day of week if suitable data can be found on the device. In addition, real-time traffic information can help you avoid current traffic events like temporary road closures or traffic jams caused by an accident. Both functions are subject to data availability.

For information on traffic icons, see page 19.

Road segments affected by traffic events are displayed in a different colour on the map, and small symbols above the road show the nature of the event.

To check the traffic summary, perform the following steps:

- On the Navigation view, tap the traffic icon in the corner (for example, ) to open the Traffic Summary screen, or tap  and  .



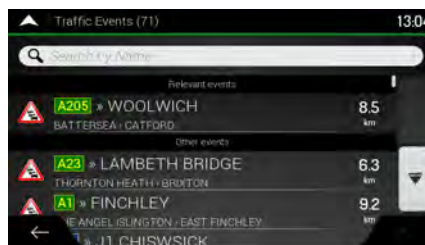

- If there is at least one significant event on the planned route, a description is displayed about the next event. Tap  to see the list of all events.

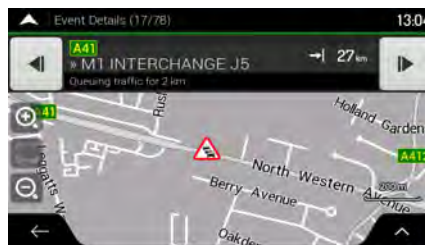

- Tap any of the list items to see its details and to display the affected road segment in its full length on the map.



To display real-time traffic information on the map, perform the following steps:

- On the Navigation view, tap the traffic icon (for example, ) to open the Traffic summary screen and tap  .

- Tap  to display real-time traffic information on the map. A 2D map is displayed with road segments coloured by the impact on the traffic flow.

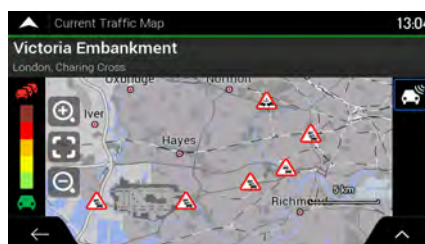

3.4 Editing the route

When navigation has already started, there are several ways to modify the planned route. You have the following options:

- Setting a new starting point, see page 50
- Adding an additional destination, see page 51
- Modifying the list of destinations, see page 52
- Saving the planned route, see page 52
- Deleting the planned route, see page 53
- Selecting a route alternative when planning the route, see page 54
- Selecting a route alternative for an existing route, see page 55
- Pausing guidance, see page 56.



3.4.1 Setting a new starting point

For normal navigation, all routes are calculated from the current position. You can pause navigation to check future routes, simulate them or see their length in time and distance. Then you can set the starting point of the route to a location other than the current GPS position.

1. Tap  on the Navigation view to access the Navigation menu.

2. In the Navigation menu, tap  .



3. The first line from the bottom is the start of the route, normally the current GPS position. Tap , select , and confirm your action at the warning message.

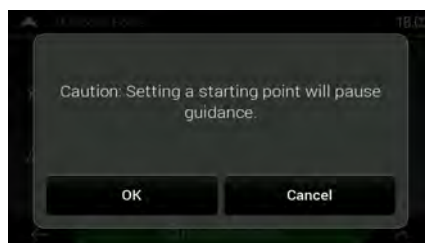

- The Change Start to... screen appears. Select the starting point of the route the same way you select a destination.

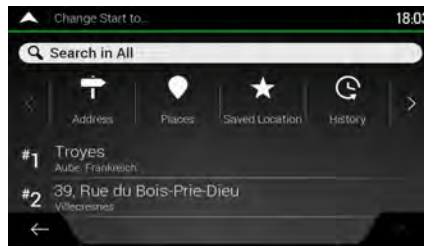

- You can see the new starting point on the map. Tap **Set Start Point** and the Multipoint Route screen appears where you can continue adding a destination to your route.

- Tap **Calculate Route** to continue. The map returns with a transparent position marker (showing that there is no GPS reception). If a planned route already exists, it is now recalculated starting from the selected location.





- To return to normal navigation, tap **Continue Guidance**.

3.4.2 Adding an additional destination

If you already have a planned route and you select a new destination as described in the above sections, the route to the previous destination is deleted and a new route is calculated.

To add a new intermediate destination to the planned route, perform one of the following actions:

- Tap the map anywhere to browse it. After selecting the location on the map, tap  and **Select as Waypoint** to add the selected location to your route as an intermediate destination. The other destinations of the route remain intact.

- Tap  on the Navigation view and tap . Add a destination to your route as described on page 46.

3.4.3 Modifying the list of destinations

To edit your route, perform the following steps:

1. Tap  on the Navigation view to access the Navigation menu.

2. In the Navigation menu, tap  .



You have the following options on this screen:

- Tap  to delete all the destinations, or optimise the waypoints or the route.
- Tap the name of the intermediate destination to move it up or down in the list, to save the location, or to delete it from the list.
- If you have a route with at least one intermediate destination, you can delete the

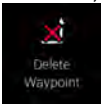
waypoint from the list right from the Main menu. Tap  , then confirm the deletion.

3.4.4 Saving the planned route

To save the planned route, perform the following steps:

1. Select a destination as described earlier and tap  .

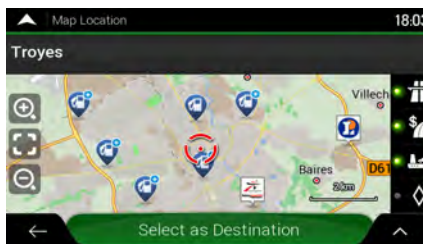

2. Tap  and  .

3. Type in a name and tap



4. The route is saved and it is available in

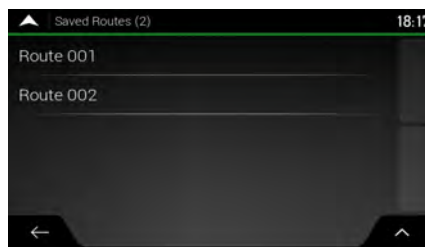
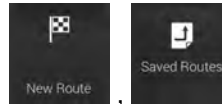

By selecting a previously saved route, NX405E recalculates the route using the saved destination and/or the waypoints.

3.4.5 Deleting the planned route

You have the following two options to delete the navigated route:

- If you already have a planned route and you select a new destination as described in the above sections, the route to the previous destination is automatically deleted and a new route is calculated.

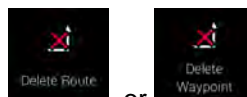

- In the Navigation menu, tap **Delete Route** or **Delete Waypoint**. If there are no waypoints, the planned route is deleted after a confirmation. If you have waypoints, you can choose to delete the whole route, or only the next waypoint.

3.4.6 Selecting a route alternative when planning the route

To select from different route alternatives or change the route planning method after you have selected a new destination, perform the following steps:

1. Select a destination as explained earlier, and go to the route confirmation screen.

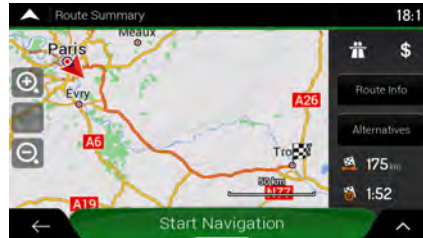

2. Tap **Alternatives**.
3. You can see the basic details of route alternatives. Tap any of them to see it on the map.

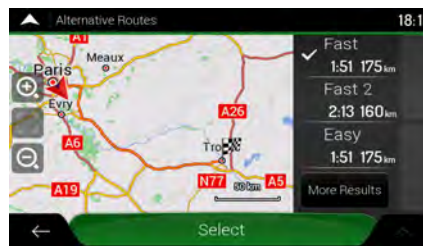

4. To view more suggestions, tap **More Results** and scroll down for other alternative routes with different route planning methods.

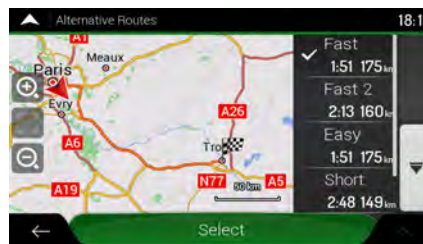

5. Select one of the route alternatives and tap **Select** to return to the previous screen. NX405E recalculates the route. Tap **Start Navigation** to start your journey. The orange line now shows the new planned route.

3.4.7 Selecting a route alternative for an existing route

To recalculate the planned route with a different route planning method and to compare different route alternatives, perform the following steps:

1. Tap  on the Navigation view to access the Navigation menu.
2. You can access the list of route alternatives from the Navigation menu in one of the following ways:

- Tap  and .
- Tap  and .

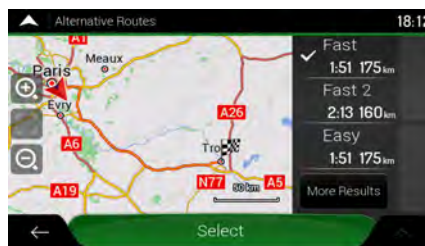

3. You can see the basic details of a few route alternatives. Tap any of them to see it on the map.

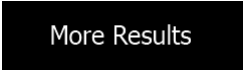

If there are suitable alternatives calculated with the route planning method that is selected in Route preferences (page 71), they are shown on top of the list. Routes with other route planning methods are shown at the bottom of the list.

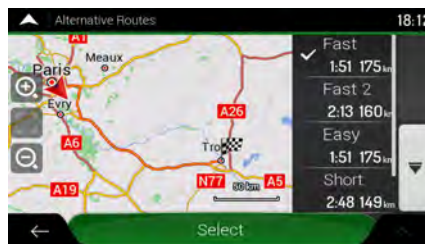
4. If there are more than a few suggestions, you can tap  and scroll down for routes.





5. Select one of the route alternatives and tap  to return to the previous screen. NX405E replaces the original route. Tap  to start your journey. The orange line now shows the new planned route.

3.4.8 Pausing guidance

When you are driving a planned route but you do not need guidance for a certain part of the route, you can suspend it and continue when it is needed again.

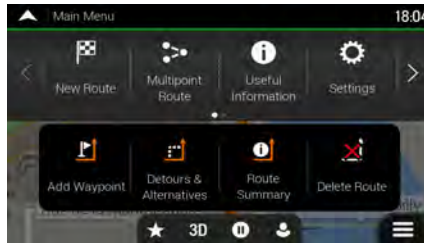
In the Navigation menu, tap  to suspend guidance.





Tap  to resume guidance.

3.5 Saving a location

To add any location to the saved locations (the list of frequently used destinations), perform the following steps:

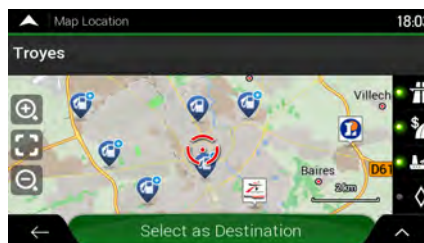
1. Select a destination as described before. It can be an address, a Place, any location on the map, a previously used destination from History, and so on.
2. When the map appears with the selected location in the middle, tap .



3. Tap .
4. (optional) Using the keyboard, you can change the name offered for the Saved Location.

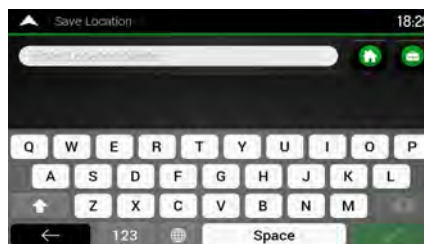

5. Tap  to save the location.

To add your home and work address to the saved locations, perform the following steps:

1. On the Navigation view, tap , , and  .
2. Tap  or  . Tap  to confirm your selection.
3. You can search for the address as described on page 22.

Planning a route to one of the saved locations is described on page 40.

3.5.1 Editing a saved location

To edit a location that you have already added as a Saved Location, perform the following steps:

1. On the Navigation view, tap , , and  .
2. The list of Saved locations is displayed.

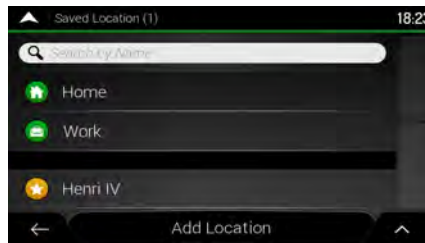

3. Tap  and  .
4. Tap the location you want to edit, tap  and enter the name of the location on the keyboard, then tap  .

In Saved Locations, Home and Work cannot be renamed. To change your home

 Note!

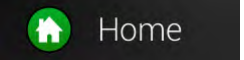
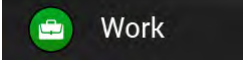
or work location, tap  or  , and confirm the address change.

5. Tap  .

Adding a location to the list of saved locations is described on page 56.

3.6 Adding an Alert Point

You can save any map location as an Alert Point, for example a speed camera or a school zone.

1. If you would like to save an Alert Point for the first time, switch on the

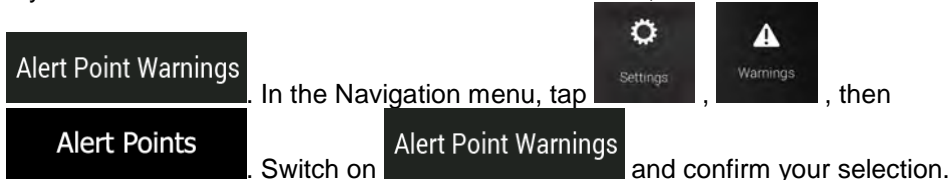

 **Note!** The warning for road safety cameras is disabled when you are in a country where road safety camera warning is prohibited. However, you must make sure that using this feature is legal in the country where you intend to use it.

1. Return to the Navigation view, and select the Alert Point. The red cursor () appears there.

2. Tap .

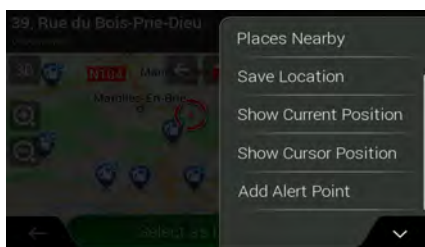

Add alert points

3. Scroll down the list and tap **Add alert points**.
4. Select the type of the Alert Point, the direction from which you expect the alert, and (if applicable) the speed limit for this Alert Point.

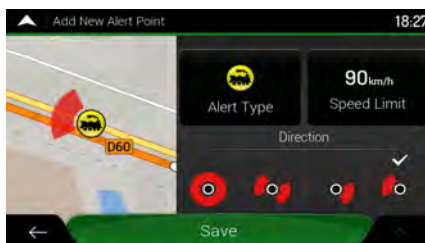

5. Tap  to save the location as a new Alert Point.

3.7 Running a Simulation

To run a simulated navigation that demonstrates the planned route, perform the following steps:

1. Tap  on the Navigation view to access the Navigation menu.

2. In the Navigation menu, tap  .

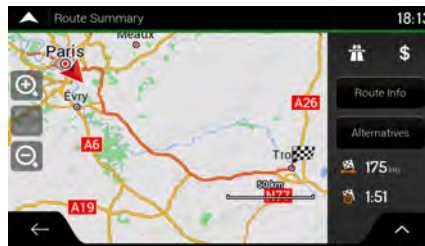



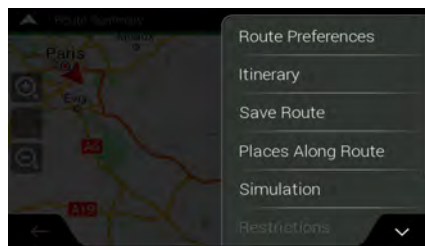

3. Tap .



4. Tap . The simulation starts from the starting point of the route and leads you through the whole planned route using a realistic speed.



(optional) You have the following controls during the simulation (the control buttons disappear after a few seconds but you can open them again if you tap the map):

-  : Jump to the next route event (manoeuvre).
-  : Pause the simulation.
-  : Jump to the previous route event (manoeuvre).
-  : Tap to increase the speed of the simulation to 4, 8 or 16 times faster. Tap again to return to normal speed.



5. Tap  to stop the simulation.

3.8 Off-road navigation

When first started, NX405E calculates routes using the road network of the maps provided with the product. If you want to disregard roads during navigation, you can switch to off-road mode, for example when driving in a desert.

3.8.1 Switching to off-road navigation

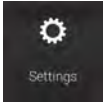
To switch to off-road navigation, perform the following steps:

1. On the Navigation view, tap , , and  .
2. Tap  and select  .

Most of the procedures described for on-road navigation also apply to off-road navigation. However, there are some that are not available in this navigation mode. For example:

- You cannot open the itinerary as you have no manoeuvres just route points and straight lines between them.
- There are no route alternatives and route planning method.
- Vehicle settings are disabled.

3.8.2 Selecting the destination in off-road mode

Selecting a destination (waypoint or final destination) is the same as described in the previous sections. The only difference is that route points are linked to form a route with straight lines regardless of the road network and traffic regulations.

3.8.3 Navigating in off-road mode

The real difference between on-road and off-road modes is the navigation itself. When you are on the Navigation view with an off-road route:

- Your position and heading is not aligned to the nearest road.
- There is no turn-by-turn navigation, just a recommended direction.

You can see an orange line drawn between your current position and the next destination to reach. The Turn Preview field in the top left corner shows a compass with your bearing and the distance of the next destination.

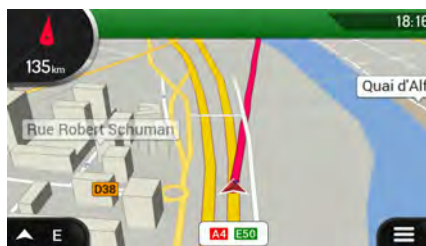

When you reach the final destination, the navigation ends.

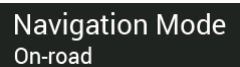
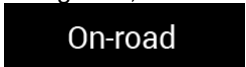

If you do not want to use off-road navigation, switch back to on-road navigation by tapping  and .

4 Reference guide

The following sections describe the different concepts and menu screens of NX405E.

4.1 Concepts

The following sections describe and explain navigation-related concepts.

4.1.1 2D/3D GPS reception

The GPS receiver uses satellite signals to calculate its (your) position and needs at least four signals to give a three-dimensional position, including elevation. Because the satellites are moving and because objects can block the signals, your GPS device might not receive four signals. If three satellites are available, the receiver can calculate the horizontal GPS position but the accuracy is lower and the GPS device does not give you elevation data; only 2D reception is possible.

Several factors have an impact on the deviation between your real position and the one given by the GPS device. For example, signal delay in the ionosphere or reflecting objects near the GPS device have a different and varying impact on how accurately the GPS device can calculate your position.

4.1.2 Natural and TTS voices

Natural voices are the traditional type of voice instructions. Every phrase that occurs in voice guidance messages is recorded in a studio with a real person. The advantage of pre-recorded voice is that it sounds really natural, but the range of instructions that can be given this way is limited. Location-specific information such as street names cannot be announced.

TTS technology provides a machine-generated way to give voice instructions. The advantage of TTS is that it can announce street names, traffic events, route summary, and traffic rules.

4.1.3 Road safety cameras and other proximity Alert Points

There is a special proximity warning for road safety cameras (like speed or red light cameras) and other proximity Alert Points (like schools or railroad crossings). These Alert Points are not part of NX405E. You can download Alert points from clarion.naviextras.com or you can upload points in a specific text file if needed.

You can add your own Alert Points. See page 58.

The application can warn you when you approach road safety cameras like speed cameras or dangerous areas like school zones or railroad crossings. You can set up the different alert types individually in the Warnings settings, see page 75.

The following warning types are available:

- Audio warning: beeps are played (if the voice guidance language that you selected is a natural voice) or the type of the alert can be announced (TTS voice) while you are approaching one of these points, and an extra alert warns you if you exceed the given speed limit while approaching.

- Visual warning: the type of the Alert Point, its distance and the related speed limit appear on the Navigation view while you are approaching one of these locations.

For some of the Alert Points, either the enforced or expected speed limit is available. For these points, the audio alert can be different if you are below or above the given speed limit.

- Only when speeding: The audio alert is only played when you exceed the given speed limit.
- When approaching: The audio alert is always played when approaching one of these Alert Points. In order to draw your attention, the alert is different when you exceed the speed limit.



Note!

The warning for road safety cameras is usually disabled when you are in a country where road safety camera warnings are prohibited. Make sure that using this feature is legal in the country where you intend to operate. Use it on your own responsibility.

4.1.4 Route calculation and recalculation

A route is a sequence of route events, that is, manoeuvres (for example, turns and roundabouts) to reach the destination. The route contains one starting point and one or more destinations. The starting point is the current (or last known) position by default. If you need to see a future route, the starting point can be replaced with any other given point. See page 50.

Once the destination has been selected, NX405E calculates the route based on your preferences. These preferences are the route planning method and the road types used or avoided when calculating the route. For detailed information on all the preferences, see Route preferences settings. See page 71.

Real-time traffic events are also taken into account, which sometimes greatly modify the route. See page 64.

NX405E automatically recalculates the route if you deviate from the proposed itinerary.

If traffic services are enabled, NX405E considers real-time dynamic traffic information in route calculation and may also recalculate the route if the traffic situation changes during navigation.

4.1.5 Smart Zoom

Smart Zoom provides the following features:

- **While following a route:** When approaching a turn, it zooms in and raises the view angle to let you easily recognise your next manoeuvre. If the next turn is at a distance, it zooms out and lowers the view angle to be flat so you can see the road in front of you.
- **While driving without a planned route:** Smart Zoom zooms in if you drive slowly and zooms out when you drive at a high speed.

4.1.6 Speed limit warning

Maps may contain information about the speed limits of the road segments. NX405E is able to warn you if you exceed the current limit. This information may not be available for your region, or may not be fully correct for all roads on the map.

The maximum speed set in the vehicle profile (page 71) is also used for this warning. NX405E alerts you if you exceed the pre-set value even if the legal speed limit is higher.

Speed warning can be fine-tuned in Warnings. See page 75.

You can also set the relative speed tolerance above which the application initiates the warning.

The following warning types are available:

- Audio warning: You receive a verbal warning when you exceed the speed limit with the given percentage.
- Visual warning: The current speed limit is shown on the map when you exceed it (for example ).

You can also choose to see the speed limit sign on the map all the time.

4.1.7 Real-time traffic

Real-time traffic information can provide you with the current status of the traffic. Route calculation can avoid road blocks or unexpected traffic jams caused by an accident.

The following data sources are available:

- Traffic Message Channel (TMC):
TMC is a specific application of the FM Radio Data System (RDS) used for broadcasting real-time traffic and weather information.
If public Traffic data is broadcast at your location, NX405E automatically searches the FM radio stations for TMC data, and the decoded information is immediately used in route planning.

 Note! TMC is not a global service. It may not be available in your country or region. Ask your local dealer for coverage details.



The application automatically takes account of the traffic events received. You do not need to set anything in NX405E.

When NX405E receives traffic information that may affect your route, it warns you that it is recalculating the route. The navigation continues with a new optimal route considering the most up-to-date traffic conditions.

For information on traffic icons, see page 19.

To fine-tune this service, you have the following options in Traffic settings (page 79):

- Set the minimum amount of time that you think is worth saving at the cost of a detour.
- Instruct NX405E to have you confirm the new planned route before it takes effect.

 Note! If there are traffic events on the planned route that the application has not bypassed, the  icon opens the list of significant traffic events to let you quickly check them.

4.1.8 Intelligent navigation

With the help of intelligent navigation, the planned route can adapt to traffic and other changes during navigation. The following sections describe these features.

4.1.8.1 Congestion detour on highways

NX405E may offer a detour when you slow down on a highway due to a traffic jam. The Potential congestion detour window appears and shows the length and duration of the detour.

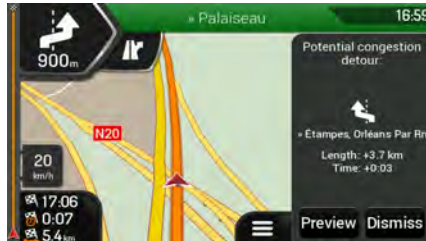

You can ignore this message and keep the original route by tapping

Dismiss

or

you can check the suggested route by tapping

Preview

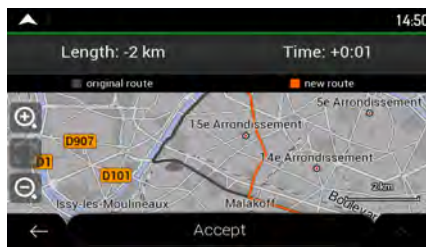

By tapping the plus/minus signs, you can increase or decrease the distance to avoid on the highway.

Avoid

You can accept the recommended detour by tapping

4.1.8.2 Real-time alternative routes

NX405E may offer an alternative route on normal roads in case of a traffic jam. The possible alternative route window appears and shows the length and duration of the detour.

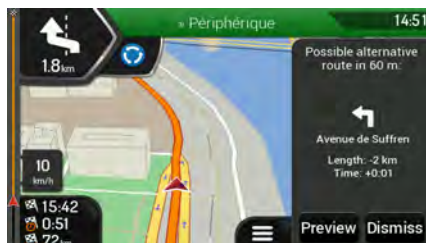

You can ignore this message and keep the original route by tapping **Dismiss** or you can check the suggested route by tapping **Preview**. You can accept the recommended detour by tapping **Accept**.

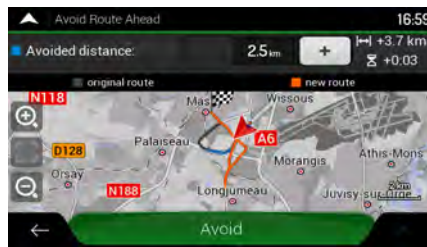

4.1.8.3 Parking around destination

If you leave the planned route by exiting a motorway, NX405E tries to guess the reason for making a detour. By tapping **P**, you can open a top-down map with the recommended parking Places around the destination. By tapping the arrows on the sides, you can switch between the recommended parking facilities.

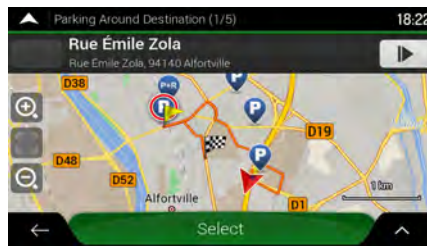

By tapping **Select** and **Park Here**, the selected parking place becomes your destination.

4.1.8.4 Hints upon detour

If you leave the planned route by exiting a motorway, NX405E tries to guess the reason for making a detour. The Reason for detour window appears and shows available petrol stations, restaurants or other Places around the current position. Also, if there are avoidable parts of the original route ahead (like a tunnel, a toll road or a ferry), you can find them in the list, in case you want to bypass them.

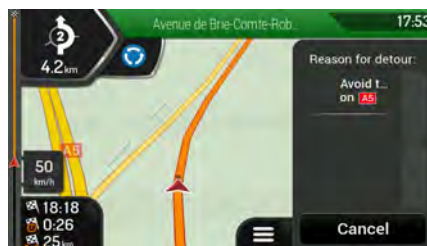





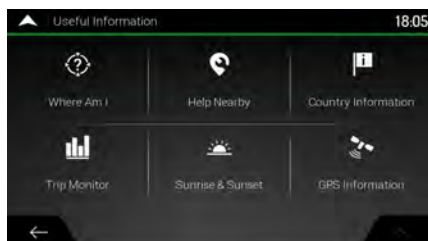

By tapping one of the Places, NX405E creates a waypoint and navigates you to the selected place. You can ignore them by tapping .

4.2 Useful Information menu



The Useful Information menu provides various additional functions. It can be found in the Navigation menu. You need an Internet connection via your mobile phone to access online services, like parking and weather information.

| Button | Description |
|---|--|
|  | Shows information on the current position (latitude, longitude, nearest town, next crossing street, and so on) or the last known position if GPS reception is not available. See page 68. |
|  | Offers assistance near your current position. See page 39. |
|  | Offers a list of countries with useful driving information about the selected country (for example speed limits, maximum blood alcohol level). |
|  | Shows statistical data of your trips, like the start time, end time and average speed, see page 69. Track logs, the sequence of the positions given by the GPS receiver, can be saved together with the trip logs. They can later be displayed on the map. |
|  | Shows a world map with the sunlit and dark areas of the world. Tap  to check the exact sunrise and sunset times for all your route points. |
|  | Shows the GPS Information screen with satellite position and signal strength information. |

4.2.1 Where Am I

This screen contains information about the current position (or about the last known position if GPS reception is not available). You can access it the following two ways:

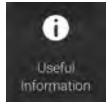
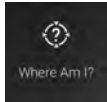
- By going to the Navigation menu and tapping  and .

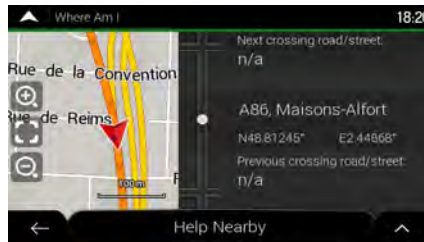

- By tapping the current street name if it is displayed below the current position marker on the map.

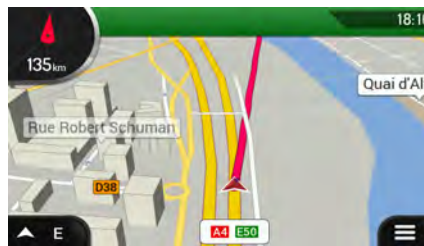

The following information is shown on the Where Am I screen:

- Address details (when available) of the current position
- Latitude and Longitude (coordinate of the current position in WGS84 format)
- The nearest town
- Next crossing road/street
- Previous crossing road/street.

You can also perform some actions on this screen.

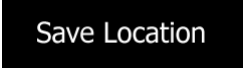
Tap  and  to add the current position to the saved locations and to check the country information.

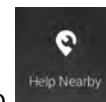

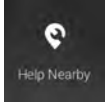

You can also search for assistance near your current position. Tap  to open a new screen for quick search and select a category. For detailed information, see page 39.

4.2.2 Trip Monitor

Trip Monitor logs information about your route.

You can record a new trip by tapping **Start New Recording** and stop it by tapping **Stop Recording**.

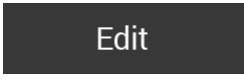
By tapping  on the Trip Monitor screen, you can select the following options:

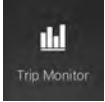
| Button | Function |
|---|--|
|  | By selecting a recorded trip, you can delete, rename, or change the colour of the recorded route. |
|  | You can export all logs into the sdmmc folder. |
|  | You can access the Trip Monitor Settings, where you can enable saving the trip logs automatically or you can save the trip logs manually. See page 80. |

By tapping your recorded trip on the Trip Monitor screen, you can check information such as time, speed, altitude and distance.



By tapping  on the Trip Data Details screen, you can view the trip on the map, export track logs, and check the elevation and speed profiles.

4.3 Settings menu

You can configure the navigation settings, and modify the behaviour of NX405E, by tapping

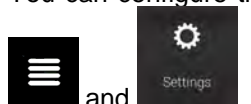





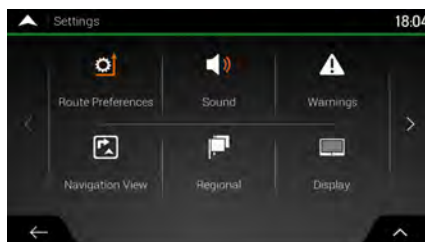

and

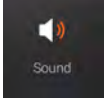
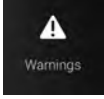
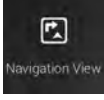
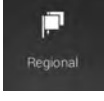
Tap the arrows to view the content of other pages.

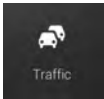
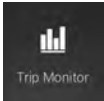

The Settings menu provides the following options:

| Button | Function |
|---|--|
|  | Select the road types used in route planning, and the route planning method. |
|  | Adjust the different sound volumes. |
|  | Enable and set up warnings for speed limit, Alert Points (such as speed cameras), and road signs. |
|  | Fine-tune the appearance of the Navigation view or adjust how the software helps you navigate with different kinds of route-related information on the Navigation view. |
|  | Change the voice guidance language, set the time zone, the measurement units, the time and date, and formats, and customise the application for your local language. |
|  | Enable or disable menu animations. |
|  | Enable or disable traffic information and modify detour settings. |
|  | Turn the automatic trip log saving on or off and check the current size of the trip database. |
|  | Collects usage information and GPS logs that may be used for improving the application and the quality and coverage of maps. Tap this button to enable or disable collecting these data. |

| | |
|---|---|
|  | Modify the basic software parameters set during the initial set-up process. See page 6. |
|  | These settings determine how user data is managed. There are three options: <ul style="list-style-type: none"> • Backup User Data: All user data and the current settings are saved on the inserted microSD card, and each backup is stored in a new file. • Restore User Data: All user data and the settings are overwritten with the information stored in the latest backup file. • Delete User Data: All the user backup files are deleted. |

4.3.1 Route preferences settings

The following settings determine how routes are calculated:

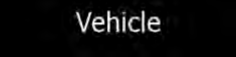
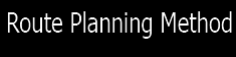
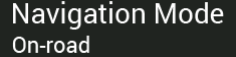
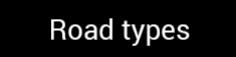
| Button | Function |
|---|---|
|  | Edit the parameters of the vehicle profile. See page 71. |
|  | Optimise the route calculation for different situations and vehicle types by changing the planning method. See page 72. |
|  | Select on-road or off-road navigation. See page 60. |
|  | Select your preferred road types for the route. See page 73. |



4.3.1.1 Vehicle profile

You can select the following vehicle types:

| Button | Description |
|---|--|
|  Car | Manoeuvre restrictions and directional constraints are taken into account when planning a route. Roads are used only if access for cars is allowed. Private roads and resident-only roads are used only if they are inevitable to reach the destination. Walkways are excluded from routes. |

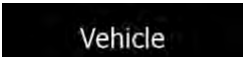

Creating a profile makes it possible to set up vehicle parameters used in route planning. You can have several profiles for the same vehicle.

To add a new vehicle profile, perform the following steps:

1. Tap , browse the list of vehicles, and tap .
2. Select the vehicle type and set the parameters below.

You can set the following parameters:

| Button | Function |
|------------------------|--|
| Name | Rename the profile for something meaningful, for example John's car. |
| Max. Speed | Set the maximum speed you travel at. |
| Fuel Consumption Urban | Enter the average consumption of your vehicle in built-up areas. The unit for consumption can be set in Regional Settings. |
| Fuel Consumption Rural | Enter the average consumption of your vehicle on highways. The unit for consumption can be set in Regional Settings. |
| Engine Type | Select the engine and fuel type of your vehicle. It helps estimate the CO ₂ emission. |

To reset all vehicle profiles to their default settings, tap , , and



4.3.1.2 Route Planning Method types

You can select from the following route planning method types:

| Button | Description |
|--------|---|
| Fast | Gives a quick route if you can travel at or near the speed limit on all roads. Usually, the best selection for fast and normal cars. |
| Easy | Results in a route with fewer turns and no difficult manoeuvres. With this option, you can make NX405E take, for example, the motorway instead of a series of smaller roads or streets. |
| Short | Gives a short route to minimise the travel distance. It can be optimal for slow vehicles. Searching for a short route regardless of the speed, this route type is rarely optimal for normal vehicles. |
| Green | Gives a quick but fuel-efficient route based on the fuel consumption data. Travel cost and CO ₂ emission calculations are estimations only. They cannot take elevations, curves and traffic conditions into consideration. |

4.3.1.3 Navigation Mode

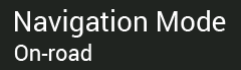
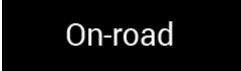
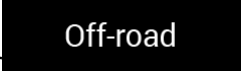





You can switch between on-road and off-road navigation by tapping  and selecting  or  (page 60).

4.3.1.4 Road types

To let the route fit your needs, you can also set which road types are to be considered for or to be excluded from the route.

Excluding a road type is a preference. It does not necessarily mean total prohibition. If your destination can only be accessed using some of the excluded road types, they are used only as much as necessary. In this case, a warning icon is shown on the Route information screen, and the part of the route not matching your preference is displayed in a different colour on the map.

The following road types are available:

| Button | Description |
|--|--|
|  Motorways | You might need to avoid motorways when you are driving a slow car or you are towing another vehicle. |
|  Period Charge | Charge roads are pay roads where you can purchase a pass or vignette to use the road for a longer period of time. They can be enabled or disabled separately from toll roads. |
|  Per-use Toll | Per-use toll roads are pay roads where there is a per-use charge in the routes by default. If you disable toll roads, NX405E plans the best toll-free route. |
|  Ferries | NX405E includes ferries in a planned route by default. However, a map does not necessarily contain information about the accessibility of temporary ferries. You might also need to pay a fare on ferries. |
|  Car Shuttle Trains | Car shuttle trains are used to transport vehicles for a relatively short distance and they usually connect places that are not easily accessible on a road, for example, in Switzerland. |
|  Carpool Lanes | Carpool or HOV lanes can be used if a given number of passengers is travelling in the vehicle. Check whether you are allowed to use carpool lanes before enabling this road type. |
|  Unpaved Roads | NX405E excludes unpaved roads by default. Unpaved roads can be in a bad condition and you usually cannot reach the speed limit on them. |

4.3.2 Sound settings

You can modify the following settings:

| Button | Function |
|--------|---|
| Voice | Adjust the volume of the guidance sounds (verbal instructions) or mute it. |
| Alerts | Adjust the volume of the non-verbal alert sounds (beeps) or mute it. |
| Ding | Turn off the attention tone preceding verbal instructions or adjust its volume. |
| Keys | Adjust the volume or mute the sound played when pressing the button. |

You have the following options for each sound type:

| Button | Function |
|---|---|
| Volume slider | Adjust the volume of the related sound. |
|  | Mute the related sound. The slider becomes inactive. Tap again to re-enable it. |

| Button | Function |
|---|---|
| Voice guidance | Disable verbal instructions. This function is enabled by default. |
| Say Road Names in Native Language Area | Choose from the following options: <ul style="list-style-type: none"> Announce the street names in the native language area of the selected voice guidance language. Announce the road numbers only. Announce the manoeuvres only. |
| Say Road Names in Foreign Language Area | Street names sound correct only if you use a native voice profile for the country. Choose from the following options: <ul style="list-style-type: none"> Try to read the street names in a foreign country. Announce the road numbers only. Announce the manoeuvre only. |
| Early Indication of Manoeuvres | Set whether you want an immediate announcement for the next manoeuvre after each turn, or it is enough to receive the information when the turn is near. |

| | |
|---------------------------------|---|
| Verbosity Level | <p>Set the verbosity of the voice instructions, that is how much they tell and how often they speak.</p> <ul style="list-style-type: none"> • Minimal: the voice instruction is given once right before the next manoeuvre. • Medium: the voice instruction is given when approaching the next manoeuvre and it is repeated right before the manoeuvre. • Verbose: the voice instruction is given first relatively far from the next manoeuvre, it is repeated when approaching the next turn, and it is repeated again right before the actual manoeuvre. |
| Announce Route Summary | Allow reading out a quick summary of the route whenever a route is calculated. |
| Announce Country Info | Allow reading out information about the country you have entered, when you cross country borders. |
| Announce Traffic Info | Allow reading out real-time traffic messages. |
| Announce System Messages | Allow announcing system messages. |

4.3.3 Warnings settings

You can enable and modify the following settings:

| Button | Description |
|--------------------|--|
| Speed Limit | <p>NX405E is able to warn you if you exceed the current speed limit. This information may not be available in your region, or may not be fully correct for all roads on the map.</p> <p>The maximum speed set in the vehicle profile is also used for this warning. NX405E alerts you if you exceed the pre-set value even if the legal speed limit is higher.</p> <p>This setting lets you decide whether you wish to receive visible and/or audible warnings.</p> <p>The following warning types are available:</p> <ul style="list-style-type: none"> • Visual warning: the current speed limit is shown on the map when you exceed it. • Audio and Visual warning: besides the current speed limit being shown on the map, you also receive a verbal warning when you exceed the speed limit with the set percentage. <p>If you prefer to see the speed limit sign on the map all the time (normally, it is shown only if you exceed the limit), you can set it here.</p> <p>You can also set the relative speed above which the application initiates the warning by adjusting a slider. The value can be different within and outside towns.</p> |

| | |
|----------------------------|---|
| <p>Alert Points</p> | <p>Tap it to receive a warning when approaching a road safety camera or other Alert Points like school zones or railroad crossings. You must make sure that using this feature is legal in the country where you intend to use it.</p> <p>You can set the warning type for the different Alert Point categories (alert types) individually. The following warning types are available:</p> <ul style="list-style-type: none"> • Visual warning: the type of the Alert Point, its distance, and the related speed limit appear on the Navigation view while you are approaching one of these locations. • Audio and Visual warning: besides the visual alert, beeps are played (when using a natural voice) or the type of the alert is announced (in case of a TTS voice) while you are approaching one of these points, and an extra alert warns you if you exceed the given speed limit while approaching. <p>For some of the Alert Points, the enforced or expected speed limit is available. For these points, the audio alert can be different if you are below or above the given speed limit.</p> <ul style="list-style-type: none"> • Only when speeding: The audio warning is only played when you exceed the given speed limit. • When approaching: The audio warning is always played when approaching one of these Alert Points. In order to draw your attention, the audio alert is different when you exceed the speed limit. |
| <p>Road Signs</p> | <p>Maps may contain driver alert information that can be shown on the Navigation view in a similar way as real-life road signs. Tap it to enable or disable the warning for these road segments (for example, dangers and sharp curves). For each category of warning signs, set the warning type (visual or audio and visual) and the distance from the hazard to receive the warning at.</p> |

4.3.4 Navigation View settings

These settings allow you to fine-tune the appearance of the Navigation view. You can also adjust how the software helps you navigate with different kinds of route-related information on the Navigation view.

Map Appearance

Tap **Map Appearance** to adjust the navigation view to your needs, choose suitable colour themes from the list for both daytime and nighttime use, show or hide 3D buildings, landmarks, and manage your Place visibility sets (which Places to show on the map).

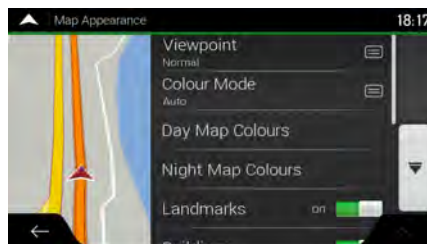

You can modify the following settings:

| Button | Function |
|----------------------------|--|
| Viewpoint Normal | Adjust the basic zoom and tilt levels to your needs. Three levels are available. |
| Colour Mode Auto | Switch between daytime and night colour modes or let the software switch between the two modes automatically a few minutes before sunrise and a few minutes after sunset. |
| Day Map Colours | Select the colour scheme used in daytime mode. Daytime colours are bright and similar to paper road maps. |
| Night Map Colours | Select the colour scheme used in night mode. Night colours are darker to keep the average brightness of the screen low. |
| Landmarks | Show or hide 3D landmarks (3D representations of prominent or well-known objects). |
| Buildings | Show or hide 3D city models (3D block representation of full city building data containing actual building size and position on the map). |
| 3D terrain | Show or hide the 3D elevation of the terrain. |
| Track Logs | Turn on Track Logs to show them on the map or turn them off. |
| Place Markers | Select which Places to show on the map while navigating. Too many Places make the map crowded so it is a good idea to keep as few of them on the map as possible. Tap the name of the Place category to show/hide it or to open the list of its subcategories. |

You can modify the following additional settings on the Navigation View screen:

| | |
|--------------------------------|---|
| Data Fields | If you are navigating with a planned route, you can set three data fields to be displayed on the Navigation view. You can choose from the time of arrival at destination, distance to destination, time to destination, time of arrival at waypoint, distance to waypoint, time to waypoint, heading, or altitude. Without a planned route, there is only one data field that can be set to show the heading or the altitude. |
| Route Progress Bar | Turn the Route Progress Bar on or off. If turned on, an orange line is displayed on the side of the screen, and a blue arrow on it shows your progress. |
| Offer Motorway Services | Turn it on to get motorway service information (for example petrol stations, restaurants) or turn it off if you do not need it. |
| Services Displayed | Select the service types displayed for the motorway exits. Choose from the Places categories. |
| Automatic Overview | Zoom out and show an overview of the surrounding area if the next manoeuvre is far and you are driving on a motorway. When you get close to the event, the normal map view returns. |

| | |
|--|---|
| Signposts | Whenever adequate information is available, lane information similar to the real ones on road signs above the road is displayed at the top of the map. Tap it to turn this feature on or off. |
| Junction View | If you are approaching a motorway exit or a complex intersection and the needed information exists, the map is replaced with a 3D view of the junction. Tap it to turn this feature on or let the map be displayed for the whole route. |
| Tunnel View | When entering tunnels, the surface roads and buildings can be disturbing. Tap it to show a generic picture of a tunnel instead of the map. A top-down overview of the tunnel and the remaining distance are also displayed. |
| Offer Congestion Detour on Highways | In certain situations, NX405E offers a detour when there is a traffic jam on a highway. See page 65. |
| Offer Real Time Alternative Routes | In certain situations, NX405E offers an alternative route when there is a traffic jam on the road. See page 65. |
| Offer Parking Around Destination | In certain situations, NX405E offers parking Places when you approach your destination. See page 66. |
| Offer Hints Upon Detour | In certain situations, NX405E offers different route alternatives when you leave the planned route and suddenly exit the motorway. See page 66. |

4.3.5 Regional settings

You can modify the following settings:

| Button | Description |
|-----------------|--|
| Language | It displays the current written language of the user interface. Tap it to select a new language from the list of available languages. The application restarts after you change this setting and confirm it. |

| | |
|---------------------------------|---|
| <p>Voice Language</p> | <p>It shows the current voice guidance profile. Tap it to select a new profile from the list of available languages and speakers. Tap any of these to hear a sample voice prompt. Just tap  when you have selected the new spoken language.</p> <p>Different voice profiles are capable of different levels of service:</p> <ul style="list-style-type: none"> • Natural Voice (street names not announced): These pre-recorded sounds can only tell you basic information about turns and distances. • TTS Voice (street names announced): These computed voices can read out complex instructions, street names or system messages. • TTS Voice with a microphone icon: Besides the above-mentioned profiles, it can also be used for voice recognition. |
| <p>Units and Formats</p> | <p>You can set the measurement units and time/date format to be used. NX405E may not support all the listed units in some voice guidance languages.</p> |
| <p>Time Zone</p> | <p>By default, the time zone is taken from the map information and adjusted by your current location. Here you can manually set the time zone and the daylight saving time.</p> |

4.3.6 Display settings

You can modify the following settings:

| Button | Function |
|------------------------------|---|
| <p>Menu Animation</p> | <p>When animation is turned on, buttons on menus and keyboard screens, and screen transitions are animated.</p> |

4.3.7 Traffic settings

You can modify the following settings:

| Button | Function |
|--|--|
| <p>Data source Radio & Online</p> | <p>Select what data source you want to use for receiving real-time traffic information:</p> <ul style="list-style-type: none"> • Radio: uses an FM receiver • Online: uses an Internet connection. |

4.3.8 Trip Monitor settings

Trip logs contain useful information about your recorded trips. You can enable and modify the following settings:

| Button | Description |
|--------------------|--|
| Enable auto-saving | Trip monitor can record statistical data of your trips. If you need these logs later, you can let the application save them automatically for you. |
| Save track log | Track logs, the sequence of the positions given by the GPS receiver, can be saved together with trip logs. They can later be displayed on the map. You can let the application save track logs whenever it saves a trip. |
| Trip database size | This is not a button. This line shows the current size of the trip database, the sum of all trip and track logs saved. |

4.3.9 Usage Reports settings

If you enable it when first using the application, it collects usage information and GPS track logs that may be used for improving the application and the quality and coverage of maps. Data are processed anonymously; no one is able to track any personal information.

You can enable or disable collecting the following logs:

| Button | Description |
|-------------------------------|---|
| Application Usage Information | Anonymous statistical information on using the navigation software is collected for later development purposes. Understanding how different people use the application can help us improve the user interface and the program workflow. |
| GPS Tracks | Anonymous track logs are sometimes used for providing real-time information service. Your trips can also help us improve the quality and coverage of maps. |

5 Troubleshooting

This section offers possible solutions to issues that may occur during the operation of NX405E.

5.1 GPS signal cannot be received

Issue: The current location is not available, because GPS signal cannot be received.

Cause 1: GPS signal is weak or may not be available if you are between tall buildings, in garages or tunnels as the signal weakens or distorts as it travels through solid material.

Solution 1: Go to a place where there is a clear sight of the sky or at least a bigger part of the sky is visible.

Cause 2: It may take several minutes to receive GPS signals when first using NX405E, or when your last known position is farther away from your current position.

Solution 2: Wait a few minutes for the GPS signal.

5.2 Address cannot be found

Issue: NX405E cannot find the address you entered.

Cause: The digital map data may not include every single address.

Solution 1: If the house number is not known or NX405E cannot find it, select only the street name. This way, NX405E will navigate you to the midpoint of the street, where you can find the exact address more easily.

Solution 2: Search for another address that is close to the destination.

Solution 3: Search for the coordinates or a nearby Place of Interest.

5.3 The calculated route is not optimal

Issue: The planned route is too long or includes several minor roads.

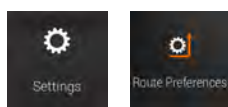

Cause: In ,  the route planning method is not set to the optimal parameter.

Solution: Select your preferred route planning method by performing the following steps:

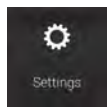
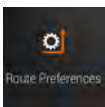
1. Tap , , and .

- Tap **Route Planning Method** and select your preferred route, for example **Fast** or **Easy**. See Page 72.



5.4 Disabling the speed limit warning

Issue: The speed limit warning is signalling even when the actual speed limit is kept.

Cause: The speed limit in the digital map data might differ from the actual speed limit of your current location.

Solution: Disable the speed warning by performing the following steps:

- Tap **Settings**, and **Warnings**.
- Tap **Speed Limit**, **Warn When Speeding** and **Disabled**.

5.5 Keyboard buttons are greyed out

Issue: Some keyboard buttons are greyed out and cannot be used.

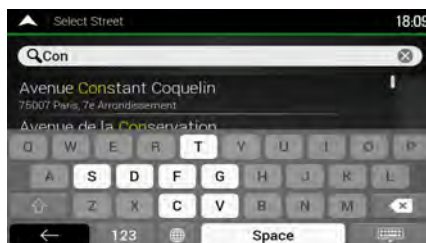

Cause: NX405E has a smart keyboard for address search, which means that only those buttons are active that can be used to type a name that is available on the map.

Solution: Check if you entered the name correctly. If the name is correct, then the address you are looking for is not available in the digital map data.

5.6 The map is hidden behind an image of a junction

Issue: The map is not visible because it is hidden behind an image of a junction.



Cause: If you are approaching a motorway exit or a complex intersection and the needed information exists, the map is replaced with a 3D view of the junction. The lanes you need to take are displayed with arrows.

Solution: If you want to hide the currently displayed junction and return to the Navigation view, tap the picture. To turn off this feature, perform the following steps:

1. Tap ,  Settings, and  Navigation View.
2. Tap  Tunnel View. Now the tunnel view will not appear again.

6 End-user licence agreement

0. Definitions

The following terms shall have the meaning defined hereunder in this agreement when used with capital letters. The text of this agreement may also contain further defined terms.

“Agreement” means this End User Licence Agreement (EULA) containing the terms and conditions of use of the Software, Databases and Services by You as the end user.

“Database” or “Database Content” means geographically referenced data such as map data, points of interest (“POI”), 3D models, TMC location tables, phonemes, images, audio or video files and other data, as well as any data suitable for integration into the Software.

“Device” means the hardware equipment manufactured or distributed by Licensor on which the Navigation Product is installed.

“Software” means the turn-by-turn navigation software installed on the Device, including the core engine, other software modules and the graphical user interface, capable of processing and/or displaying the Databases and the Services. The term Software shall by definition include any modifications, updates, upgrades thereto.

“Service” means the provision of dynamically changing information that may be provided by-, displayed by- or transmitted through the Software, for example, but not limited to Traffic Message Channel (TMC) service, search, weather information and community based services. Services are usually transmitted online via the Internet, but may be conveyed via other means (e.g. via radiowaves in case of “RDS TMC” service).

“Navigation Product” means the Software, the Databases and the Services together, as (i) distributed with the Device by the Licensor or (ii) otherwise installed on the Device.

1. The contracting parties

1.1 This Agreement has been entered into by and between You as the end user (hereinafter: “User”) and the business entity distributing/selling the Device together with the Navigation Product, under its own name and/or branding (hereinafter: “Licensor”). This Agreement sets out the conditions and limitations of use of the Navigation Product. The User and the Licensor are referred together as: “Parties”.

1.2 User represents and warrants that (i) he/she is not located in a country that is subject to a U.S. Government embargo, or that has been designated by the U.S. Government as a “terrorist supporting” country; and (ii) he/she is not listed on any U.S. Government list of prohibited or restricted parties.

2. Conclusion of the Agreement

2.1 This Agreement is concluded by implicit conduct of the Parties without signing the Agreement.

2.2 The User hereby acknowledges that following the lawful acquisition of the Navigation Product constituting the object of this Agreement, any of the following actions of use shall mean that the User has accepted the terms and conditions of this Agreement as legally binding: (i) any degree of use, installation onto a computer or other Device (mobile phone, multi-function device, personal navigation device, in-car navigation or multi function head unit, etc.), (ii) pressing the “Accept” button displayed by the Navigation Product during installation or use. The time of conclusion of the present Agreement is the time of executing the first action of use (commencement of use).

2.3 This Agreement shall by no means authorize the usage of the Navigation Product by those persons having unlawfully acquired the Navigation Product or having unlawfully installed it on a Device or in a vehicle.

2.4 U.S. Government Users. If you acquire the Navigation Product by or on behalf of the United States Government or any other entity seeking or applying rights similar to those customarily claimed by the United States Government, you are on notice that the Navigation

Product is a commercial item as that term is defined at 48 C.F.R ("FAR") 2.101 and that all use of the Navigation Product is subject to this Agreement.

3 Applicable law and venue

3.1 This Agreement will be governed by the laws of the country where the Licensor has its statutory seat or in the absence of such incorporation where it has its central administration ("country of residence") without regard to such country's choice of law provisions.

3.2 The courts of the country of residence specified in Section 3.1. above shall have jurisdiction over all disputes related to this Agreement.

3.3 If the User is a "consumer" (a natural person who purchased and uses the Navigation Product for purposes outside its business activities or which can be regarded as being outside his trade or profession), the above choice of law and choice of venue shall not, have the result of depriving the consumer of the protection afforded to him by provisions (including any provision regulating the court having jurisdiction) that cannot be derogated from by agreement by virtue of the law which, in the absence of choice, would have been applicable.

3.4 The United Nations Convention on Contracts for the International Sales of Goods is hereby excluded from application to this Agreement.

4. Object of the Agreement and Termination

4.1 The object of this Agreement shall be the Navigation Product as a whole and the components (the Software, the Databases and the Services) thereof. User acknowledges that all author's rights (including the economic rights) vested in the Software are owned by NNG Software Developing and Commercial Ltd. (registered seat: 35-37 Szépvölgyi út, H-1037 Budapest, Hungary; company reg.no.: 01-09-891838, <http://www.nng.com>), herein referred to as: Software Owner.

4.2 Any form of display, storage, coding, including printed, electronic or graphic display, storage, source or object code, or any other as yet undefined form of display, storage, or coding, or any medium thereof shall be deemed parts of the Navigation Product.

4.3 Error corrections, updates or upgrades or any other modifications to the Navigation Product used by the User following the conclusion of this Agreement shall also be used in accordance with this Agreement.

4.4 Your rights under this Agreement will terminate immediately without notice from Licensor if you materially breach them, or take any action in derogation of the rights of Licensor, any suppliers holding rights in the Navigation Product and/or their suppliers. Licensor may terminate this Agreement if the Navigation Product as a whole or any part thereof becomes, or in Licensor's (or other suppliers holding rights in the Navigation Product) reasonable opinion likely to become, the subject of a claim of intellectual property infringement or trade secret misappropriation. Upon termination, you will cease use of, and delete the Navigation Product and confirm compliance in writing to Licensor, if requested.

4.5 Licensor reserves the right to upgrade, modify, withdraw, suspend, or discontinue any Service offering, functionality or feature of the Navigation Product or may terminate distribution of the Navigation Product in its sole discretion due to reasons such as (but not limited to): the provision is no longer financially or otherwise feasible for Licensor, technology advances, or conditions rules change, end user feedback indicates a change or is needed, agreements with third parties no longer permit us to make their Databases or Services available, or external issues arise that make it imprudent or impractical to continue with the provision.

4.6 Licensor reserves the right to replace any Database or Service with another Database or Service having the same or similar functionality. Such change may be executed upon the sole discretion of Licensor.

5. Rights under copyright or other intellectual property rights

5.1 All material copyrights and other intellectual property rights vested in the Navigation Product or any parts thereof, that are not explicitly granted in this Agreement or by virtue of law, are reserved.

5.2 Intellectual property rights of Licensor, the Software Owner or other rightholders extend to the whole Navigation Product and to its parts separately as well.

5.3 The owner(s) of the copyrights of the Database(s) is (are) the Licensor, or natural person(s) or corporate business entity(ies) (referred to as: "Database Owner") who supply them. In the event that the copyright owner of the Database is not the Licensor, the Licensor hereby states that it has obtained sufficient usage and representation rights from the Database Owners in order to utilize the Databases in line with this Agreement.

5.4 Services available through the Software may transmit various types of information or content to the User, which information or content is gathered and provided by third party service providers. Therefore it is understood and accepted that neither the Licensor nor the Software Owner has the ability or right to control, alter or modify such information and content and the Service itself is only a function enabling the Software to access, download and display information and content to the User.

5.5 Database Owners, service providers and any special terms and conditions regarding their products contained in- or displayed through the Navigation Product may be listed in the "About" or similar menu item of the Navigation Product, or in in the Device documentation or at a website address indicated in the "About" section.

6. Rights of the User

6.1 Without prejudice to Section 6.2 below, by default the User is entitled to run the Navigation Product on the Device the Navigaiton Product came preinstalled before purchase or on the Device in connection which the Navigation Product was provided by Licensor, and to run and use one copy of the Navigation Product or a preinstalled copy of the Navigation Product thereon. The Navigation Product is for the User's personal purposes only.

6.2 In the event that the Navigation Product comes preinstalled on- or otherwise licensed together with the Device or acquired from Licensor by the User for a specific Device, the Navigation Product shall be tied to the Device and may not be separated-, transferred to-, or used with another Device or sold to another User without selling the Device itself.

6.3 The Databases and Services provided to the User may only be used together with User's copy of the Software and may not be used separately or with another copy of the Software.

7. Limitations of use

7.1 The User is not entitled

7.1.1 to duplicate the Navigation Product (to make a copy thereof) or any part of it, except to the extent allowed by this Agreement or applicable law;

7.1.2 to resell, sublicense, lease, rent or lend it, or to transfer it to a third person for any reason without transferring the Device on which it was first legally installed on (see section 6.2);

7.1.3 to translate the Navigation Product (including translation (compilation) to other programming languages);

7.1.4 to decompile, disassemble, or reverse engineer the Navigation Product;

7.1.5 to evade the protection of the Navigation Product or to modify, circumvent or obviate such protection through technological or by any other means;

7.1.6 to modify, extend, transform the Navigation Product (in whole or in part), to separate it into parts, combine it with other products, install it in other products, utilize it in other products, not even for the purpose of achieving interoperability with other devices;

7.1.7 to remove, modify or obscure any copyright, trademark notice, or restrictive legend included in the Navigation Product or any part thereof.

7.2 The User may only use the Databases and information from the Services available through the Navigation Product (including but not limited to the traffic data received from the RDS TMC or on-line TMC traffic information service) for his/her own benefit and at his/her own risk. It is strictly prohibited to store, to transfer or to distribute these data or contents or to

disclose them in full or in part to the public in any format or to download them from the Navigation Product.

8. No warranty, limitation of liability

8.1 The Licensor hereby informs the User that although the greatest care was taken in producing the Navigation Product, given the nature of the Navigation Product and its technical limitations, the Licensor and its suppliers do not provide a warranty for the Navigation Product being completely error-free, and they are not bound by any obligation whereby the Navigation Product obtained by the User should be completely error-free.

8.2 THE LICENSED NAVIGATION PRODUCT, INCLUDING ANY OF THE DATABASES, OR SERVICES FORMING PART THEREOF ARE PROVIDED ON AN "AS IS" AND "WITH ALL FAULTS BASIS" (INCLUDING NO WARRANTY FOR THE CORRECTION OF FAULTS) AND LICENSOR, THE DATABASE OWNERS, THE SOFTWARE OWNER, THE SERVICE PROVIDERS AND THIRD PARTY SUPPLIERS EXPRESSLY DISCLAIM ALL WARRANTIES, EXPRESS OR IMPLIED, INCLUDING BUT NOT LIMITED TO, THE IMPLIED WARRANTIES OF NON-INFRINGEMENT, MERCHANTABILITY, SATISFACTORY QUALITY, ACCURACY, TITLE AND FITNESS FOR A PARTICULAR PURPOSE. NO ORAL OR WRITTEN ADVICE OR INFORMATION PROVIDED BY LICENSOR OR ANY OF ITS AGENTS, SUPPLIERS, EMPLOYEES, THIRD PARTY PROVIDERS, THE SOFTWARE OWNER OR THE DATABASE OWNERS AND SERVICE PROVIDERS SHALL CREATE A WARRANTY, AND USER IS NOT ENTITLED TO RELY ON ANY SUCH ADVICE OR INFORMATION. THIS DISCLAIMER OF WARRANTIES IS AN ESSENTIAL CONDITION OF THE AGREEMENT.

Licensor does not warrant that the Navigation Product is capable of interoperating with any system, device or product.

8.3 The Licensor does not assume any responsibility for damages incurred due to an error in the Navigation Product.

8.4 The Licensor does not assume any responsibility for damages incurred due to the Navigation Product not being applicable for any defined purpose, or due to the error or incompatibility of the Navigation Product with any other system, device or product.

8.5 NEITHER LICENSOR NOR ITS SUPPLIERS SHALL BE LIABLE TO USER FOR ANY INCIDENTAL, CONSEQUENTIAL, SPECIAL, INDIRECT OR EXEMPLARY DAMAGES ARISING OUT OF THIS AGREEMENT, INCLUDING LOST PROFITS OR COSTS OF COVER, LOSS OF USE OR BUSINESS INTERRUPTION OR THE LIKE, REGARDLESS OF WHETHER THE PARTY WAS ADVISED OF THE POSSIBILITY OF SUCH DAMAGES.

NOTWITHSTANDING ANYTHING TO THE CONTRARY CONTAINED HEREIN, THIRD PARTY SUPPLIERS (E.G. DATABASE OWNERS, MAP PROVIDERS, SERVICE PROVIDERS, THE SOFTWARE OWNER) OR AGENTS OF LICENSOR SHALL HAVE NO MONETARY LIABILITY TO THE USER FOR ANY CAUSE (REGARDLESS OF THE FORM OF ACTION) UNDER OR RELATING TO THIS AGREEMENT.

IF YOU HAVE ANY BASIS FOR RECOVERING DAMAGES FROM LICENSOR OR ANY OF ITS SUPPLIERS, YOU CAN RECOVER ONLY DIRECT DAMAGES UP TO THE AMOUNT THAT YOU PAID FOR THE NAVIGATION PRODUCT (OR UP TO 10 USD IF THE AMOUNT IS NOT CALCULABLE OR IF YOU ACQUIRED THE NAVIGATION PRODUCT FOR NO CHARGE). THE DAMAGE EXCLUSIONS AND LIMITATIONS IN THIS AGREEMENT APPLY EVEN IF REPAIR, REPLACEMENT OR A REFUND FOR THE NAVIGATION PRODUCT DOES NOT FULLY COMPENSATE YOU FOR ANY LOSSES OR IF THE LICENSOR OR ITS SUPPLIERS KNEW OR SHOULD HAVE KNOWN ABOUT THE POSSIBILITY OF THE DAMAGES.

8.6 The Licensor also draws the attention of the User to the fact that, when using the Navigation Product in any form of vehicle, observing the traffic regulations and rules (e.g. use of obligatory and/or reasonable and suitable security measures, proper and generally expected care and attention in the given situation, and special care and attention required due to the use of the Navigation Product) is the exclusive responsibility of the User. The Licensor shall not assume any responsibility for any damages occurred in relation to use of the Navigation Product in any vehicle.

Safety (e.g. speed) cameras are provided for informational purposes only and may not be used to encourage, facilitate or support the violation of any laws. Furthermore some countries prohibit the display or use of such features. Compliance with country specific laws and any usage or reliance on the information by user shall be at the User's own risk and sole responsibility.

8.7 Database and Services provided by third parties. The Licensor hereby excludes any liability of its own for the Database or information obtained through the Services in the Navigation Product. The Licensor does not warrant the quality, suitability, accuracy, fitness for a specific purpose or territorial coverage or availability of the Database or information. The Licensor specifically excludes any and all liability for the suspension or cancellation of any of the Services, and any damage arising due to cancellation of a Service. User acknowledges that the mapping data in Databases may contain geographical data and other data.

8.8 The User hereby acknowledges that (i) inaccurate or incomplete information due to the passage of time, changing circumstances, sources used and the nature of collecting comprehensive geographic data, may each lead to incorrect results; and (ii) that the Database or information obtained through the Services provided by third parties may only be used at the risk of the User and for the benefit of the User. User acknowledges that the Databases are the confidential information of Database Owners and disclosure of the Databases to third parties is prohibited.

8.9 USE OF THE NAVIGATION PRODUCT'S REAL TIME ROUTE GUIDANCE FUNCTION IS AT USER'S SOLE RISK AS LOCATION DATA MAY NOT BE ACCURATE.

8.10 Database Content and Services provided by the Licensor or an agent of the Licensor. For certain Navigation Products the Licensor or the Software Owner or a contractual partner may offer various products and services to the User through the <http://www.naviextras.com> or another dedicated website. The User may only use these services when the User has read and understood the relevant terms at the website and the User is obliged to use the services in line with those terms. In the event of conflict between this Agreement and such additional terms, the additional terms shall prevail.

8.11 Purchase and acquisition of activation licence for the use of certain functions, Databases, or Services may require Internet connection and no alternative way of acquisition is offered by Licensor or the supplier of those functions, Databases, or Services.

9. Sanctions

9.1 The Licensor hereby informs the User that the breach of copyrights and related rights is a crime under numerous jurisdictions, including in the United States of America and other countries who ratified the International Convention on Cybercrime.

9.2 Licensor, Software Owner and suppliers of products on the basis of this Agreement are continuously monitoring violation of their intellectual property rights, and in case infringing use is detected, violators will face criminal and civil procedures initiated against them in any and all jurisdictions.

10. Anonymous data collection

10.1 The User hereby acknowledges that the Software may collect, transmit to Licensor or third parties, and in some cases stores data connected to the usage of the Software by the User (e.g. movement/route data, user interaction data). Such data collection functions may be disabled or enabled by User any time from within the corresponding menu within the Navigation Product. The collected data is always anonymous, not associated in any way with any personal information of the User or with the User itself.

10.2 The collected data may be uploaded to the Software Owner's database or transmitted periodically or in real time to a third party partner and used exclusively for the purpose of enhancing and improving the precision and reliability of features and services of the Navigation Product. Uploading is executed through the Software Owner's special software or by the Device, and the upload may be enabled or disabled by User. After successful data upload, the collected data is deleted from the Navigation Product and the Device or may be deleted by the User manually.

10.3 Collected data is transmitted, stored and handled anonymously and no connection of the data with the User shall be established by Licensor or any third party.

10.4 Licensor hereby informs the User, that if it accesses the Internet through mobile data service while abroad or otherwise roaming another mobile network the transmission of such data may result in special roaming charges. To avoid such charges it is the responsibility of the User to disable mobile data services while roaming or to turn off the data collection functions of the Navigation Product.

11. Auxiliary Terms for Services

11.1 For online Services the following auxiliary terms shall also apply. Information or Database content (e.g. weather-, traffic information, location based information, online search results) may be transmitted to the User's Device through an Internet connection ("Connected Services"). Connected Services may be granted for a fee or free of charge subject to Licensor's decision.

11.2 Information and content through Connected Services in general are not available in all countries, or all languages, furthermore different conditions and service characteristics may apply in different countries. Use of certain Connected Services may be prohibited in certain countries. It is the User's responsibility to comply with country specific regulation. Licensor excludes its liability for the consequences of illegal use of such functions and User shall indemnify and hold Licensor harmless from all claims against Licensor from authorities or third parties due to the illegal use.

11.3 Online information and content are downloaded by the Navigation Product from the Software Owner's or other suppliers' online content servers. The Licensor hereby excludes any liability of its own for all information and content. As no control may be exercised by the Licensor or the Software Owner over the information or content, neither Licensor nor Software Owner warrants the legality, quality, suitability, accuracy, fitness for a specific purpose or territorial coverage of the information and content, furthermore no warranty is offered regarding the availability (e.g. uptime) of online information and content servers. User acknowledges that in any territory or time, slow- or non-connectivity may be experienced due to capacity limitations of the Internet connection or the content servers. The Navigation Product may allow the User to access and communicate third party servers directly. In such cases use of such servers is for User's own risk entirely. Licensor shall not undertake any liability whatsoever for such servers and services accessed and received directly from third parties.

Server availability. No warranty is provided regarding the availability of the servers enabling the Services. When conducting periodic maintenance and inspection of the servers providing the Service (the "System") upon which Services operate, Licensor (or its Supplier) may temporarily suspend all or part of the Services. In the case of any of the following items, Licensor (or its Supplier) may temporarily interrupt all or part of the Service without prior notification to the User:

- (i) When conducting emergency maintenance or inspection of the System;
- (ii) When it becomes no longer possible to provide operate the System due to an accident such as fire or power outages, natural disasters such as an earthquakes or flooding, war, rioting, industrial disputes, etc.;
- (iii) When Licensor deems it necessary to temporarily suspend operation due to unavoidable operational or technical circumstances; or
- (iv) When it becomes no longer possible to provide the Service due to a System failure, etc.

11.4 User acknowledges that the data or information provided through Connected Services is not updated in real-time and may not accurately reflect the real life situation or events.

11.5 The User hereby acknowledges that the Connected Services may only be used at the risk of the User and for the benefit of the User. It is the sole responsibility of the User to provide and maintain a connection to the public Internet network. User accepts that the usage of the Connected Services generates data traffic (up- and downstream) and may result in increased mobile data service fees payable by User.

11.6 Connected Services may provide data, information or materials supplied and/or licensed by third parties to Licensor. For such materials different terms and conditions imposed by such third parties may apply. Applicable third party terms shall be listed in the “About” section of the Navigation Product, in the Device documentation, at a website address indicated in the “About” section or as part of this Agreement. When first using / enabling Connected Services, User accepts compliance with those third party terms and conditions.

11.7. Community Services. Some Connected Services may be based on data and information uploaded by participating individuals (Users or other persons) or a Database created and maintained by a group of such individuals. Such data may not come from a trusted source and may also be intentionally false or misleading, as Licensor or Software Owner does not have any means to control or verify the credibility or accuracy of such data or the individuals providing the data. Therefore User accepts that community type Connected Services must be used with extreme care.

By participating in the community by providing data or any information via the Navigation Product or other means offered by Licensor (e.g. through a website or other software), User shall accept the following:

- (a) Licensor is granted a royalty-free right to use the data uploaded, in particular, to modify, display, make available to the public, distribute, copy the data for any purpose;
- (b) User warrants that no third party has any rights that would hinder or render impossible the use of the data as set out in (a) above, and that no third party rights are infringed by uploading the data on those conditions;
- (c) User indemnifies and holds harmless Licensor from any claim from a third party against Licensor due to violation of its rights regarding the uploaded data.

12. Third party supplier terms

12.1 Third parties supply Services or Database built into the Navigation Product and such third party suppliers may have special terms and conditions of use (“Supplier Terms”), and You as the User accept those terms together with this Agreement.

12.2 Potential third party suppliers (and their Supplier Terms) may have their Database or Service distributed as part of the Navigation Product are listed in the “About” section of the Navigation Product or at a website address indicated in the “About” section.

12.3 Service specific terms:

12.3.1 **Online Search.** By using the built in online search functionality the User hereby acknowledges that during the search process the geographic position of the User’s device may be used for providing better search results. Also the search result chosen by the User may be processed anonymously by the Service supplier for statistical purposes.

When using the online search functionality the User may not (i) interfere with the performance of the Service; (ii) complete mass downloads or bulk feeds of any content or information derived from the Service or information acquired therefrom, use benchmarking methods, e.g., robots, to access or analyze the Service or information derived therefrom, and (iii) alter or manipulate the Service or information derived therefrom or modify the default settings operation or look and feel of the Service (including but not limited to displayed logos, terms and notices); or (iv) use the Service or information derived therefrom in connection with any unlawful, offensive, obscene, pornographic, harassing, libelous or otherwise inappropriate content or material, furthermore (v) use search results to generate sales lead information in the form of ASCII or other text-formatted lists of category-specific business listings which (x) include complete mailing address for each business, and (y) contain a substantial portion of such listings for a particular county, city, state, or zip code region.

12.3.2 Traffic. Neither the traffic information nor any derivatives thereof shall be used by the User for (i) historical data purposes (including but not limited performing storage of the data in order to enable the collection or analysis of information); or for (ii) broadcasting or making available to any third party; and (ii) for the purpose of enforcement of traffic laws including but not limited to the selection of potential locations for the installation of speed cameras, speed traps or other speed tracking devices.

Traffic data may not be archived and may only be delivered for Users' near term personal use not to exceed one twenty-four hour period.

13. Third party attribution

Attribution of third parties (e.g. copyright notices) supplying software modules, Databases, Services or other material to the Navigation Product are listed in the "About" section of the Navigation Product or at a website address indicated in the "About" section.

7 Copyright note

The product and the information contained herein are subject to change without prior notification.

This manual may not, in whole or in part, be reproduced or transmitted in any form either electronically or mechanically, including photocopying and recording, without the express written consent of Clarion.

© 2015 - Clarion

Map data: © 1987 - 2015 HERE. All rights reserved. See http://corporate.navteq.com/supplier_terms.html.

All rights reserved.