

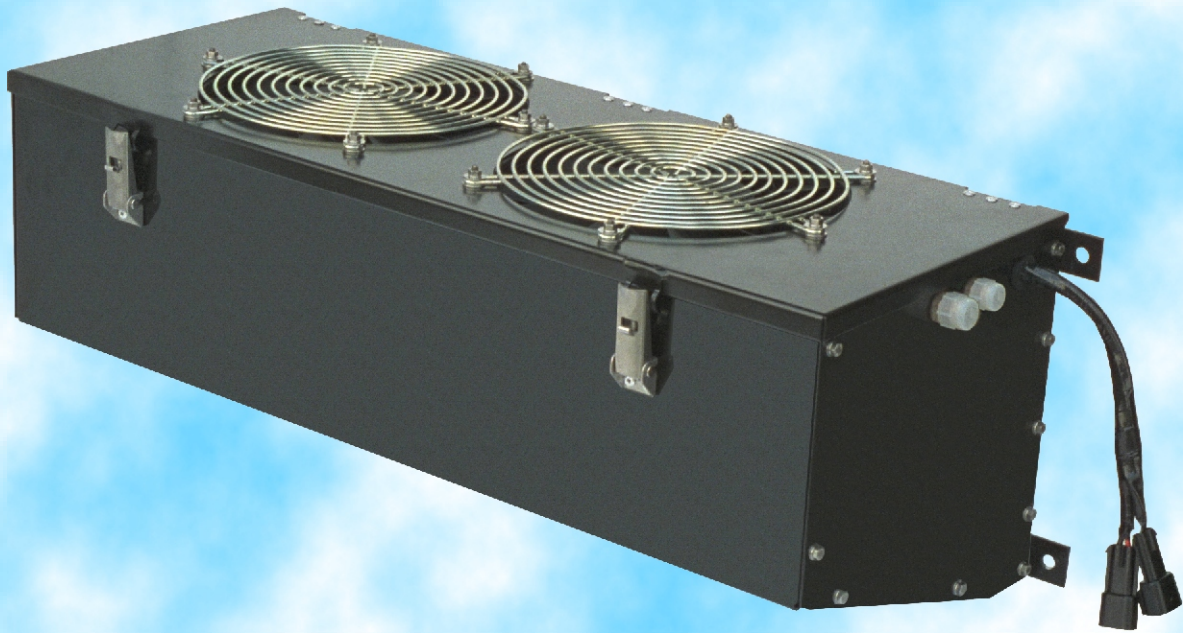

**AUTOCLIMA**  
QUALITY & COMFORT

## CONDENSATORE

**KW 47**





**DENVER**  
AIR CONDITIONERS



 Condensatore elettroventilato completo di filtro deidratore e pressostato trinary, racchiuso in una robusta struttura per il montaggio a parete su veicoli lavori pubblici e macchine agricole.

 Condenseur electroventilé avec filtre déshydrateur et pressostat à trois niveaux, ayant une robuste structure pour le montage à paroi sur véhicules TP et machines agricoles.

 Electroventilated condenser with dryer filter and three levels switch, enclosed in a strong frame for installation on agricultural, construction and building machines.

 Kondensator mit Electrolüfter mit Trockner und Druckschalter Trinary. Es ist enthalten in einer starken Struktur für die Montage am Wand auf Fahrzeuge für öffentliche Arbeiten und Landmaschinen.

 Condensador electroventilado con filtro y presostato trinary, incluido en una robusta carcasa para el montaje en pared sobre vehiculos de obras publicas y maquinarias agricolas.

CONDENSATORE KW 47

12V cod.30301017

CONDENSATORE KW 47

24V cod.30301018

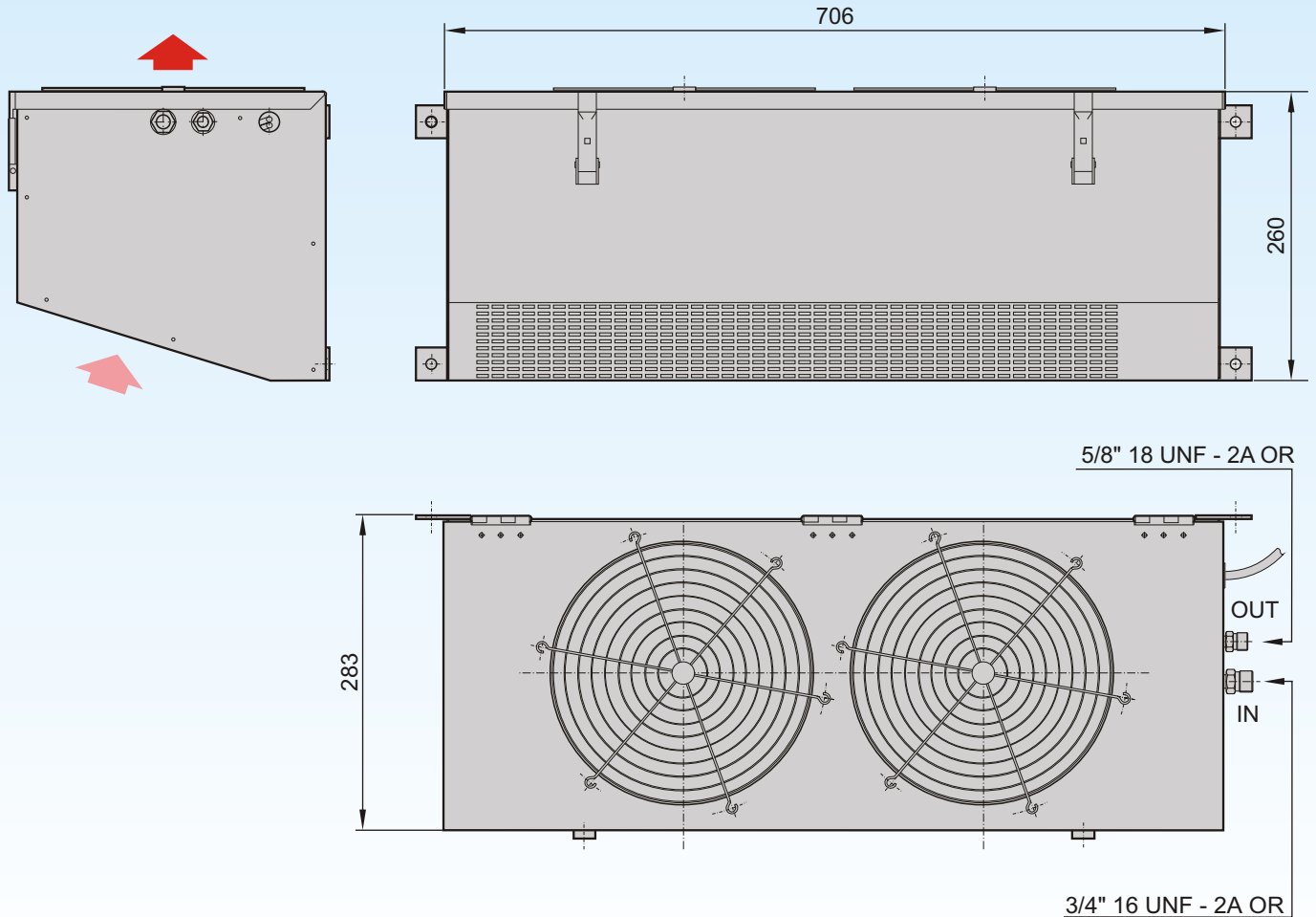

Dati tecnici nominali	Données techniques nominales	Nominal technical data	Technische Nominal-Eigenheiten	Datos técnicos	<b>KW 47</b>
• Potenza max. evaporatore abbinabile	• Puissance frigorifique évaporateur correspondant	• Cooling capacity of matching evaporator	• Kälteleistung entspr. verdampfer	• Potencia frigorífica del evaporador correspondiente	<b>6 kW</b> <b>12V c.c / 24V c.c</b> <b>13A (12V) / 6,5A (24V)</b> <b>1600 m<sup>3</sup>/h</b> <b>21 Kg</b>
• Tensione alimentazione	• Tension d'alimentation	• Working voltage	• Spannung	• Tension de alimentación	
• Assorbimento elettrico	• Absorption électrique	• Power consumption	• Stromverbrauch	• Intensidad absorbida	
• Portata aria	• Débit air	• Air flow	• Gebläseleistung	• Caudal de aire	
• Peso	• Poids	• Weight	• Gewicht	• Peso	

La nostra società si riserva il diritto di migliorare e modificare ciascuno dei modelli illustrati, senza alcun preavviso.

Notre Société se réserve le droit d'améliorer et de modifier sans aucun préavis chacun des modèles ci-illustrés.

The company reserves the right to modify any design in the model without prior notice as per our policy of continuous improvement of design, quality and performance.

Unsere Firma behält sich das Recht vor, jeden Modell hier erläutert ohne Vorankündigung zu ändern und verbessern.

La compañía se reserva el derecho a modificar cualquier diseño en los modelos sin previo aviso debido a la política de continua mejora en el diseño, en la calidad y en el rendimiento



Autoclima S.p.A. - 10020 Cambiano (TO) - ITALY  
 Via Cavalieri di Vittorio Veneto, 15 - Tel. 011.94.43.210 - Fax 011.94.43.230  
 Internet: <http://www.autoclima.com> e-mail: [sales@autoclima.com](mailto:sales@autoclima.com)

STAMPATO IN ITALIA - RIPRODUZIONE VIETATA

Cod. \_\_\_\_\_