

clarion®

Owner's manual
Mode d'emploi
Manual de instrucciones
Istruzioni per l'uso
Bedienungsanleitung

CMD6

WATERTIGHT MARINE CD/USB RECEIVER
LECTEUR MARIN CD/USB ÉTANCHE
RECEPTOR CD/USB MARINO HERMÉTICO
LETTORE CD/RICEVITORE USB MARINO IMPERMEABILE
WASSERDICHTER MARINER CD/USB RECEIVER

CAUTIONS:

This appliance contains a laser system and is classified as a "CLASS 1 LASER PRODUCT". To use this model properly, read this Owner's Manual carefully and keep this manual for your future reference. In case of any trouble with this player, please contact your nearest "AUTHORIZED service station". To prevent direct exposure to the laser beam, do not try to open the enclosure.

!CAUTION

USE OF CONTROLS OR ADJUSTMENTS OR PERFORMANCE OF PROCEDURES OTHER THAN THOSE SPECIFIED IN THE OWNER'S MANUAL MAY RESULT IN HAZARDOUS RADIATION EXPOSURE.

ADVARSEL.

Denne mærkning er anbragt udvendigt på apparatet og indikerer, at apparatet arbejder med laserstråler af klasse 1, hvilket betyder, at der anvendes laserstråler af svageste klasse, og at man ikke på apparatets yderside kan blive udsat for utilladelig kraftig stråling.

APPARATET BØR KUN ÅBNES AF FAGFOLK MED SÆRLIGT KENDSKAB TIL APPARATER MED LASERSTRÅLER!

Indvendigt i apparatet er anbragt den her gengivne advarselmærkning, som advarer imod at foretage sådanne indgreb i apparatet, at man kan komme til at udsætte sig for laserstråling.

OBS!

Apparaten innehåller laserkomponenten som avger laserstråling överstigande gränsen för laserklass 1.

VAROITUS

Suojakoteloä si saa avata. Laite sisältää laserdiodin, joka lähettää näkymätöntä silmille vaarallista lasersäteilyä.

CE	MODEL <input type="text"/>	clarion EMCTYPE 104XXXX
12V GROUND	USA: AM 530-1710kHz / FM 87.9-107.9MHz	
15A Load 4Ω	EUROPE: AM 531-1602kHz / FM 87.5-108MHz	
	AUSTRALIA: AM 531-1629kHz / FM 87.0-108MHz	
THIS DEVICE COMPLIES WITH PART 15 OF THE FCC RULES, OPERATION IS SUBJECT TO THE FOLLOWING TWO CONDITIONS: (1) THIS DEVICE MAY NOT CAUSE HARMFUL INTERFERENCE, AND (2) THIS DEVICE MUST ACCEPT ANY INTERFERENCE RECEIVED, INCLUDING INTERFERENCE THAT MAY CAUSE UNDESIRABLE OPERATION.		
THIS PRODUCTION COMPLIES WITH DHHS RULES 21 CFR SUBCHAPTER J APPLICABLE AT DATE OF MANUFACTURE.		
CLARION CO., LTD. 7-2 SHINTOSHIN, CHUO-KU, SAITAMA-SHI, SAITAMA, JAPAN		
This product includes technology owned by Microsoft Corporation and cannot be used or distributed without a license from MSLGP.		
CLASS 1 LASER PRODUCT		
051 722 877		
SERIAL No. <input type="text"/>	<input type="text"/>	Clarion Co., Ltd.

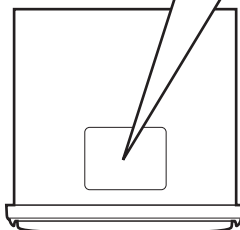

Thank you for purchasing this **Clarion** product.

- * Please do not use this product on vehicles.
- * Please read this owner's manual in its entirety before operating this equipment.
- * Check the contents of the enclosed warranty card and keep it carefully with this manual.

Contents

1. FEATURES	3
2. PRECAUTIONS	4
3. CONTROLS	6
Names of the Buttons and Their Main Functions	6
4. REMOTE CONTROL	8
Optional Wired Remote Control Unit Operations	8
Wireless Remote Control Unit Operations	10
Inserting the Battery	11
5. OPERATIONS	12
Basic Operations	12
Radio Operations	14
CD/MP3/WMA/AAC Operations	16
Operations Common to Each Mode	19
6. ACCESSORIES	21
USB/MTP Operations	21
iPod Operations.....	23
CD Changer Operations.....	25
7. TROUBLESHOOTING	26
8. ERROR DISPLAYS	28
9. SPECIFICATIONS	29
10. OTHERS	30

1. FEATURES



- Watertight Front Panel/Chassis
- BBE MP for compressed audio improvement
- Low Consumption Wating As Power Off

2. PRECAUTIONS

This equipment has been tested and found to comply with the limits for a Class B digital device, pursuant to Part 15 of the FCC Rules.

These limits are designed to provide reasonable protection against harmful interference in a residential installation.

This equipment generates, uses, and can radiate radio frequency energy and, if not installed and used in accordance with the instructions, may cause harmful interference to radio communications. However, there is no guarantee that interference will not occur in a particular installation.

If this equipment does cause harmful interference to radio reception, which can be determined by turning the equipment off and on, the user is encouraged to consult the dealer or an experienced radio technician for help.

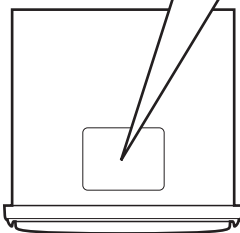

Bottom View of Source Unit

⚠ CAUTION

USE OF CONTROLS, ADJUSTMENTS, OR PERFORMANCE OF PROCEDURES OTHER THAN THOSE SPECIFIED HEREIN, MAY RESULT IN HAZARDOUS RADIATION EXPOSURE.

THE COMPACT DISC PLAYER SHOULD NOT BE ADJUSTED OR REPAIRED BY ANYONE EXCEPT PROPERLY QUALIFIED SERVICE PERSONNEL.

CHANGES OR MODIFICATIONS NOT EXPRESSLY APPROVED BY THE MANUFACTURER FOR COMPLIANCE COULD VOID THE USER'S AUTHORITY TO OPERATE THE EQUIPMENT.

INFORMATION FOR USERS:

CHANGES OR MODIFICATIONS TO THIS PRODUCT NOT APPROVED BY THE MANUFACTURER WILL VOID THE WARRANTY AND WILL VIOLATE FCC APPROVAL.

Front Panel

This unit uses a flip-down structure that makes possible large-size displays.

CAUTION

When opening and closing the front panel, be careful not to catch your fingers. They could be injured.

1. Always use this unit with the front panel closed.
2. Do not force operations or use this device abnormally when opening or closing the front panel.
3. Do not use the front panel as a tray to place objects on when it is open.
4. When closing the front panel, do not press the [OPEN] button.
5. Strong impacts to the operating or display section can cause damage or deformation.
6. If the front panel does not open fully, gently open it with your hand.
7. Do not touch the panel OPEN detection switch.

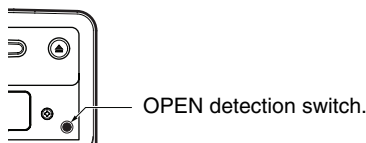

Handling Compact Discs

- Compared to ordinary music CDs, CD-R and CD-RW discs are both easily affected by high temperature and humidity and some of CD-R and CD-RW discs may not be played. Therefore, do not leave them for a long time in the boat.
- Never stick labels on the surface of the compact disc or mark the surface with a pencil or pen.

Display Screen

In extreme cold, the screen movement may slow down and the screen may darken, but this is normal.

The screen will recover when it returns to normal temperature.

3. CONTROLS

Names of the Buttons and Their Main Functions

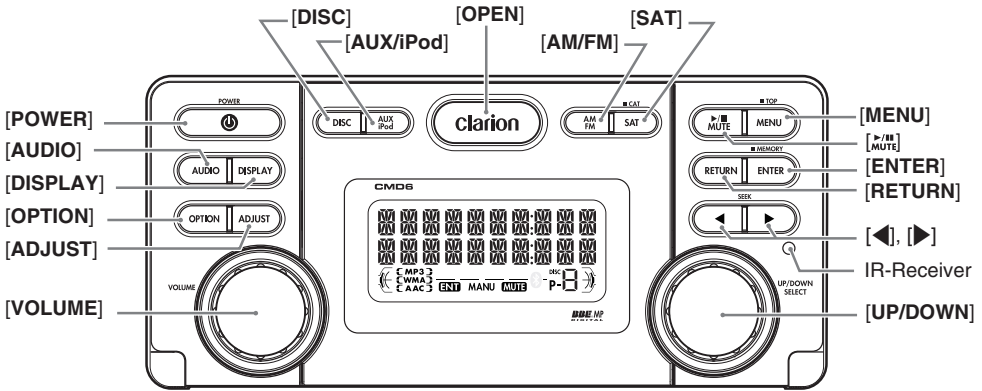

With the front panel opened

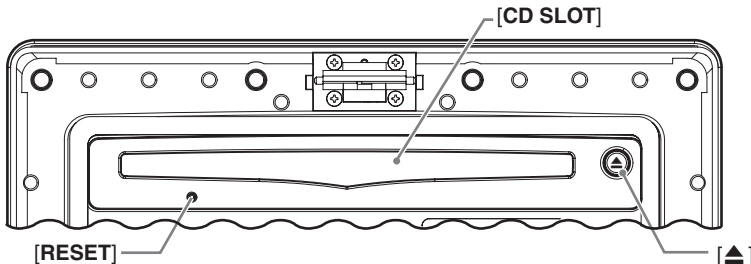

[DISC] button

- Use to switch to CD/MP3/WMA/AAC or CD changer mode.

[AUX/iPod] button

- Use to switch to USB/iPod mode or AUX mode.

[OPEN] button

- Open the panel by pressing the “Clarion” oval latch button. Audio will mute with the front panel open.

[AM/FM] button

- Use to switch to radio mode.
- Switch the band.
- Press and hold the button to switch to seek or manual tuning.

[SAT] button

- Not in use.

[MENU] button

- Use to switch to the menu mode.

[MUTE] buttons

- Press and hold the button (1 sec.) to play or pause.
- Turn the mute on/off.

[ENTER] button

- Press and hold the button for multi-session in CD/MP3/WMA/AAC mode.

[RETURN] button

- Press the button to return to the previous mode in some adjust operations.

[◀], [▶] (Search) buttons

- Select a station while in the radio mode or select a track while in CD/MP3/WMA/AAC mode.
- Press and hold the button for (1 sec.) to switch to fast-forward/fast-reverse.

[IR RECEIVER]

- Receiver for remote control unit.
(Operating range: 30° in all directions)

[UP/DOWN] knob

- Select folders while in MP3/WMA/AAC/USB mode.

[VOLUME] knob

- Adjust the volume by turning the knob.

[ADJUST] button

- Press the button to enter the adjust mode.

[OPTION] button

- Press the button to enter the option mode.

[DISPLAY] button

- Press the button to switch the display indication.
- Press and hold the button to scroll the display.

[AUDIO] button

- Press the button to enter the audio adjust mode.

[POWER] button

- Press the button to turn on or off the power.

[CD SLOT]

- CD insertion slot.

[▲] (Eject) button

- Eject a CD when it is loaded into the unit.

[RESET] button

- Press the button when the following symptoms occur.
 - * Nothing happens when buttons are pressed.
 - * Display is not accurate.
 - * The settings will remain in the ROM even if you turn the power off or press the reset button.

4. REMOTE CONTROL

Optional Wired Remote Control Unit Operations

- Following operations are enabled by remote control with the separately sold Wired Remote Control Unit **CMRC5** (shown below), **CMRC6** or **CMRC7**.

Note:

If the remote control is connected with this unit while the power on, please restart this unit again to confirm the normal display.

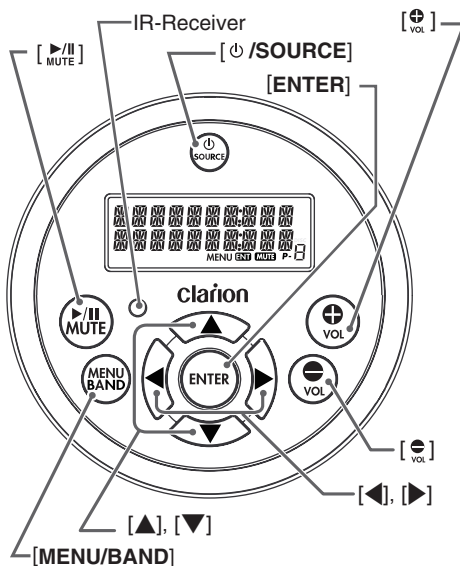

⚠ CAUTION

Lower the volume level before powering the source unit off. The source unit stores the last volume setting.

⚠ WARNING

When the front panel is open, no sound is produced, and source unit controls and remote control unit operations are disabled. Always shut the front panel after changing the CD.

EXPOSING THE UNIT TO WATER WITH THE FRONT PANEL OPEN WILL CAUSE DAMAGE OR UNIT MALFUNCTION!

[⏻/SOURCE] button

- Press the [⏻/SOURCE] button to turn the power on and press and hold it (1 sec.) to turn the power off.
- Each time the [⏻/SOURCE] button is pressed, the mode switches in the following order:
Radio mode → CD/MP3/WMA/AAC mode → USB/iPod mode → CD changer mode → AUX mode → Radio mode.....

Note:

- If the above equipment is not connected, corresponding mode cannot be selected.

[ENTER] button

- Confirm various selections.

[⏪], [⏩] buttons

- Press the [⏪] button to increase the volume.
- Press the [⏩] button to decrease the volume.

[◀], [▶] button

- Press the [▶] button to start playback from the beginning of the following track. Press the [◀] button to start playback from the beginning of the current track. If pressed again, the track moves to the previous one. (in CD changer mode, CD/MP3/WMA/AAC mode or USB/iPod mode)
- Press and hold the [▶] button to fast-forward the disc. Press and hold the [◀] button to fast-reverse the disc.
 - * Pressing and holding the [◀] or [▶] button (1 sec.) will move forward or backward faster than normal play, and pressing and holding it for (3 sec.) will do the operation even faster.

- Press the [◀] or [▶] button to tune in a station for seek tuning or manual tuning (Radio mode only).

[▲], [▼] buttons

- Select preset stations (in Radio mode)
- Select folders (in MP3/WMA/AAC or USB mode)
- Select discs (in CD changer mode)

[MENU/BAND] button

- Each time the button is pressed, the band switches in the following order:
FM1 → FM2 → FM3 → AM → FM1.....
- Press and hold the button (1 sec.) to switch between seek tuning and manual tuning. (in radio mode)
- Press and hold the button, it will start from the first track. (in CD/MP3/WMA/AAC and USB modes)
- Press the button, it will start from the first track of the current disc. (in CD changer mode)
- Press the [MENU] button to enter the list search mode. (in CD/MP3/WMA/AAC and USB modes)

[MUTE] button

- Press the [MUTE] button. The sound is muted immediately. To cancel, press the [MUTE] button again. (in radio and satellite modes)
- Press to play or pause in CD/MP3/WMA/AAC, and CD changer mode.

IR-Receiver

- Receiver for remote control unit. (Operating range: 30° in all directions)

Wireless Remote Control Unit Operations

* Some buttons on the remote control unit have different functions from the corresponding buttons on the main unit.

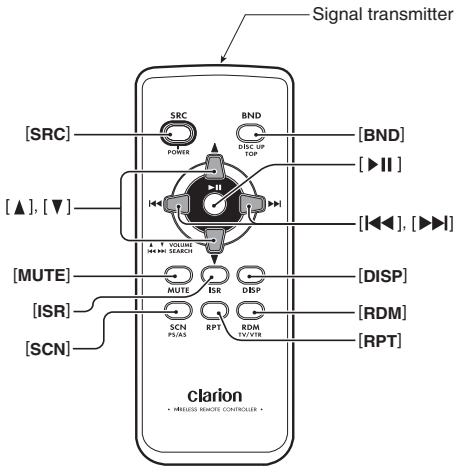

● Shared modes

[SRC] button

- Press the button to turn on the power.
Press and hold the button (1 sec.) to turn off the power.
- Use to alternate operation mode among the various modes.

[▲], [▼] buttons

- Increases and decreases volume.

[MUTE] button

- Turns mute function on and off.

[DISP] button

- Press to select the desired display.

● Radio mode

[BND] button

- Switches reception band.

[◀◀], [▶▶] buttons

- Moves preset channels up and down.

[SCN] button

- Press to perform preset scan.
- Press and hold the button (2 sec.) to perform auto store.

● CD/MP3/WMA/AAC and USB/MTP modes

[BND] button

- Press to play the first track.

[◀◀], [▶▶] buttons

- Press to select tracks.
- Press and hold the button (1 sec.) to perform fast-forward/fast-reverse (Except DRM file).

[▶|] button

- Switches between playback and pause.

[SCN] button

- Press to perform scan play.
- When in MP3/WMA/AAC and USB/MTP modes, press and hold the button (1 sec.) to perform folder scan play.

[RPT] button

- Press to perform repeat play.
- When in MP3/WMA/AAC and USB/MTP modes, press and hold the button (1 sec.) to perform folder repeat play.

[RDM] button

- Press to perform random play.
- When in MP3/WMA/AAC and USB/MTP modes, press and hold the button (1 sec.) to perform folder random play.

Wireless Remote Control Unit Operations

● CD changer mode

[BND] button

- Press and hold to switch to next disc in ascending order.
- Press to play the first track of the current disc.

[◀◀], [▶▶] buttons

- Press to move the tracks up and down.
- Press and hold the button (1 sec.) to perform fast-forward/fast-backward.

[▶||] button

- Switches between playback and pause.

[SCN] button

- Press to perform scan play.
- Press and hold the button (1 sec.) to perform disc scan play.

[RPT] button

- Press to perform repeat play.
- Press and hold the button (1 sec.) to perform disc repeat play.

[RDM] button

- Press to perform random play.
- Press and hold the button (1 sec.) to perform disc random play.

● iPod mode

[◀◀], [▶▶] buttons

- Press to move the tracks up and down.
- Press and hold the button (1 sec.) to perform fast-forward/fast-reverse.

[▶||] button

- Switches between playback and pause.

[RPT] button

- Press to perform repeat play.

[RDM] button

- Press to perform random play.
- Press and hold the button (1 sec.) to perform all random play.

Inserting the Battery

- ① Turn over the remote control unit and slide the cover in the direction indicated by the arrow in the illustration.
- ② Insert the battery (CR2025) into the insertion guides, with the printed side (+) facing upwards.
- ③ Press the battery in the direction indicated by the arrow so that it slides into the compartment.
- ④ Replace the cover and slide in until it clicks into place.

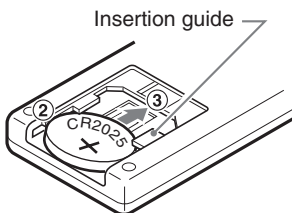
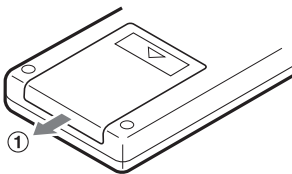

Notes:

Misuse may result in rupture of the battery, producing leakage of fluid and resulting in personal injury or damage to surrounding materials. Always follow these safety precautions:

- Use only the designated battery.
- When replacing the battery, insert properly, with +/- polarities oriented correctly.
- Do not subject battery to heat, or dispose of in fire or water. Do not attempt to disassemble the battery.
- Dispose of used batteries properly.

5. OPERATIONS

Note:

- Be sure to read this chapter referring to the front diagrams of chapter "3. CONTROLS" on page 6.

Basic Operations

⚠ CAUTION

Be sure to lower the volume before powering the source unit off. The unit remembers its last volume setting.

⚠ WARNING

When the front panel is open, no sound is produced, and source unit controls and remote control unit operations are disabled. Always shut the front panel after changing the CD.

EXPOSING THE UNIT TO WATER WITH THE FRONT PANEL OPEN WILL CAUSE DAMAGE OR UNIT MALFUNCTION!

Turning on/off the power

Press the [POWER] button to turn on or off the power.

Note:

- **System check**
The first time this unit is turned on after the wire connections are completed, it must be checked what equipment is connected. When the power is turned on, the "SYSTEM CHECK" appears in the display, then the unit returns to the radio mode.

Selecting a mode

1. Press the [DISC], [AUX/iPod] or [AM/FM] button to change the operation mode.
 - * External equipment not connected with CeNET is not displayed.
 - * iPod/MTP can connect to this unit via USB cable.

Adjusting the volume

1. Turning the [VOLUME] knob clockwise increases the volume; turning it counterclockwise decreases the volume.
 - * The volume level is from 0 (minimum) to 33 (maximum).

Switching the display

Press the [DISPLAY] button to select the desired display.

Audio Adjustment

You can adjust a audio effect or tone quality to your preference.

To change sound setting

1. Press the [AUDIO] button to switch to the sound adjustment selection display.
2. Then press the [◀] or [▶] button to select the audio adjustment mode.

Each time you press the [◀] or [▶] button, the audio adjustment mode changes as following order:

("BBE MP") ↔ "BASS" ↔ "TREBLE" ↔
"BALANCE" ↔ "FADER" ↔ "NO FADER"

- * In the case of display blinking "ENT", you can press the [ENTER] button to adjust the setting value.
 - * "BBE MP" can be selected only in the CD/MP3/WMA/AAC and USB/iPod mode.
3. Turn the [UP/DOWN] knob to adjust the selected audio mode.
 4. After completing settings, press the [RETURN] button to return to the previous mode.

● Setting the BBE MP (Sound Enhancement and Restoration for compressed audio files)

BBE MP (Minimized Polynomial Non-Linear Saturation) Process improves digitally compressed sound, such as MP3, by restoring and enhancing the harmonics lost through compression. BBE MP works by regenerating harmonics from the source material, effectively recovering warmth, detail and nuance.

* This function is effective for the audio files in the CD/MP3/WMA/AAC or USB/iPod mode.

2-1. Select "**BBE MP**".

3-1. Turn the **[UP/DOWN]** knob to select "**ON**" or "**OFF**".

* The factory default setting is "**OFF**".

3-2. When you select "**ON**", press the **[ENTER]** button, then turn the **[UP/DOWN]** knob to select as following order.

LOW ↔ **MID** ↔ **HIGH**

Notes:

- Manufactured under license from BBE Sound, Inc.
- Licensed by BBE Sound, Inc. under one or more of the following US patents: 5510752, 5736897. BBE and BBE symbol are registered trademarks of BBE Sound, Inc.

● Adjusting the bass

2-1. Select "**BASS**".

Turn the **[UP/DOWN]** knob to adjust the gain from -7 to +7 (The factory default setting is "**0**").

● Adjusting the treble

2-1. Select "**TREBLE**".

Turn the **[UP/DOWN]** knob to adjust the gain from -6 to +6 (The factory default setting is "**0**").

● Adjusting the balance

2-1. Select "**BALANCE**".

3-1. Turn the **[UP/DOWN]** knob to adjust the balance of the right and left speakers.

* The factory default setting is "**CENTER**" (center). (Adjustment range: RIGHT12 to LEFT12 (right 12 to left 12))

● Adjusting the fader

2-1. Select "**FADER**".

3-1. Turn the **[UP/DOWN]** knob to adjust the balance of the rear and front speakers.

* The factory default setting is "**CENTER**" (center). (Adjustment range: FRONT12 to REAR12 (front 12 to rear 12))

● Adjusting the non-fader volume

Adjust volume output from the unit's non-fader output terminal.

2-1. Select "**NO FADER**".

3-1. Turn the **[UP/DOWN]** knob clockwise to increase volume; turn counterclockwise to decrease volume.

* The factory default setting is "**0**". (Adjustment range: +6 to -6)

• During **SOUND** adjustment mode, if no operation is performed for more than 10 seconds, this mode can be cancelled and return to previous mode.

Radio Operations

Changing the reception area

This unit is initially set to USA frequency intervals of 10 kHz for AM and 200 kHz for FM. When using it outside the USA, the frequency reception range can be switched to the intervals below.

		U.S. standard	Other countries	Europe standard
AM	Frequency spacing	10 kHz	9 kHz	9 kHz
	Frequency range	530 to 1,710 kHz	531 to 1,629 kHz	531 to 1,602 kHz
FM	Frequency spacing	200 kHz	50 kHz	50 kHz
	Frequency range	87.9 to 107.9 MHz	87.0 to 108 MHz	87.5 to 108 MHz

Setting the reception area

* All station preset memories are lost when the reception area is changed.

1. Press the [AM/FM] button and select the desired radio band (FM or AM).
2. Press the [OPTION] button.
3. Press the [◀] or [▶] button to select "TUN AREA".

• U.S. standard (new setting)

4-1. Turn the [UP/DOWN] knob to select "U".

• Other countries (new setting)

4-2. Turn the [UP/DOWN] knob to select "K".

• Europe standard (initial setting)

4-3. Turn the [UP/DOWN] knob to select "E".

5. Press and hold the [ENTER] button to store the selecting.

Listening to the radio

1. Press the [AM/FM] button and select the radio mode.
2. Press the [AM/FM] button and select the radio band. Each time the button is pressed, the radio reception band changes in the following order:

FM1 → FM2 → FM3 → AM → FM1...

Mute

Use this function to turn off the sound immediately.

1. Press the [MUTE] button. The sound turns off and "MUTE" appears on the display.
2. Press the [MUTE] button again to cancel the mute mode.

Tuning

There are 3 types of tuning mode available, seek tuning, manual tuning and preset tuning.

Seek tuning

1. Press the [AM/FM] button and select the desired band (FM or AM).
2. Press the [◀] or [▶] button to automatically seek a station.

Manual tuning

There are 2 ways available: Quick tuning and step tuning.

* If "MANU" is not lit in the display, press and hold the [AM/FM] button (1 sec.).

● Quick tuning

Press and hold the [◀] or [▶] button (1 sec.) to tune in a station.

● Step tuning

Press the [◀] or [▶] button to manually tune in a station.

Recalling a preset station

A total of 24 preset positions (6-FM1, 6-FM2, 6-FM3, 6-AM) exists to store individual radio stations in memory.

1. Press the [AM/FM] button and select the radio band.
2. Press the [MENU] button.
3. Turn the [UP/DOWN] knob to select the desired preset station.
4. Press the [ENTER] button to recall the stored frequency.

Note:

* After the band selecting, you can also turn the [UP/DOWN] knob to select a desired preset station.

Manual memory

1. Select the desired station with seek tuning or manual tuning.
2. Press the [MENU] button
3. Turn the [UP/DOWN] knob to select a desired station.
4. Press and hold the [ENTER] button to store the current station into preset memory.

Auto store

Auto store is a function for storing up to 6 stations that are automatically tuned in sequentially. If 6 receivable stations cannot be received, a previously stored station remains unoverwritten at the memory position.

1. Press the [**AM/FM**] button and select the desired band (FM or AM).
2. Press the [**OPTION**] button.
3. Press the [**◀**] or [**▶**] button to select “**AUTO STORE**”.
4. Press and hold the [**ENTER**] button for 2 seconds or longer. The stations with good reception are stored automatically to the preset channels.

* If auto store is performed in the FM bands, the stations are stored in FM3 even if FM1 or FM2 was chosen for storing stations.

Preset scan

Preset scan receives the stations stored in preset memory in order. This function is useful when searching for a desired station in memory.

1. Press the [**OPTION**] button.
2. Press the [**◀**] or [**▶**] button to select “**PRESET SCN**”.
3. Press the [**ENTER**] button.

* When a desired station is tuned in, perform step 1-3 again to continue receiving that station.

CD/MP3/WMA/AAC Operations

MP3/WMA/AAC

This unit can play back MP3/WMA/AAC files.

Notes:

- If you play a file with DRM (Digital Rights Management) for WMA remaining ON, no audio is output (The WMA indicator blinks).
- Windows Media™, and the Windows® logo are trademarks, or registered trademarks of Microsoft Corporation in the United States and/or other countries.

● To disable DRM (Digital Rights Management)

1. When using Windows Media Player 9/10/11, click on TOOL → OPTIONS → MUSIC RECORD tab, then under Recording settings, unclick the Check box for RECORD PROTECTED MUSIC. Then, reconstruct files.

Personally constructed WMA files are used at your own responsibility.

Precautions when creating MP3/WMA/AAC file

● Usable sampling rates and bit rates

1. MP3: Sampling rate 8 kHz-48 kHz,
Bit rate 8 kbps-320 kbps / VBR
2. WMA: Bit rate 8 kbps-320 kbps
3. AAC: Sampling rate 8 kHz-48 kHz,
Bit rate 8 kbps-320 kbps / VBR

● File extensions

1. Always add a file extension “.MP3”, “.WMA” or “.M4A” to MP3, WMA or AAC file by using single byte letters. If you add a file extension other than specified or forget to add the file extension, the file cannot be played.
2. Files without MP3/WMA/AAC data will not play.
 - * When VBR files are played, the play time display may differ the play location.
 - * When MP3/WMA/AAC files are played, a little no sound part is caused between tunes.

● Logical format (File system)

1. When writing MP3/WMA/AAC file on a CD-R disc or CD-RW disc, please select “ISO9660 level 1, 2 or JOLIET or Romeo” or APPLE ISO as the writing software format. Normal play may not be possible if the disc is recorded on another format.
2. The folder name and file name can be displayed as the title during MP3/WMA/AAC

play but the title must be within 64 single byte alphabetical letters and numerals (including an extension).

3. Do not affix a name to a file inside a folder having the same name.

● Folder structure

1. A disc with a folder having more than 8 hierarchical levels will be impossible.

● Number of files or folders

1. Up to 255 files can be recognized per folder. Up to 510 files can be played.
2. Tracks are played in the order that they were recorded onto a disc. (Tracks might not always be played in the order displayed on the PC.)
3. Some noise may occur depending on the type of encoder software used while recording.

Set the type of file to be played (multi-session function)

When a single disc holds both normal CD type tracks and MP3/WMA/AAC type tracks, use this command to select which type of track to play.

* Default setting is “CD”.

- When only one type of track (either music CD or MP3/WMA/AAC) is recorded on a disc, selecting either type will allow playback of the disc.
 - When playing CCCC (copy-control CDs), set to CD type.
1. Each time you press and hold the [ENTER] button, the mixed mode is switch between “MULTI-SESS CD” and “MULTI-SESS MP3”.
 - “MULTI-SESS CD”
When playing music CD only.
 - “MULTI-SESS MP3”
When playing music MP3/WMA/AAC only.
 2. When setting is completed, remove the disc and reinsert it.

Backup Eject function

Just pressing the [▲] button, ejects the disc even if the power to the unit was not turned on.

1. Press the [OPEN] button to open the front panel.

Note:

* If the front panel will not open far enough, open it gently with your hand.

CD/MP3/WMA/AAC Operations

2. Press the [▲] button. Remove the disc after it is ejected.

3. Close the front panel.

* Press the center of the DCP to close.

Notes:

- Always close the front panel once you take out the disc.
- If a CD (12 cm) is left in the ejected position for 15 seconds, the CD is automatically reloaded (Auto reload).
- If you force a CD into before auto reloading, this can damage the CD.

CAUTION

- Do not try to put your hand or fingers in the disc insertion slot. Also never insert foreign objects into the slot.
- Do not insert discs where adhesive comes out from cellophane tape or a rental CD label, or discs with marks where cellophane tape or rental CD labels were removed. It may be impossible to extract these discs from the unit and they may cause the unit to break down.

Listening to a disc already loaded in the unit

Press the [DISC] button to select the CD/MP3/WMA/AAC mode.



When the unit enters the CD/MP3/WMA/AAC mode, play starts automatically.

If there is no disc loaded, the indication “NO DISC” appears in the title display.

Loading a CD

1. Press the [OPEN] button to access the CD SLOT behind the front panel.
2. Insert a CD into the center of the CD SLOT with the labeled side facing up. “LOADING” appears in the display, the CD enters into the slot, and the play starts.

Notes:

- Never insert foreign objects into the CD SLOT.
 - If the CD is not inserted easily, there may be another CD in the mechanism or the unit may require service.
 - Discs not bearing the  or  mark and CD-ROMs cannot be played by this unit.
 - Some CDs recorded in CD-R/CD-RW mode may not be usable.
3. Close the front panel.

* Press the center of the DCP to close.

CAUTION

Be careful not to catch your hand or fingers while closing the front panel.

Notes:

- * If the front panel does not open fully, gently open with your hand.
- * After loading a CD, always close the front panel.

Pausing play

1. Press and hold the [MUTE] button to pause play.

“PAUSE” appears in the display.

2. To resume CD play, press and hold the [MUTE] button again.

Displaying CD titles

This unit can display title data for CD-text/MP3/WMA/AAC disc with this unit.

1. Each time you press the [DISPLAY] button to change the title display.

● CD-TEXT disc

Track → Disc/Artist

● MP3/WMA/AAC disc

Track → Folder → Title/Album → Artist

Notes:

- If the CD playing is not a CD-text CD “NO TITLE” appears in the display.
- If MP3/WMA/AAC disc is not input TAG, “NO TITLE” appears in the display.
- For MP3, supports ID3 Tags V2.3 / 2.2 / 1.1 / 1.0.
- Tag displays give priority to V2.3 / 2.2.
- In the case of album Tags for WMA, the information written into the extension header is displayed.
- Only ASCII characters can be displayed in Tags.

Selecting a track

● Track-up

1. Press the [▶] button to move ahead to the beginning of the next track.
2. Each time you press the [▶] button, the track advances ahead to the beginning of the next track.

● Track-down

1. Press the [◀] button to move back to the beginning of the current track.
2. Press the [◀] button twice to move back to the beginning of the previous track.

Fast-forward/fast-reverse

● Fast-forward

1. Press and hold the [▶] button (1 sec.).

● Fast-reverse

1. Press and hold the [◀] button (1 sec.).

* For MP3/WMA/AAC discs, it takes some time until the start of searching and between tracks. In addition, the playing time may have a margin of error.

Folder Select

This function allows you to select a folder containing MP3/WMA/AAC files and start playing from the first track in the folder.

1. Turn the [UP/DOWN] knob to select a folder.
2. To select a track, press the [◀] or [▶] button.

Top function

The top function resets the CD player to the first track of the disc. Press and hold the [MENU] button to play the first track (track No. 1) on the disc.

* In case of MP3/WMA/AAC, the first track of a folder being played will be returned.

List search function

1. Press the [MENU] button to enter the list search mode. And then the track list appears in the display.
2. Turn the [UP/DOWN] knob to select a track.
 - * If you press the [◀] or [▶] button, the track list scroll 5 lines at a time.
3. Press the [ENTER] button to play.
 - * In case of MP3/WMA/AAC, this function is performed in the current folder.

Note:

- If no operation is performed for more than 10 seconds, this mode can be cancel and return to the usual mode.

Other various play functions

1. Press the [OPTION] button.

● Scan play

This function allows you to locate and play the first 10 seconds of all the tracks recorded on a disc.

2. Press the [◀] or [▶] button to select "SCN".
3. Turn the [UP/DOWN] knob to select "TRACK".
4. Press the [ENTER] button.

● Folder scan play

This function allows you to locate and play the first 10 seconds of the first track of all the folders on an MP3/WMA/AAC disc.

2. Press the [◀] or [▶] button to select "SCN".
3. Turn the [UP/DOWN] knob to select "ALL".
4. Press the [ENTER] button.

● Repeat play

This function allows you to play the current track repeatedly.

2. Press the [◀] or [▶] button to select "RPT".
3. Turn the [UP/DOWN] knob to select "TRACK".
4. Press the [ENTER] button.

● Folder repeat play

This function allows you to play a track currently being played in the MP3/WMA/AAC folder repeatedly.

2. Press the [◀] or [▶] button to select "RPT".
3. Turn the [UP/DOWN] knob to select "ALL".
4. Press the [ENTER] button.

● Random play

This function allows you to play all tracks recorded on a disc in a random order.

2. Press the [◀] or [▶] button to select "RDM".
3. Turn the [UP/DOWN] knob to select "TRACK".
4. Press the [ENTER] button.

● Folder random play

This function allows you to play all the tracks of all the folders recorded on an MP3/WMA/AAC disc in a random order.

2. Press the [◀] or [▶] button to select "RDM".
3. Turn the [UP/DOWN] knob to select "ALL".
4. Press the [ENTER] button.

● To cancel play

2. Press the [◀] or [▶] button to select "TRICK PLAY OFF".
3. Press the [ENTER] button.

Operations Common to Each Mode

To change adjustment setting

1. Press the [**ADJUST**] button to switch to the adjustment selection display.
2. Press the [**◀**] or [**▶**] button to select the "item name".
 "CLOCK" ↔ "CONTRAST" ↔
 "SETTINGS" ↔ "SCROLL" ↔
 "DIMMER" ↔ "TEL-SP" ↔ "TEL-SW" ↔
 "RESET" ↔ "SYSTEM CHECK"
3. Turn the [**UP/DOWN**] knob to select the "desired setting value".
 * In the case of display blinking "ENT", you can press the [**ENT**] button to adjust the setting value.
4. After completing settings, press the [**ADJUST**] or [**RETURN**] button to return to the previous mode.

● Setting the clock

- 2-1. Select "CLOCK".
- 3-1. Press the [**ENTER**] button.
- 3-2. Press the [**◀**] or [**▶**] button to select the hour or the minute.
- 3-3. Turn the [**UP/DOWN**] knob to set the correct time.
 * The clock is displayed in 12-hour format.
- 3-4. Press the [**ENTER**] button to store the time into memory.

Note:

- You cannot set the clock when it is displayed with only the ignition on. If you drain or remove the boat's battery or take out this unit, the clock is reset. While setting the clock, if another button or operation is selected, the clock set mode is canceled.

● Setting the contrast

You can adjust the display contrast to match the angle of installation of the unit.

- * The factory default setting is "9".
(Adjustment level: 1 to 10)
- 2-1. Select "CONTRAST".
 - 3-1. Turn the [**UP/DOWN**] knob to adjust the contrast.

● Displaying the settings

The number of indicator of this unit decreases, you can see the state of current settings at any operation mode.

- 2-1. Select "SETTINGS".
- 3-1. Turn the [**UP/DOWN**] knob to display the state of current settings.
 * When the setting is selected, after 1 second the current state will be displayed.

For example:

after 1 second,

● Setting the method for title scroll

Set how to scroll in CD-TEXT, MP3/WMA/AAC title.

- * The factory default setting is "ON".
- 2-1. Select "SCROLL".
 - 3-1. Turn the [**UP/DOWN**] knob to select "ON" or "OFF".

• ON:

To scroll automatically.

• OFF:

To scroll just 1 time.

- * When you want to see the title again, in the title mode, press and hold the [**DISPLAY**] button for 3 seconds or longer to scroll the title.

● Setting the dimmer control

You can set the dimmer control "ON" or "OFF".

- * The factory default setting is "ON".
- 2-1. Select "DIMMER".
 - 3-1. Turn the [**UP/DOWN**] knob to select "ON" or "OFF".

● Setting the speaker output for cell phones

When the rear AUX1 input terminals are used to connect an AUX BLUETOOTH BB (BLT370) (sold separately):

- * The factory default setting is "RIGHT".
- * To output the telephone calls, set cell phone interrupt to "ON".

- 2-1. Select "TEL-SP".
- 3-1. Turn the [**UP/DOWN**] knob to select "RIGHT" or "LEFT".

- **RIGHT:** Telephone calls can be heard on the front right speaker connected to this unit.

Operations Common to Each Mode

- **LEFT:** Telephone calls can be heard on the front left speaker connected to this unit.

● Cell phone interrupt setting

If you connect this unit and your cell phone with an optional cable, you can listen to your calls on your speakers.

When the rear AUX1 input terminals are used to connect an AUX BLUETOOTH BB (BLT370) (sold separately):

* The factory default setting is “OFF”.

2-1. Select “TEL-SW”.

3-1. Turn the [UP/DOWN] knob to select setting. When turning the [UP/DOWN] knob, the setting changes as follows:

“OFF” ↔ “ON” ↔ “MUTE”

- **OFF:** This unit continues normal operation even when the cell phone is used.
- **ON:** Telephone calls can be heard from the speakers connected to the unit.
- * When listening to calls on your speakers, turn the [VOLUME] knob to adjust the volume.
- **MUTE:** The sound from this unit is muted during telephone calls.

Note:

- If connecting a hands-free kit, make sure the setting is ON to receive telephone audio through the system.

● Performing memory reset

This function allows you to reset adjusted settings in the ROM.

The stored settings like preset channels, password adjusted areas, adjust mode settings and audio mode settings can be formatted by this function.

Note:

- The settings will remain in the ROM even if you turn the power off or press the reset button.

2-1. Select “RESET”.

3-1. Press and hold the [ENTER] button.

This unit will be restarted automatically.

● Performing a system check

This function allows you to perform a system check from the adjust mode when required.

2-1. Select “SYSTEM CHECK”.

3-1. Press and hold the [ENTER] button (1 sec.).

“SYSTEM CHECK” appears in the display, then the unit returns to the previous operation mode.

AUX function

The rear AUX terminals of this system is provided to allow playback of sounds and music from external devices connected to this unit.

● Selecting AUX mode

1. Press the [AUX/iPod] button to select “AUX 1” or “AUX 2”.

● Selecting AUX IN sensitivity

Make the following settings to select the sensitivity when sounds from external devices connected to this unit are difficult to hear even after adjusting the volume.

* The factory default setting is “MID”.

1. Press the [OPTION] button.

2. “AUX SENS” appears in the display.

3. Turn the [UP/DOWN] knob to select “HIGH”, “MID” or “LOW”.

Note:

- When AUX mode is selected, AUX IN sensitivity can be set.

6. ACCESSORIES

USB/MTP Operations

USB memory/MTP device operation

Note:

- The following operations are the same as for CD mode:
 - *Pause
 - *Track selection
 - *Fast-forward/fast-backward (Except DRM file)
 - *Top function
 - *List search
 - *Scan play
 - *Repeat play
 - *Random play
 - *Folder selection

See “CD/MP3/WMA/AAC Operations” (page 16-18) for details.

About USB memory

- USB is an acronym for Universal Serial Bus, and refers to an external bus standard supporting data transfer rates of 12 Mbps.
- This unit is compatible with USB 1.1/2.0 with maximum data transfer rates of 12 Mbps.
- USB memory devices that can be played by connecting to the unit’s USB cable are limited to those recognized as “USB mass storage class devices”; operation is not guaranteed with all USB memory devices.
 - * Devices compatible with “USB Mass Storage Class” can be used merely by connecting to the host device, without need for special drivers or application software.
- Consult the manufacturer of your USB memory device for information regarding whether it is supported by “USB Mass Storage Class” standards.
- Audio files playable on this unit are limited to MP3/WMA/AAC files. For details, see the section “MP3/WMA/AAC” (page 16). Copy-protected WMA/AAC files cannot be played on this unit.
- The Podcast files of iTunes Store that stored in the USB memory device can not be played. Besides, the data that edit through some softs such as the Tag edit soft may not be played.
- To prevent the accidental loss of data, always back up important data on your computer.
- This unit does not support connections to a computer. In addition, connections made

through a USB hub device are also not supported.

- When a USB memory device is composed of two or more drives, only one of the drives will be detected.
- USB memory devices with security functions cannot be played.
- The order in which tracks are recorded may differ depending on the USB memory device connected (the actual playback order may not be the same as that indicated on your computer’s display).
- If you continuously operate folder up/down, the play time keeps as “00:00”, and the sound is not emitted.

About USB Digital Media Streaming

This unit supports USB Digital Media Streaming. USB Digital Media Streaming is a function used to play music files transmitted using Media Transfer Protocol (MTP). This function also supports the playback of WMDRM 10 files.

During USB Digital Media Streaming, the unit displays the “MTP” mode.

Use of USB Digital Media Streaming requires the purchase of a supported portable audio player. For information regarding supported portable audio players, consult your nearest Clarion dealer, or visit Clarion’s website.

⚠ CAUTION

- **Insert and remove a USB memory/MTP device only when the device is not being accessed. Connecting or disconnecting the device at the following times may result in the loss of data:**
 - If the USB memory/MTP device is removed or power is disconnected during writing to the device.
 - When the device is subjected to static electricity or electric noise.
- **Do not leave a USB memory/MTP device unattended in a boat. Exposure to direct sunlight or high temperatures may cause deformation or other malfunction of the USB memory/MTP device.**

USB/MTP Operations

- Do not turn on the engine when the MTP device is connected, since it may result in loss or damage to data on the MTP device. Connect the MTP device to the USB cable after the engine is turned on.

Connecting a USB memory/MTP device

1. Connect the USB memory/MTP device to the USB cable.

Playback will begin from the first file recorded on the device.

- * If the device is not recognized, press the [AUX/iPod] button to switch the source to the device.
- * Always insert the device fully into the connector. Incomplete connections may cause the device not to be recognized.
- * Depending on the number of tracks recorded, some amount of time may be required until all tracks are read into the unit.
- * The order in which tracks are recorded may differ depending on the device connected (the actual playback order may not be the same as that indicated on your computer's display).

To listen to tracks on a connected USB memory/MTP device

1. Press the [AUX/iPod] button to switch the source. When USB memory/MTP device is selected, playback (except DRM files) will begin from the location at which playback was previously stopped.
 - * When a USB memory/MTP device is connected the USB/MTP mode will be displayed.
 - * When a USB memory/MTP device is disconnected and then reconnected, playback will begin from the previous position of the USB memory/MTP device.
 - * When "MTP" mode is selected, AAC files on the MTP device cannot be played.

To stop play

1. Press the [DISC] or [AUX/iPod] button and switch the function to a source other than the USB memory.

CAUTION

Do not remove the USB memory/MTP device when the USB/MTP mode is selected, since it may result in loss or damage to data on the USB memory/MTP device.

Always backup and save important data on your computer.

2. Remove the USB memory/MTP device from the USB cable.

iPod Operations

This section describes operations when connected to an Apple iPod via the USB cable.

Notes:

- See the *iPod Owner's Manual* for details regarding operation conditions.
- The unit will not operate, or may operate improperly with unsupported versions.
- For a list of compatible Apple iPod unit with the this model, please contact your Clarion dealer or www.clarion.com.
- "Made for iPod" means that an electronic accessory has been designed to connect specifically to iPod and has been certified by the developer to meet Apple performance standards.
Apple is not responsible for the operation of this device or its compliance with safety and regulatory standards.
iPod and iTunes are trademarks of Apple Inc., registered in the U.S. and other countries.

Connecting an iPod

When an iPod is connected to the USB slot, "Shuffle" set on the iPod will become as follows:

- "Shuffle (Albums)" play → Random play
- "Shuffle (Songs)" play → All random play

The iPod has two modes, the "Play mode" and the "iPod menu mode" for selecting tracks. Switch between these modes by pressing the [MENU] button.

Note:

- To connect iPod, please use the USB cable attached in iPod.

Select iPod mode

1. Press the [AUX/iPod] button.

Playback will begin from the last file that was played on the iPod.

Notes:

- The following operations in Play mode operate the same as in CD mode:
 - *Track selection: [◀], [▶]
 - *Fast-forward/fast-reverse: [◀◀], [▶▶]
 - *Pause: [⏸/MUTE]
 See "CD/MP3/WMA/AAC Operations" (page 16-18) for details.
- After a Podcast file has completed playback, the pause display, or the track-end position Play-Time display will appear. At that time, select a music file once again.

Setting iPod simple mode

Use this function if you wish to operate through your iPod connected to this unit via the USB cable.

* The factory default setting is "OFF".

1. Press and hold the [OPTION] button.
2. Press [◀] or [▶] to select "S-CTRL".
3. Press the [ENTER] button.
4. Turn the [UP/DOWN] knob to select "ON" or "OFF".
 - **ON:** Operations are made through your iPod.
 - **OFF:** Operations cannot be made through your iPod.
5. Press and hold the [ENTER] button (1 sec.) to store the setting and return to the previous mode.

Notes:

- When performing iPod operations using simple control mode, make the operations slowly. If repetitive operations are performed too quickly, unforeseen errors may occur.
- When performing iPod operations using simple control mode, please do not operate the iPod and the unit at the same time, otherwise there may be unexpected event happened.
- Some iPod models do not support this function. Consult your nearest Clarion dealer or website to confirm which models do not support this function.

Other various play functions (in Play mode)

Notes:

- These functions are not supported when in the iPod menu mode.
- The Repeat function set on the iPod remains the same after attachment/detachment of the iPod.
- The Repeat function on the iPod will be changed when you connect/disconnect the iPod to the unit.

1. Press the [OPTION] button.

● Repeat play

Play back one track repeatedly.

2. Press the [◀] or [▶] button to select "RPT".
3. Press the [ENTER] button.

● Random play

Play all albums within a selected category, in random order. (Corresponds to "Shuffle (Albums)" command on iPod.)

2. Press the [◀] or [▶] button to select "RDM".

iPod Operations

- Turn the [UP/DOWN] knob to select “ALBUM”.
- Press the [ENTER] button.

● All random play

Play all tracks within a selected category, in random order. (Corresponds to “Shuffle (Songs)” command on iPod.)

- Press the [◀] or [▶] button to select “RDM”.
- Turn the [UP/DOWN] knob to select “ALL”.
- Press the [ENTER] button

● To cancel play

- Press the same play button once again.

Notes:

- When the repeat play mode is canceled, after play all tracks within a selected category, playback will begin from the first track in the selected category.
- When playing the last track within a selected category in Random mode, if ACC is switched off then on again, playback will begin from a different track.
- Though the default setting of an iPod is “All Repeat”, the indication on the mode status is not displayed.
- When performing operations using simple control mode, do not set the repeat off on the iPod.

Selecting category from the iPod menu

- Press and hold the [MENU] button to select the iPod menu mode.

The iPod menu categories will be displayed.

Notes:

- Repeat and Random mode operations are not supported when in the iPod menu mode.
- In iPod menu mode, if you press the [◀]/[▶] or turn the [UP/DOWN] knob fast, playback may not be performed.

- Turn the [UP/DOWN] knob to switch between categories.

The iPod menu categories alternate in the following order:

“PLAYLISTS” ↔ “ARTISTS” ↔ “ALBUMS”
 ↔ “SONGS” ↔ “GENRES” ↔
 “COMPOSERS”...

Note:

The iPod menu mode can be canceled by performing one of the following operations:

- Press the [MENU] button.
 - When the category select screen is displayed, press the [RETURN] button.
- Press the [▶] button to select the category.

* Subfolders may be displayed, depending on the category.

In this case, turn the [UP/DOWN] knob to switch between subfolders, then use the [▶] button to select the desired subfolder.

- Turn the [UP/DOWN] knob to select a track within a category.

* When the track name display is showing, pressing the [◀] button will return to the currently playing folder name display.

- Press the [▶] or [ENTER] button to play.

iPod menu alphabet search

This function searches the subfolders for desired alphabetical letters.

- Press and hold the [MENU] button to select the iPod menu mode.
- Turn the [UP/DOWN] knob to switch between categories.
- Press the [▶] button.

* Subfolders may be displayed, depending on the category. In this case, you can turn the [UP/DOWN] knob to switch between subfolders and use the [▶] button to enter the next subfolder layer.

- Press and hold the [DISPLAY] button (1 sec.).
- Turn the [UP/DOWN] knob to select the desired letter to search.
- Press the [DISPLAY] button to perform search.

iPod menu list back

In the iPod menu operation mode:

If press the [MENU] button, it will return to the previous subfolder list mode.

If press and hold the [MENU] button (1 sec.), it will return to the category list mode.

About title display

This unit supports the display of title information transmitted from a connected iPod.

- Character code information is UTF-8; displayable characters include English alphanumeric, some symbols, and some umlaut characters.
- Unsupported characters will be replaced by asterisks (*).

CD Changer Operations

Note:

- The following operations are the same as for CD mode:

*Pause

*Track selection

*Fast-forward/fast-reverse

*Scan play

*Repeat play

*Random play

See “**CD/MP3/WMA/AAC Operations**” (page 16-18) for details.

CD changer functions

When an optional CD changer is connected through the CeNET cable, this unit controls all CD changer functions. This unit can control a total of 2 changers.

Press the [DISC] button and select the CD changer mode to start play. If 2 CD changers are connected, press the [DISC] button to select the CD changer for play.

- * If “**NO MAG**” appears in the display, insert the magazine into the CD changer. “**D-CHECK**” appears in the display while the player loads (checks) the magazine.
- * If “**NO DISC**” appears in the display, eject the magazine and insert discs into each slot. Then, reinsert the magazine back into the CD changer.

Note:

- Some CDs recorded in CD-R/CD-RW mode may not be usable.

CAUTION

CD-ROM discs cannot be played from every CD changer, it's depended on the model.

Displaying CD titles

This unit can display title data for CD-text CDs with this unit.

- * Title data for CD-text CDs can be displayed with this unit only when it is connected to DCZ625.

1. Press the [DISPLAY] button to change the title display.

Notes:

- If the CD playing is not a CD-text CD or no user title has been input, “**NO TITLE**” appears in the display.
- If a CD-text CD is not input its disc title or a track title, “**NO TITLE**” appears in the display.

Procedure to scroll a title

Set “**SCROLL**” to “**ON**” or “**OFF**”.

(The factory default setting is “**ON**”. Refer to the subsection “**Setting the method for title scroll**” in section “**Operations Common to Each Mode**”.)

● When set to “ON”

The title is automatically kept scrolling.

● When set to “OFF”

To scroll just 1 time.

When you want to see the title again, in the title mode, press and hold the [DISPLAY] button (3 sec.) to scroll the title.

Selecting a CD

1. Turn the [UP/DOWN] knob to select the desired disc.

- * If a CD is not loaded in a slot of magazine, turn the [UP/DOWN] knob can not work.

Other various play functions

1. Press the [OPTION] button.

● Disc scan play

Disc scan play locates and plays the first 10 seconds of the first track on each disc in the currently selected CD changer. This function continues automatically until it is cancelled.

- * Disc scan play is useful when you want to select a desired CD.

2. Press the [◀] or [▶] button to select “**SCN**”.
3. Turn the [UP/DOWN] knob to select “**ALL**”.
4. Press the [ENTER] button.

● Disc repeat play

After all the tracks on the current disc have been played, disc repeat play automatically replays the current disc over from the first track. This function continues automatically until it is cancelled.

2. Press the [◀] or [▶] button to select “**RPT**”.
3. Turn the [UP/DOWN] knob to select “**ALL**”.
4. Press the [ENTER] button.

● Disc random play

The disc random play selects and plays individual tracks or discs automatically in no particular order. This function continues automatically until it is cancelled.

2. Press the [◀] or [▶] button to select “**RDM**”.
3. Turn the [UP/DOWN] knob to select “**ALL**”.
4. Press the [ENTER] button.

● To cancel play

2. Press the [◀] or [▶] button to select “**TRICK PLAY OFF**”.
3. Press the [ENTER] button.

7. TROUBLESHOOTING

	Problem	Cause	Measure	
General	Power does not turn on. (No sound is produced.)	Fuse is blown.	Replace with a fuse of the same amperage. If the fuse blows again, consult your store of purchase.	
		Incorrect wiring.	Consult your store of purchase.	
	No sound output when operating the unit with amplifiers.	Amplifier turn-on lead is shorted to ground or excessive current is required.	Turn the unit off and check each wire for a possible short. If the amplifier turn-on lead shorts out, cover it with insulation such as tape.	
	Nothing happens when buttons are pressed. Display is not accurate.	The microprocessor has malfunctioned due to noise, etc.	Turn off the power, then press the [OPEN] button and remove the DCP. Press the reset button for about 2 seconds with a thin rod. If the RESET button is pressed when a disc is loaded, please eject the disc and load it once again before attempting to play it.	
			DCP or main unit connectors are dirty.	
	No sound heard	The speaker protection circuit is operating.	<ol style="list-style-type: none"> 1. Turn down sound volume. Function can also be restored by turning the power off and on again. (Speaker volume is reduced automatically when the speaker protection circuit operates). 2. If the sound is muted again, consult our service department. 	

	Problem	Cause	Measure
CD/MP3/WMA/AAC	No sound heard	MP3/WMA/AAC files are absent in a disc.	Write MP3/WMA/AAC files onto the disc properly.
		Files are not recognized as an MP3/WMA/AAC file.	Use MP3/WMA/AAC files encoded properly.
		File system is not correct.	Use ISO9660 level 1, 2 or JOLIET or Romeo or APPLE ISO file system.
	Sound skips or is noisy.	Compact disc is dirty.	Clean the compact disc with a soft cloth.
		Compact disc is heavily scratched or warped.	Replace with a compact disc with no scratches.
	Sound is cut or skipped. Noise is generated or noise is mixed with sound.	MP3/WMA/AAC files are not encoded properly.	Use MP3/WMA/AAC files encoded properly.
	Sound is bad directly after power is turned on.	Water droplets may form on the internal lens in a humid place.	Let dry for about 1 hour with the power on.
Wrong filename	File system is not correct.	Use ISO9660 level 1, 2 or JOLIET or Romeo or APPLE ISO file system.	
USB/MTP/iPod	No sound heard	The device contains no MP3/WMA/AAC files.	Record MP3/WMA/AAC files properly to the device.
		The files are not proper MP3/WMA/AAC format.	Use only properly encoded MP3/WMA/AAC files.
		Connectors are loose.	Disconnect the device and reconnect securely.
		Some USB portable music players may consume current that exceeds the USB rating. In this case, this unit's overcurrent protection circuit operates to stop the music playback.	Check operation of portable music player.
	Sound is interrupted or has noise.	The MP3/WMA/AAC files are improperly encoded.	Use only properly encoded MP3/WMA/AAC files.
	The device isn't recognized.	The device is damaged.	Disconnect the device and reconnect. If the device is still not recognized, try replacing with a different device.
		Connectors are loose.	
		According to the state of operation on the device, the communication fault is caused.	Disconnect the device and reconnect.
Can't insert the device.	The device has been inserted improperly.	Try reversing the connection direction of the device (usually the brand name surface should be facing left).	
	The connector is broken.	Replace with a new device.	

8. ERROR DISPLAYS

If an error occurs, one of the following displays is displayed.

Take the measures described below to eliminate the problem.

	Error Display	Cause	Measure
CD/MP3/WMA/AAC	ERROR 2	A CD is caught inside the CD deck and is not ejected.	This is a failure of CD deck's mechanism and consult your store of purchase.
	ERROR 3	A CD cannot be played due to scratches, etc.	Replace with a non-scratched, non-warped-disc.
	ERROR 6	A CD is loaded upside-down inside the CD deck and does not play.	Eject the disc then reload it properly.
CD changer	ERROR 2	A CD inside the CD changer is not loaded.	This is a failure of CD changer's mechanism and consult your store of purchase.
	ERROR 3	A CD inside the CD changer cannot be played due to scratches, etc.	Replace with a non-scratched, non-warped disc.
	ERROR 6	A CD inside the CD changer cannot be played because it is loaded upside-down.	Eject the disc then reload it properly.
USB/MTP/iPod	ERROR 2	The files are not proper MP3/WMA/AAC format.	Use only properly encoded MP3/WMA/AAC files.
	ERROR 3 (USB/MTP mode)	The MP3/WMA/AAC files are improperly encoded.	Use only properly encoded MP3/WMA/AAC files.
	CUR ERR	Overcurrent detection.	Disconnect the devices and reconnect. If the devices are still not recognized, try replacing with a different devices.
	HUB ERR	Do not support the HUB devices.	Do not use the HUB devices.

If an error display other than the ones described above appears, press the reset button. If the problem persists, turn off the power and consult your store of purchase.

9. SPECIFICATIONS

FM Tuner

Frequency Range:

USA: 87.9 MHz to 107.9 MHz

Europe: 87.5 MHz to 108.0 MHz

Australia: 87.0 MHz to 108.0 MHz

Usable Sensitivity: 11 dB μ V

50dB Quieting Sensitivity: 17 dB μ V

Alternate Channel Selectivity: 60 dB

Stereo Separation (1 kHz): 30 dB

Frequency Response (± 3 dB): 30 Hz to 15 kHz

AM Tuner

Frequency Range:

USA: 530 kHz to 1710 kHz

Europe: 531 kHz to 1602 kHz

Australia: 531 kHz to 1629 kHz

Usable Sensitivity: 28 dB μ V

CD Player

System: Compact disc digital audio system

Usable Discs: Compact disc

Frequency Response (± 1 dB): 20 Hz to 20 kHz

Dynamic Range (1 kHz): 80 dB

Harmonic Distortion: 0.03%

Audio

Maximum Power Output: 200 W (50 W \times 4 ch)

Bass Control Action (100 Hz): +14 dB, -14 dB

Treble Control Action (10 kHz): +12 dB, -12 dB

Line Output Level (CD 1 kHz): 2 V

Note:

- Specifications and design are subject to change without notice for further improvement.

General

Power Supply Voltage:

14.4 V DC (10.8 to 15.6 V allowable), negative ground

Current Consumption: Less than 15 A

Speaker Impedance: 4 Ω (4 Ω to 8 Ω allowable)

Weight / Source unit: 4.56 lb. (2.07 kg)

Weight / Remote control unit:

1.41 oz. (40 g) (including battery)

Dimensions / Source unit:

7-1/8" (Width) \times 2" (Height) \times 7-7/10" (Depth)

[180.4 (W) \times 51.2 (H) \times 195.5 (D) mm]

Dimensions / Remote control unit:

1-3/4" (Width) \times 4-5/16" (Height) \times 7/16" (Depth)

[44 (W) \times 113 (H) \times 11 (D) mm]

Escutcheon section:

7-25/32" (Width) \times 3-19/32" (Height) \times

1-27/32"

(Depth) [198 (W) \times 91 (H) \times 46.8 (D) mm]

10. OTHERS

WMDRM 10 for devices

- This product is protected by certain intellectual property rights of Microsoft. Use or distribution of such technology outside of this product is prohibited without a license from Microsoft.
- Content owners use Windows Media digital rights management technology (WMDRM) to protect their intellectual property, including copyrights. This device uses WMDRM software to access WMDRM-protected content. If the WMDRM software fails to protect the content, content owners may ask Microsoft to revoke the software's ability to use WMDRM to play or copy protected content. Revocation does not affect unprotected content. When you download licenses for protected content, you agree that Microsoft may include a revocation list with the licenses. Content owners may require you to upgrade WMDRM to access their content. If you decline an upgrade, you will not be able to access content that requires the upgrade.

Clarion Co., Ltd.

2009/03

All Rights Reserved. Copyright © 2009: Clarion Co., Ltd.
Printed in Philippines / Imprimé aux Philippines /
Impreso en Filipinas / Stampato nelle Filippine /
Gedruckt auf den Philippinen

PE-3259E
280-8807-00