

Clarion

Clarion Europa GmbH
Hessenring 19-21,
64546 Mörfelden-Walldorf,
Germany
Tel.: +49-6105-977-0
Fax.: +49-6105-977-399

Clarion Europe S.A.S.
244 rue du Pré à Varois
54670 Custines, France
Tel.: +33 3 83 49 44 00
Fax.: +33 3 83 24 17 62

Clarion (G.B.) Ltd.
Unit 5C, Interface Business Park
Bincknoll Lane
Royal Wootton Bassett
Wiltshire, SN4 8QQ, United Kingdom
Tel.: +44 (0) 1793 859560
Fax.: +44 (0) 1793 859598

Clarion Leads the World in Full Digital Sound

Full Digital Sound

Notes

- "Made for iPhone" and "Made for iPad" mean that an electronic accessory has been designed to connect specifically to iPhone or iPad respectively, and has been certified by the developer to meet Apple performance standards. Apple is not responsible for the operation of this device or its compliance with safety and regulatory standards. Please note that the use of this accessory with iPhone or iPad may affect wireless performance. iPhone, iPad and Lightning are trademarks of Apple Inc., registered in the U.S. and other countries. iPad Air and iPad mini are trademarks of Apple Inc. App Store is a service mark of Apple Inc., registered in the U.S. and other countries. IOS is a trademark or registered trademark of Cisco in the U.S. and other countries and is used under license.
- Android™ is a trademark of Google Inc.
- Specification and design are subject to change without notice.
- Photos are non-binding. The manufacturer and importer do not take responsibility for any printing errors.
- Please see the Clarion website for iPod models that can be connected.
- Smartphone compatibility may vary by model and operating system.
- SHARC and the SHARC logo are registered trademarks of Analog Devices, Inc.

Dnote *Trigence Semiconductor's Dnote technology is used for digital signal processing.
Dnote is a registered trademark of Trigence Semiconductor, Inc.



For more information about Full Digital Sound

clarion

moves you ■ connects you

www.clarion.com

See your Clarion dealer for more information.



Scaling the Summit of Full Digital Sound to Shake Up Your Emotions

Full Digital Sound



On the journey to the digital era where different styles of enjoying music abound, an unprecedented Full Digital Sound system that moves and excites the listener was born. This innovative stroke of Digital-to-Digital technology delivers the ultimate in fidelity to render sounds exactly as they were meant to be heard. Each breath of a vocalist, and each vibration of a musical instrument, is reproduced with extreme realism through high-transparency high-response sound. Experience the yet unknown domains and new emotions that Clarion will open up through Full Digital Sound.

Clarion Breakthroughs Leading to New Eras in Car Audio

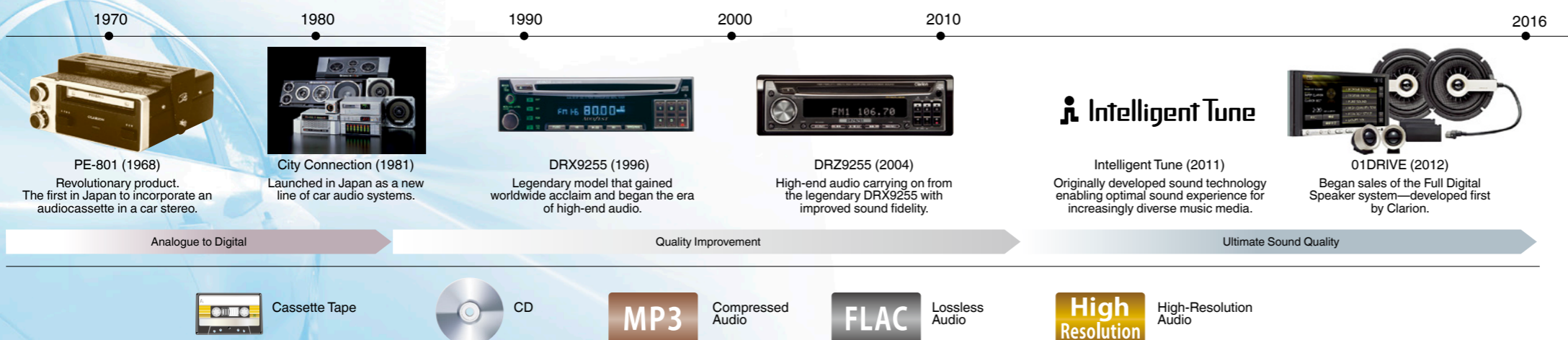

Full Digital Sound

World's First* dedicated LSI for automotive grade Clarion originally developed

Advent of Full Digital Sound First system with all speaker units equipped with new dedicated automotive grade LSI.

* As of September 2015 (Clarion research)

Z3
Full Digital Sound Processor (Sound Processor/Tweeter /Commander)

Z7
Full Digital Speaker

Z25W
Full Digital Subwoofer

Clarion's Full Digital Technology Revolutionizes the Realm of Car Audio

Digital-to-Digital from Source to Speakers, Clarion's Revolution is Pure and Simple

Full Digital Sound achieves full digital signal transfer from the digital source to the speakers for direct input of high-resolution audio sources without sound degradation. Furthermore since it efficiently converts digital signals to sound, the system is capable of delivering 4 times the power output of a conventional full digital system*¹, while achieving power consumption that's only about 1/5th that of analogue systems*².

*¹ Compared to other Clarion references. (Conventional full digital systems were only sold in the Japanese market.) *² Compared to the drive circuit of a typical factory original audio system.

● Conventional System



● Full Digital Sound System



System connectivity

Clearly Reproducing All the Emotion in the Source

Versatility to Connect to Many External Audio Sources

In addition to offering connectivity with our centre unit, the system also supports connection with third party aftermarket centre units and external audio devices. And by simply connecting a smartphone or tablet via USB cable, playback of music on those devices also becomes possible.

Connectors: USB, Digital input (Optical), Digital input (Coaxial), RCA input, Speaker Level input

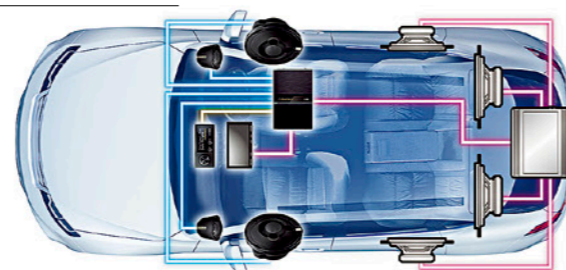

Digital + Analogue mixed system

Revolutionary Technology

Creating the Sound of a New Era, Filled with Expectations

Clarion Develops the World's First*³ Dedicated Automotive Grade LSI Optimised for Full Digital Speaker Drive

Clarion developed the world's first dedicated LSI for digital speakers to lead the way in automotive grade usage. It succeeded in offering higher output power compared to conventional LSI*⁴ while maintaining high-quality performance in severe temperature conditions. Moreover, one-chip high-speed drive (24.5MHz) makes it possible to accommodate high-resolution audio sources.

*³ As of September 2015, Clarion research.
*⁴ Compared to other Clarion references. (Conventional full digital systems were only sold in the Japanese market.)



Sound technology

Orchestrate Your Ideal Sound, Just Like a Conductor

Intuitive Tuning using your Smartphone or Tablet

By installing an application on your smartphone or tablet, you can intuitively operate high-precision tuning, including Crossover, Time Alignment, and Equaliser. Even fine tuning can be done with a few simple steps.



Tuning application enables intuitive operation



Supports Playback of High-Resolution Audio Sources

You can use the USB host cable (OTG cable) to connect to a smartphone or tablet and enjoy playback of high-resolution audio content and other music files stored on your smartphone or tablet with digital-to-digital quality. Full Digital Sound reproduces all the fine nuances and presence of high-resolution audio sources.



Enjoy playing and experiencing high-resolution audio files stored on your smartphone.

Clarion's Full Digital Sound Brings the Uncompromising Sound of the Future to Everyone

The High Quality that Full Digital Sound system Delivers

Extremely High-Resolution

Development of the dedicated LSI for automotive grade enabled Clarion to combine direct digital signal input for 96kHz sampling with 256-times oversampling to achieve the world's first*1 24.5MHz high-output, high-velocity drive. This enables unprecedented high-resolution sound reproduction.

*1 Used as multi-drive D-class driver for automotive grade use

● Resolution comparison of D-class power amplifier and Full Digital Sound

Drive system	Operating frequency
D-class power amplifier	0.2~0.8MHz
Full Digital Sound	24.5MHz

The wave form has higher resolution and is more faithful to the original source wave than a D-class power amplifier.

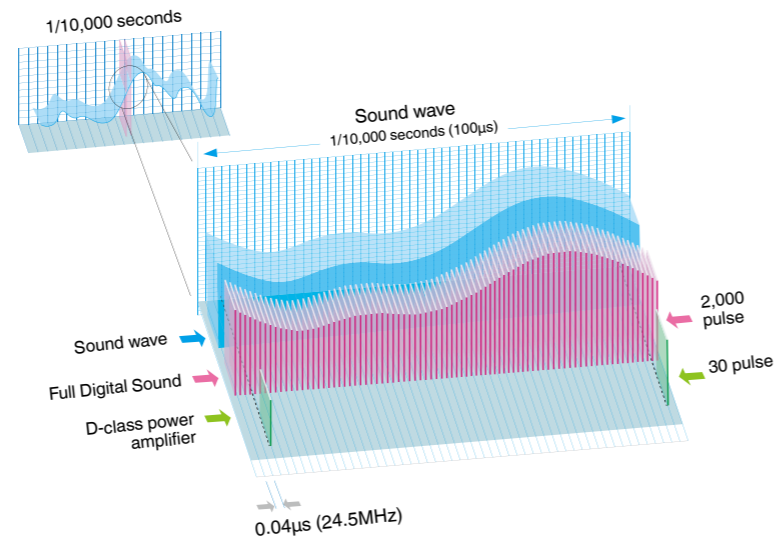

Multi-Drive System

The dedicated LSI for automotive grade separates the source digital signal into multiple signals, which are used to independently drive an equal number of voice coils. Combining the wave forms enables subtle reproduction of sound expressions.

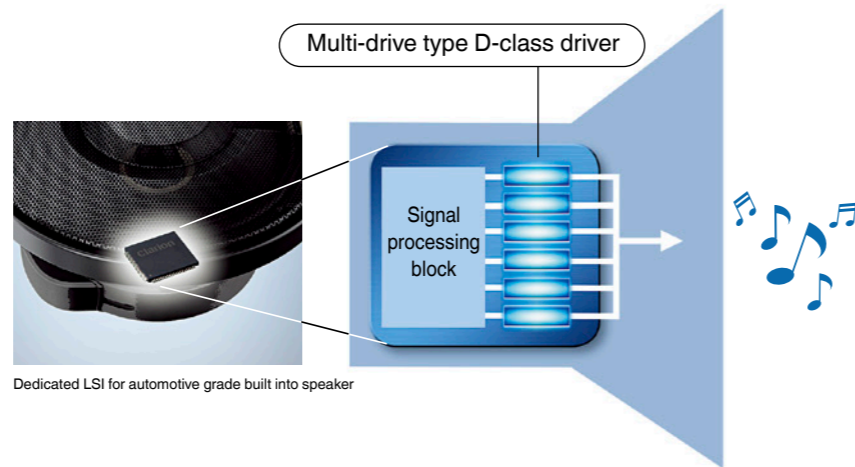

All Speaker Units Driven by Dedicated LSI for Automotive Grade

Each full digital speaker unit offers superior separation because it is driven independently by internal** dedicated LSIs for automotive grade.

**2 The tweeter driver that dedicated LSI for automotive grade is built into the sound processor.

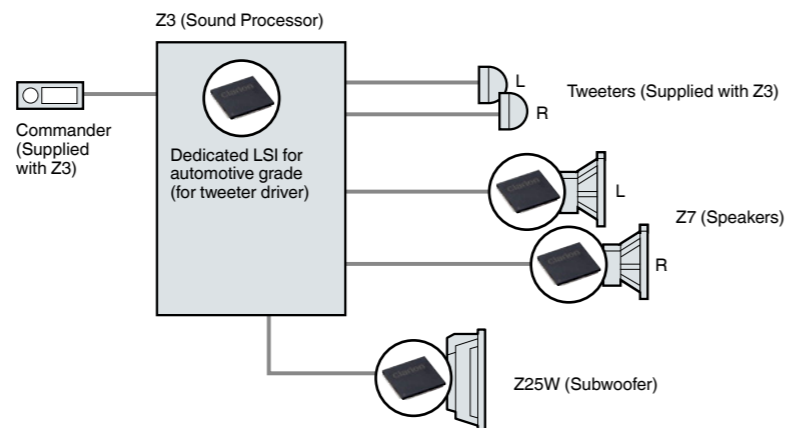

Newly Developed 6-Layer Multi-Voice Coil Goes beyond Conventional Speaker Conceptions

The system incorporates advanced digital signal processing technology (Dnote*) to transmit multiple digital signals directly to the voice coil, as well as a 6-layer multi-voice coil to achieve a precise cone stroke. By consolidating 6 different vibrational forces, the speaker delivers high-powered, high-quality sound even while minimising power consumption to save energy.

Dnote

*3 Trigen Semiconductor's Dnote technology is used for digital signal processing.



1ch
2ch
3ch
4ch
5ch
6ch

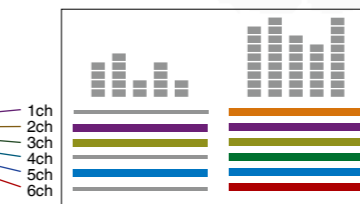

The required voice coils resonate only.

Clarion's proprietary, dedicated LSI for automotive grade converts the 96kHz X 256-times oversampled signal into 6 separate channels of digital signals. Not all of the 6 voice coils are

driven all the time. Only the required voice coils are driven in accordance with the volume level, making for an energy-efficient system.

High-Resolution, High-Response Driving Delivers Sharp, Crisp Sound

The Full Digital Sound system makes extremely high-response reproduction possible by applying only the necessary voltage to the necessary voice coil.

● Conventional analogue speaker

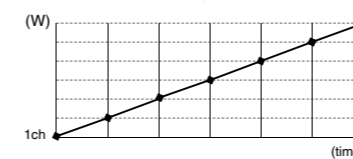

● Full digital speaker

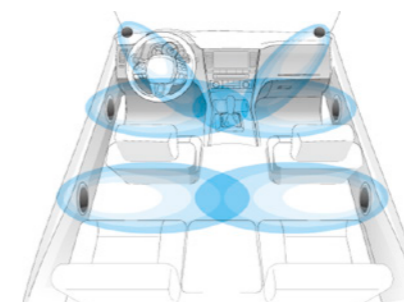
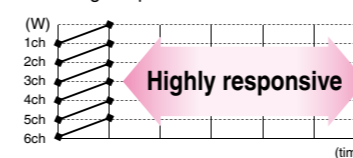

High-response contributes to sound reproduction with clearly defined sound staging.

Clarion's Original High-Purity Transmission and Energy Saving Technologies Take Full Digital Sound to the Next Generation

96kHz Sampling Frequency for High Quality from Sources Ranging from High-Resolution to Analogue

For direct full digital reproduction of high-resolution audio files stored on your high-resolution smartphone (Android™) or tablet, connect using the USB host cable (OTG cable). Other types of digital sources such as CDs will be upconverted to 96kHz/24bit. Analogue sources will be converted to high-resolution digital audio data. Everything from audio processing to the digital transmission of signals to the speakers takes place at high-resolution 96kHz/24bit.

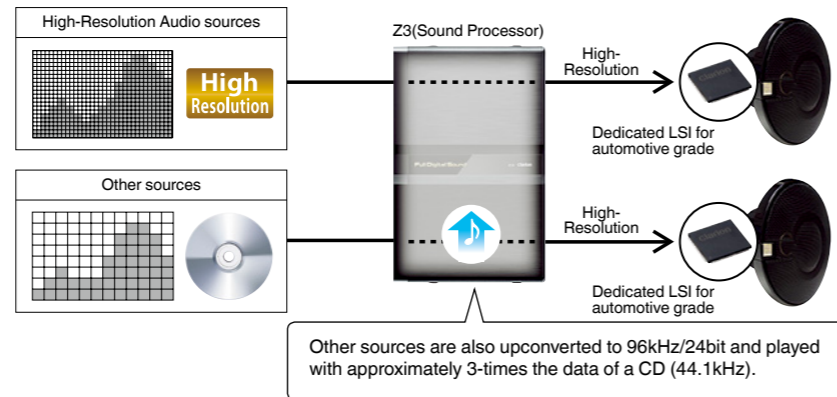

Employs SHARC® High-Precision DSP

32-bit floating point processing enables the DSP to FIR filter to achieve a very accurate Equaliser.



Eliminates the Effects of Counter Electromotive Force for Non-NFB High-Quality Sound

Typical power amplifiers incorporate an NFB (Negative Feedback) circuit in order to attenuate the effects of power fluctuation, minimise distortion, and improve the damping factor to provide stable performance.

However, this method can disrupt the audio waveform by introducing the counter electromotive force generated at the speaker into the input signal, thereby negatively impacting the subtle nuances of sound. Full Digital Sound assures high sound quality by incorporating a high-speed, response-regulated power supply that eliminates those adverse effects.

Digital Signal Transmission Reduces Alternator Noise

The Full Digital Sound system incorporates a high-speed, response-regulated power supply as well as single-point grounding in order to eliminate the ground loop and dramatically reduce the alternator noise that had been a major challenge for conventional audio systems. Doing this has enabled the creation of an exceptional listening environment.

Can now hear even the subtlest sounds that used to be drowned out by noise.

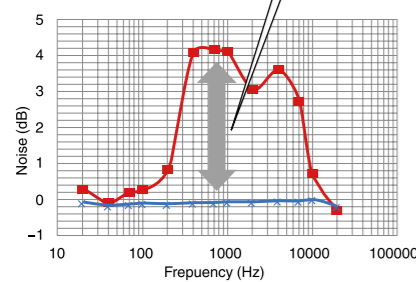

Conventional system

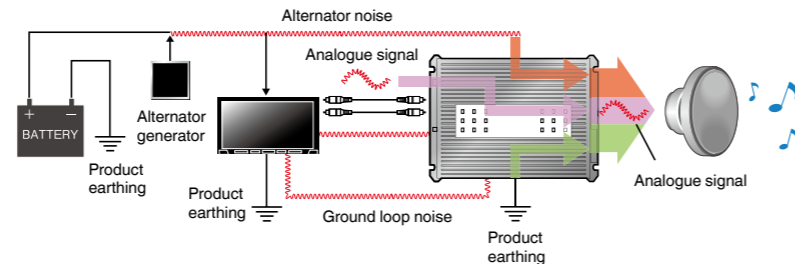

Full Digital Sound system

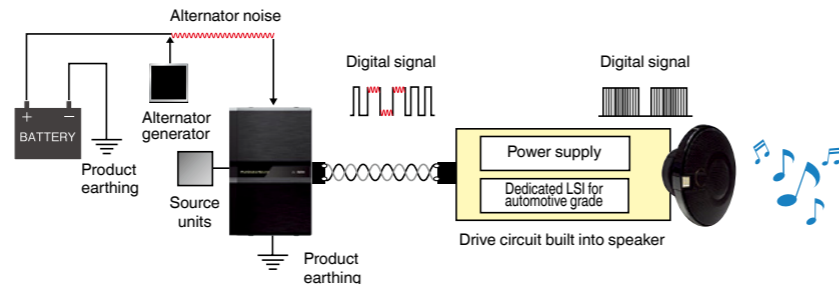

Full Digital Sound for High-Efficiency and Energy Saving

Power Amplifier-Less Design Using Original Driving Method

Unlike conventional systems that require either a power amplifier inside the centre unit or an external power amplifier, our full digital system does not require any power amplifier, enabling the development of lightweight, simplified systems.

Conventional system

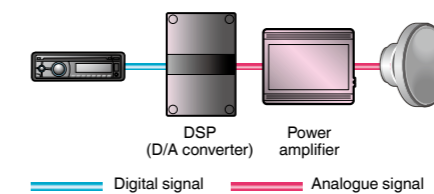

Full Digital Sound system

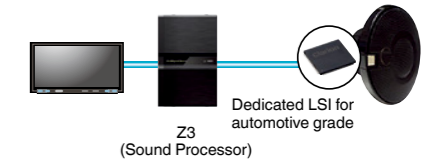

Energy Saving, Compact Design

Electricity is efficiently converted into the power necessary to drive the speakers and output sound. This greatly reduces the energy that until now had been inefficiently wasted as heat. What's more, low output level efficiency is improved compared to common digital power amplifiers. This makes it possible to dramatically improve energy efficiency and create systems without heat sinks, contributing to further miniaturisation and weight reduction.

Comparing power consumption



Made to Resist Power Fluctuations

The Full Digital Sound system is able to accommodate sudden fluctuations of sound pressure because each speaker has its own high-speed, response-regulated power supply.

As a result, system stability is always maintained without having to rely on an external capacitor.

The Versatility of Full Digital Sound

Power Digital Line Carrier System for Easy System Creation through to the Subwoofer

Power and digital signals are transmitted together using the speaker harness of your car as-is. This is the world's first* highly reliable system to piggyback a digital signal at low amplitude in order to maintain compliance with vehicular standards regulating unwanted radiation emissions.

Digital transmission, impervious to the effects of noise, delivers the ultimate quality that even high-grade analogue cables aren't able to provide. What's more, the system is easily scalable and upgradable since no complicated wiring is necessary; connection requires only two cables*2.

*1 As of September 2012 (Clarion research)
*2 Subwoofer requires separate power source connection.

Creating a Clear Sound Worthy of the New Era



Z3 (Sound Processor)

Tweeter (Supplied with Z3)

Commander (Supplied with Z3)

Full Digital Sound Processor

Z3 (Sound Processor / Tweeter / Commander)



Intelligent Tune

Sound Processor

- New dedicated LSI for automotive grade Clarion originally developed (for tweeter driver)
- 96kHz/24bit digital signal processing
- Tuning functions (Crossover, Time Alignment, Equaliser)

Tweeter (Supplied with Z3)

- Dual-voice coil

- Intelligent Tune (Sound Restorer / Virtual Bass / Tone Filter / Reverb Control)
- Input connectors: USB, Digital input (Optical), Digital input (Coaxial), RCA input, Speaker level input
- Output connectors: Output for digital speakers, RCA output

Commander (Supplied with Z3)

Sound Processor

Clear Sound Staging from Sturdy and Sophisticated Cabinet Design

Cool and Minimalistic Body Textured with Hairline Finish



The black matte body features a hairline finish, plus clear material used in the centre. It accentuates the cool look that is befitting of full digital sound.

USB Slot for Direct Input from Mobile Devices and High-Resolution Sources

The Z3 (Sound Processor) is equipped with a USB port for connection to a smartphone or tablet via USB cable. It is easy to use mobile devices. For example, you can play high-resolution audio content stored on a smartphone (Android™), or tune it using a tablet.

*Notes: Does not support audio play from USB memory. The tuning application supports iOS® and Android™.

Compact Sound Processor Installable Just About Anywhere

The compact chassis requires minimal utility space for easy installation under the seat and other tight locations.

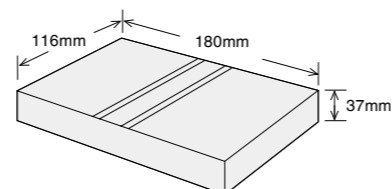

Intuitive Interface for Fine Adjustment of Delicate Sounds

Commander

Large Volume Knob Like Home Audio Systems



The large volume knob offers the solid feel of a high-performance home audio system, and provides superior usability and smooth, intuitive control of volume and the other features. The body's black colour and hairline finish contribute to the solid, quality-intensive form. What's more, the contrast between the metallic texture of the volume knob and the hairline finished body orchestrates a stylish look that you'll never get tired of.

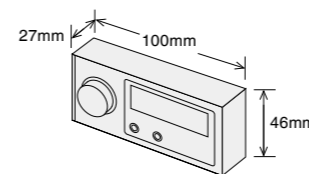

Select the Acoustic Technology You Like

Sound Restorer enables high-quality reproduction of compressed audio, and Reverb Control helps to create a more natural surround sound experience. You can select advanced acoustic technologies like these according to the musical genre or media you are playing.



Rotate the volume knob

Menu display

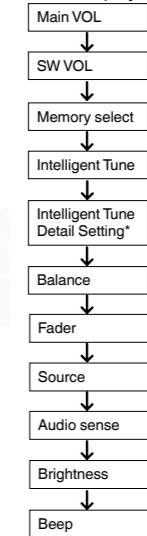

Acoustic technologies selectable according to media or song

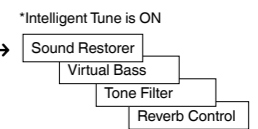

Can select sources such as centre unit or USB (smartphone)

Tweeter

Clear and Dynamic Middle - High Range Reproduction

Beautifully Curved Design Expressing Subtle Tonality



Accented with a champagne gold line, the design taste matches up perfectly with the speaker units.

Pure Soft Dome Tweeter for Rich Middle - High Range

Reproduction of crystal clear highs up to 40kHz and powerful vocals is made possible by this broad bandwidth tweeter. Combining it with the Z7 (speaker) in the front enables high-range reproduction of high-resolution audio sources. In addition to reproducing a lustrous high-range for richly resonating tones, it delivers a powerful mid-range full of presence as well as natural sounding vocals.



2-Way Mountable for Installation on Dashboard or Door

The tweeter can be surface-mounted on the dashboard, or flush-mounted in the door by modifying the door trim.

● Surface-mounting



● Flush-mounting



Reproducing the Full Potential and Appeal of Full Digital Sound



Full Digital Speaker

Z7



- New dedicated LSI for automotive grade Clarion originally developed
- 6-layer multi-voice coil

Classic Black and Champagne Gold Set the Stage for Full Digital Sound



Classic black provides a dignified air, while champagne gold accentuates it with flair. The premium design stimulates pride of ownership, with a sense of power oozing from its stately looks.

Premium Badge to Spice Up your Space



The Z7 comes supplied with a premium Full Digital Sound badge that can be affixed anywhere in your car. Place it on the grille area of the installed speakers to show off your premium system.

● Z7 structure diagram



Multi Power Supply Voice Coil Provides High-Quality Sound and Low Power Consumption

The multi power supply voice coil structure combines driving forces to increase responsiveness, reduce voltage and power consumption, and make a new level of high-power reproduction possible.



ACMI-PP Cone Accurately Accommodates Digital Sources

This hybrid PP cone features high-strength aramid fibres mixed with carbon and mica, and injection-moulded into optimum form. Taking advantage of the various characteristics of each type of fibre, this new material affords superior light weight and high rigidity, for reasonable internal loss enabling precision reproduction of digital signals.



Phase plug Improves the Directivity of Vocals

The phase plug moderates soundwave characteristics and enhances performance and directivity of the mid-range, thereby reproducing clear, lively vocals. Count on it to deliver immersive sound directly to the listener.



Large-diameter Strontium Magnet Supports the High-response Bass Line

The speakers incorporate a Strontium magnet that maintains higher magnetic coercivity than ordinary magnets. In combination with efficient magnetic flux circuitry, they are capable of reproducing highly responsive and dynamic bass sounds.

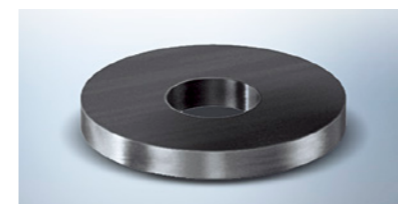

BASSLIZER Enables Reproduction of a Clear and Undistorted Low Range

The middle of each speaker cone is equipped with a reinforcement ring called the BASSLIZER to provide superior rigidity. Since this structure inhibits cone distortion, the speaker is able to resonate with superior linearity even at high volume levels. It reproduces low frequencies with high responsiveness, high clarity and low distortion.

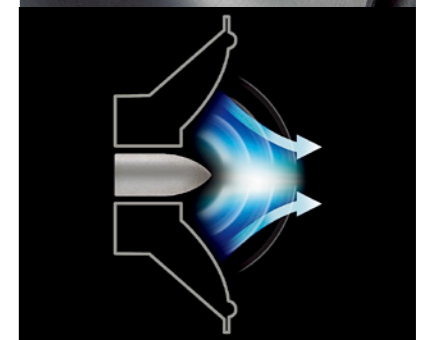

The phase plug optimizes the sound waves from the core of the speaker to achieve clear, transparent sound.

Deep Bass Powerfully Reproduces the Resonance of the Source



Full Digital Subwoofer

Z25W



- New dedicated LSI for automotive grade Clarion originally developed
- 6-layer multi-voice coil

Spin-Finished Centre Cap for a Solid Feel



Champagne gold is used as an accent, as it is for the speaker and tweeter, and the overall matte black finish expresses the deep bass that resonates from the subwoofer. The centre cap has a built-in metal weight ring that contributes to the clear and tight reproduction of the low frequency range. Optimal weight balance makes for consistent bass performance.

Thin Profile Design with Built-in Drive Circuit

Dedicated LSI for automotive grade Clarion originally developed is built into the drive circuit, which is incorporated into a thin-profile design that fits the woofer magnetic circuit within the frame. So while being extremely powerful, it maintains a compact size that does not overuse the car's utility space.



Drive circuit

GAC-Composite Cone Delivers Powerful Sound by Capitalising on the Characteristics of Each Fibre

Clarion developed the new GAC-Composite cone by combining GAC (Glass/Aramid/Carbon) fibres in a lightweight and rigid pulp base material. Taking advantage of the various characteristics of each type of fibre, the new semi-oven cone affords high rigidity and optimal internal loss for reproduction of tight and powerful bass.



Specifications

Sound processor

Analogue output	4Vrms (VOL 0dB)
S/N	110dB (A filter)
Harmonic Distortion	0.01%
Analogue input	RCA input, Speaker level input
Input sensitivity	Low: RCA-in=4Vrms/power-in=8Vrms
	Mid: RCA-in=2Vrms/power-in=4Vrms
	High: RCA-in=1Vrms/power-in=2Vrms
Digital coaxial input	0.5Vp-p/75Ω, Up to 96kHz/24Bit/PCM
Digital optical input	Up to 96kHz/24Bit/PCM
Power Supply	10.8 ~ 15.6V DC, Negative ground
Current Consumption	Maximum 15A
Weight	660g
Dimensions	180(W)×37(H)×116(D)mm

Z7 (Full Digital Speaker)

< Driving section >

Maximum output	24W (4W × 6 Driver)
Rated output	18W (3W × 6 Driver) at 1% THD+N
S/N	89dB at 1W
Dynamic range	102dB
Frequency response	10Hz ~ 48kHz ± 2dB

< Speaker section >

Impedance	4Ω × 6ch
Frequency response	28Hz ~ 15kHz
Fs	60Hz
Qts	0.85
Vas	11.4Liters
Weight (One speaker)	970g
Dimensions	158(W)×158(H)×76(D)mm

Commander (Supplied with Z3)

Weight	385g
Dimensions	100(W)×27(H)×46(D)mm

Tweeter (Supplied with Z3)

< Driving section >

Maximum output	9W (4.5W × 2 Driver) × 2ch
Rated output	6W (3W × 2 Driver) × 2ch at 1% THD+N

< Speaker section >

Impedance	6Ω × 2ch
Frequency response	1.5kHz ~ 40kHz
Weight (One speaker)	77g
Dimensions	40(W)×40(H)×21.5(D)mm

Z25W (Full Digital Subwoofer)

< Driving section >

Maximum output	24W (4W × 6 Driver)
Rated output	18W (3W × 6 Driver) at 1% THD+N
S/N	90dB at 1W
Dynamic range	103dB
Frequency response	10Hz ~ 48kHz ± 2dB

< Speaker section >

Impedance	4Ω × 6ch
Frequency response	20Hz ~ 200Hz
Fs	38Hz
Vas	50.3Liters
Mms	74.4g
Qes	0.74
Qms	4.75
Qts	0.64
Xmax.Lin.	11.4mm
Weight	3,820g
Dimensions	296(W)×296(H)×98.5(D)mm
Recommended box volume	Shielded box: 25Liters ~ 45Liters
	Ported box: 85Liters ~ 95Liters

Commander (Supplied with Z3) Operation command list

Settings		Adjustment method		
		Commander	Tuning application	
Main VOL	-99dB ~ 0dB (1dB step)	○	—	
SW VOL	-10dB ~ +10dB (0.5dB step)	○	—	
Memory select	Custom memory 1 / Custom memory 2 / Custom memory 3 / Custom memory 4 (4 Patterns)	○	○	
Intelligent Tune	Sound Restorer	OFF / Low / Mid / High	○	○
	Virtual Bass	OFF / Low / Mid / High	○	○
	Tone Filter	Vivid +2 / Vivid +1 / OFF / Vintage +1 / Vintage +2	○	○
	Reverb Control	OFF / Low / Mid / High	○	○
Balance	Left 12 ~ Centre ~ Right 12	○	—	
Fader	Rear 12 ~ Centre ~ Front 12	○	—	
Source (Input setting)	Digital optical / Digital coaxial / Analogue / USB	○	—	
Audio sense	Low / Mid / High	○	—	
Brightness	OFF / Level 1 ~ 10	○	—	
Beep	ON / OFF	○	—	

Main supplied items

Z3

- Sound Processor
- Commander (2.46m)
- Tweeter kit
- Power cable (2.5m) *
* Grounding cord (2m)
- Speaker input cable (2m)
- USB cable A (0.5m)
- USB cable B (0.15m)

< Tweeter kit >

- Tweeter × 2
- Mount adapter × 2
- Flush-mount spacer × 2
- Lever arm × 2
- Z3 output cord (0.3m)
- Extension cord (3m) × 2

Z7

- Full Digital Speaker (R)
- Full Digital Speaker (L)
- Grille × 2
- Punching net × 2
- Premium badge × 2
- Z3 output cord (2m)

Z25W

- Full Digital Subwoofer
- Z3 output / power cord *
* Z3 output cord (5m)
* Main power cord (5m)
* Grounding cord (3.5m)

This is the Era of Choosing System Upgrades

Today, it is easier than ever to enjoy sound just the way you like, thanks to smartphones, other high-quality devices and media that can play high-resolution audio. That is why users demand more flexibility and options in their sound system interfaces. Full Digital Sound was developed to meet the needs of this new age of digital audio. The Full Digital Sound processor and speakers are not only compatible with centre units that offer digital output; they also produce high-quality sound from smartphones connected to the centre unit, and are even compatible with some analogue devices, such as power amplifiers, analogue speakers, and subwoofers. If you are upgrading your system, Full Digital Sound gives you a ton of options.

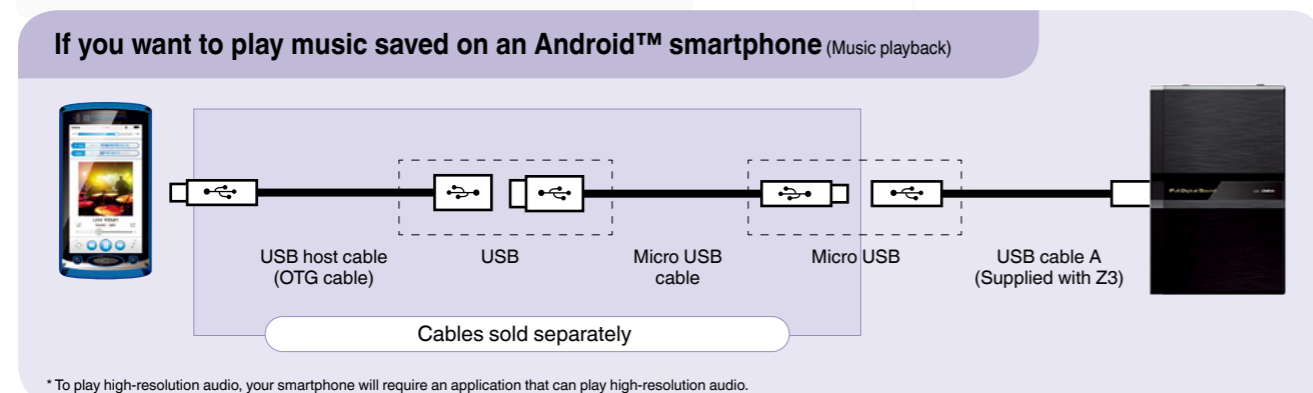
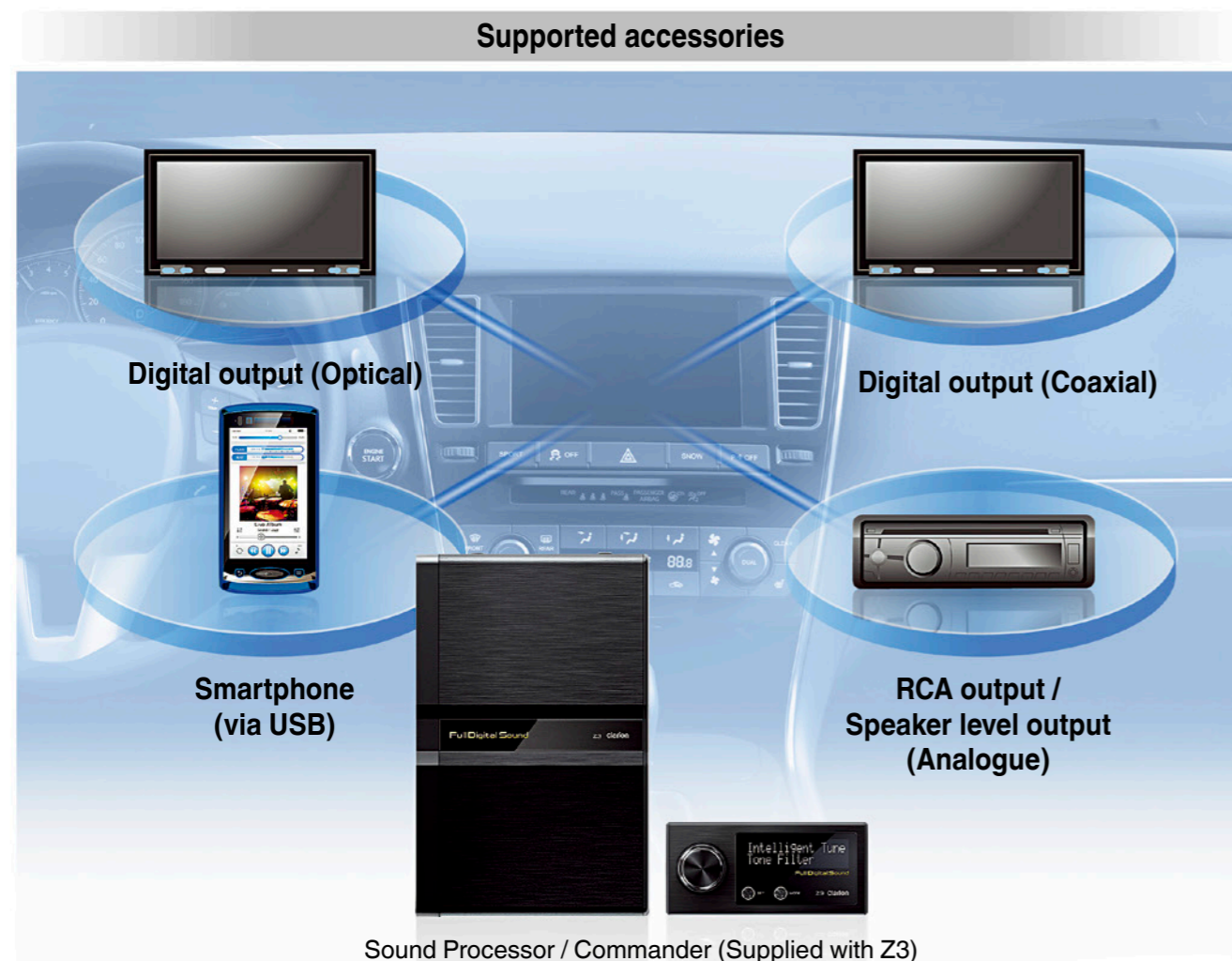

Full system

If you want to fully experience high-quality digital sound

Z3 + Z7 + Z7 + Z25W + Z25W

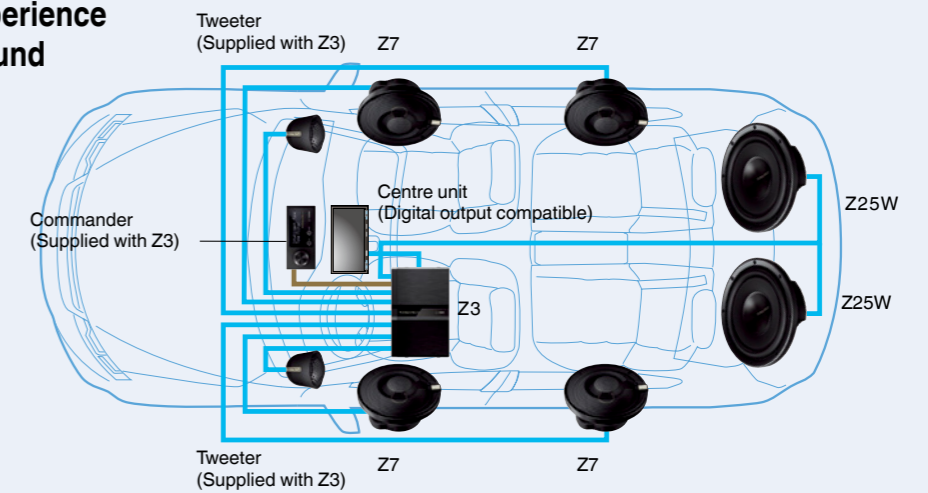

Simple system

If you want to casually enjoy high-quality digital sound

Z3 + Z7 + Z25W

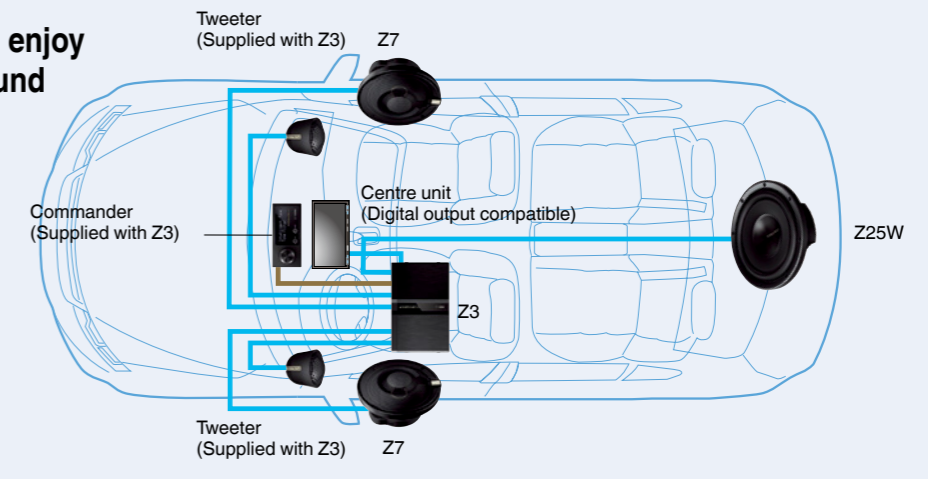

Digital + Analogue mixed system

If you want to make use of existing analogue devices

Z3 + Z7 + Power amplifier + Analogue rear speaker/ Analogue subwoofer

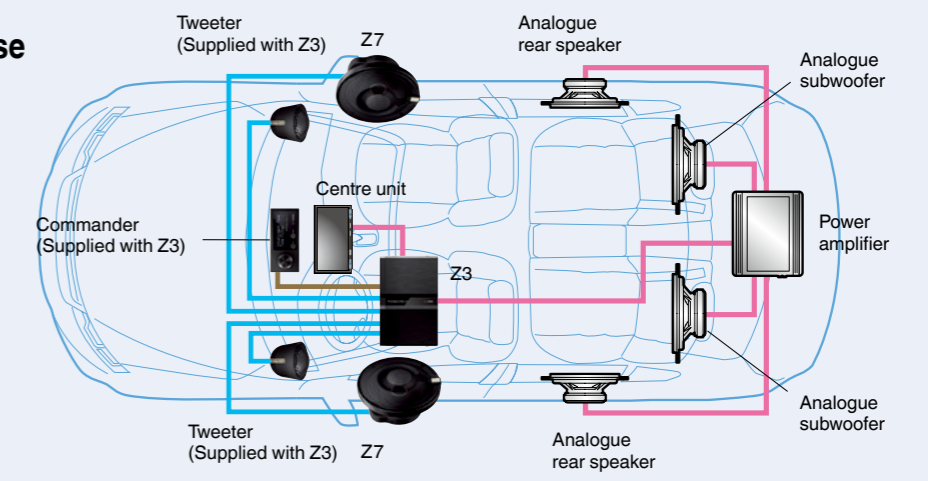

* RCA output to power amplifier limited to 2 channels.
* Speaker output may vary with power amplifier.

Intuitive Touch-Based Tuning via Smartphones and Tablets

Clarion's new application offers an easy way to tune your car's audio with a tablet or smartphone. Unlike conventional PC-based tuning software offered in the past, this application provides an intuitive, touch-based interface that makes it easy to fine-tune your sound with a high degree of accuracy.

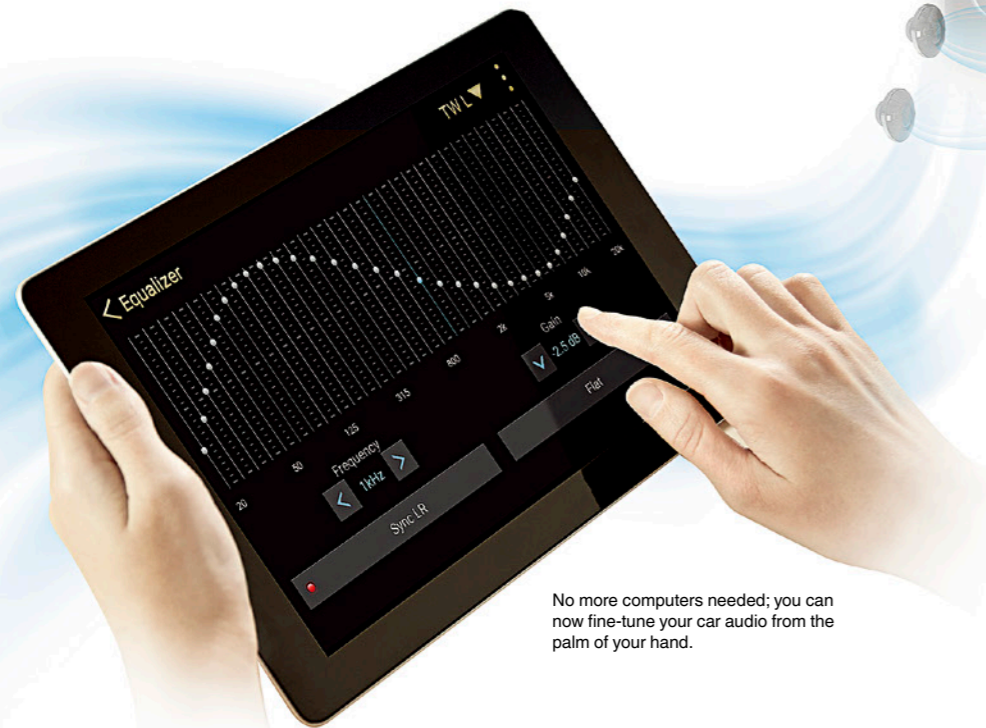

No more computers needed; you can now fine-tune your car audio from the palm of your hand.

Tune the Z3 Full Digital Sound Processor with one application.

<Z-tune> FREE

App Store™ Google Play™ Store

Z-tune offers key tuning features such as Crossover, Time Alignment and Equaliser, all of which can be operated by touch. The application is also compatible with Intelligent Tune, which uses Clarion's proprietary sound technology. Up to 4 tuning setups can be saved, allowing you to switch between them to suit your mood and your music.

- < Main Features >
- Crossover
 - Time Alignment
 - L / R independent 31-band Equaliser
 - Intelligent Tune (Sound Restorer / Virtual Bass / Tone Filter / Reverb Control)

* For more information on systems and device compatibility, visit the Clarion website.

Easy to understand at a single glance

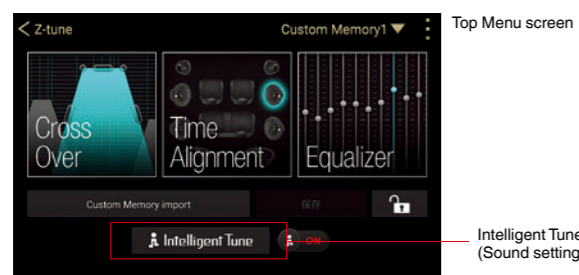

A graphical display makes the information easy to understand with this all-purpose sound setup application.

Easy to download at any time



The application can be downloaded from the App Store™ and the Google Play™ Store. There is no need to bring your laptop with you.

Full Digital Sound
Tuning Application



Intuitive, touch-based tuning



Swipe

< 31-band Equaliser >
Trace with your fingers to create a target curve.



Drag

< Time Alignment >
Drag to set the intervals.

How to access the Z-tune application

1 Download the application

The application can be downloaded from the App Store™ and the Google Play™ Store. There is no need to bring your laptop with you.



2 After downloading, connect your device to the Z3 Sound Processor

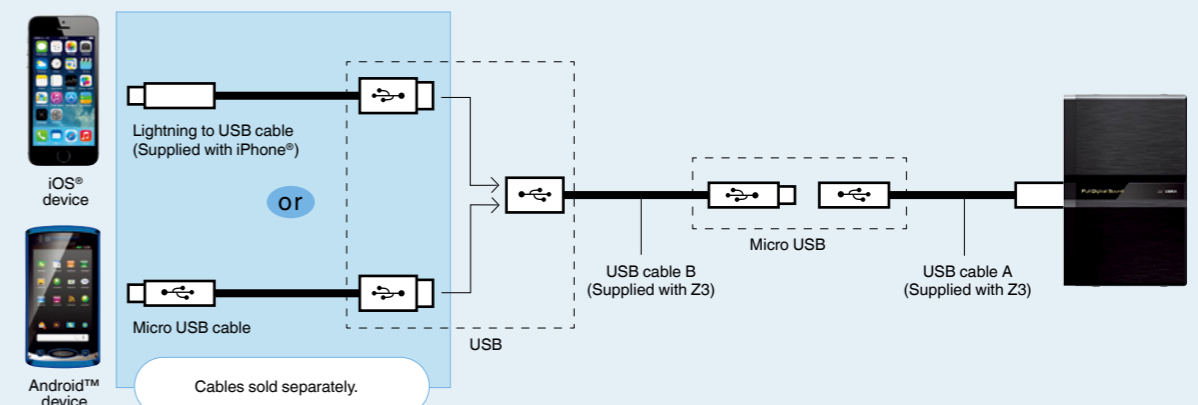

* For more information on systems and device compatibility, visit the Clarion website.

Fine Tuning Your Sound to Create an Ideal Listening Space



Equalise your Onboard Sound to an Unprecedented Level of Detail with L/R Independent 31-band Equaliser

Fine tune each channel using the built-in L/R independent 31-band Equaliser, which is equipped with a linear-phase FIR filter that removes phase distortion. Clarion's proprietary sound technology greatly reduces interference between bandwidths, allowing for intuitive sound equalisation that produces the exact balance you're looking for.



Double tap to zoom in for more precise fine-tuning



Localize your Sound with Ease and with Pinpoint Accuracy Using Time Alignment

Each channel can be fine-tuned to 0.7 cm per step. A dedicated application offers a touch-based interface for localizing your sound simply, and with pinpoint accuracy.

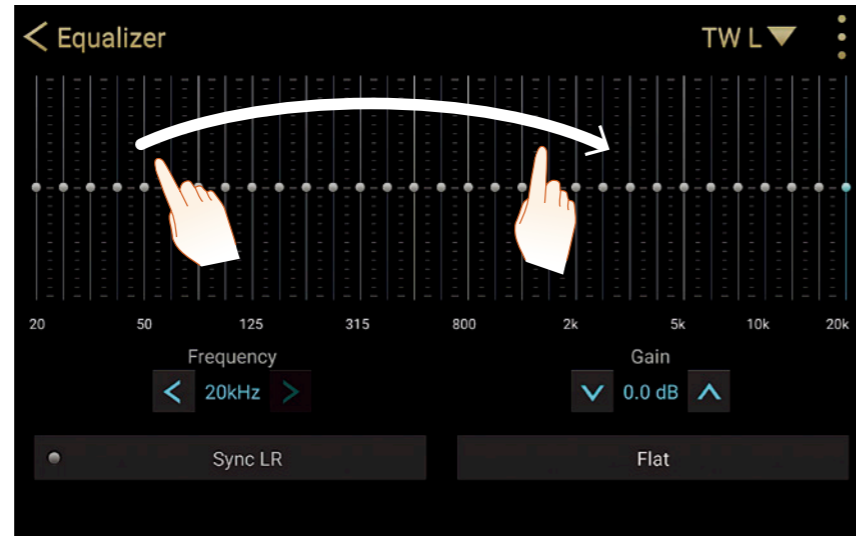

Trace the screen during 31-band display to initialize the equaliser plot.

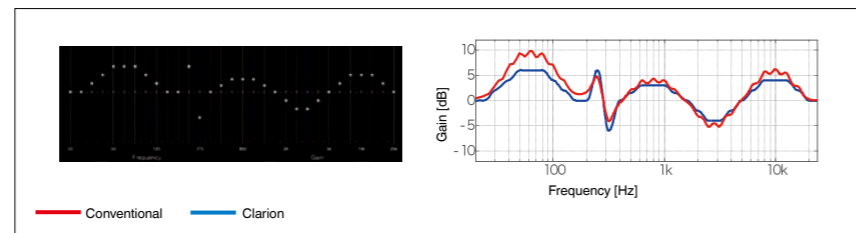

Get the exact frequency properties that you set up on the screen

< Equaliser specification >

Tweeter L/R, Front speaker L/R Rear speaker L/R, Subwoofer L/R Up to 8 channels can be independently set.	31-band Equaliser Frequency : 20Hz ~ 20kHz (1/3oct step) Gain : -12dB ~ +12dB (0.5dB step) FIR filter configuration
---	--

< Time Alignment specification >

Tweeter L/R, Front speaker L/R Rear speaker L/R, Subwoofer L/R Up to 8 channels can be independently tuned.	Delay adjustment: 0cm ~ 525cm (0.7cm step)
Mute	8 individual channels mute ON / OFF setting

Draw out the Maximum Potential of each Unit with Crossover

Create an optimal crossover setup that best complements the system design and each speaker's properties. A graphical setup screen combines touch and button-based interfaces to offer an intuitive and high-quality setup experience.

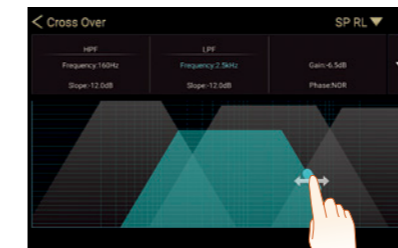
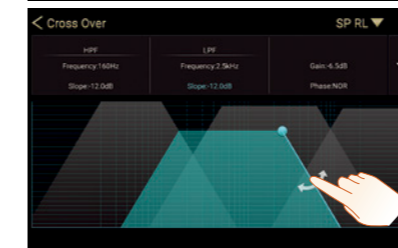
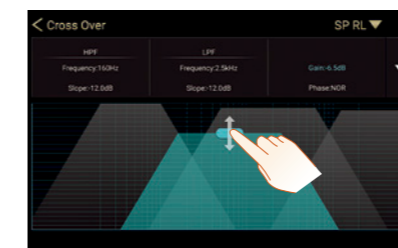

Set up everything simply by tapping and dragging.

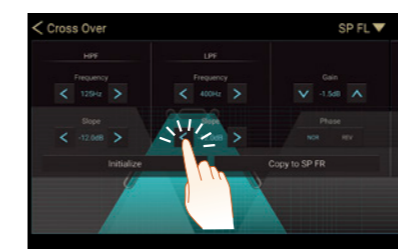

Adjustment of numerical values enables subtle control.

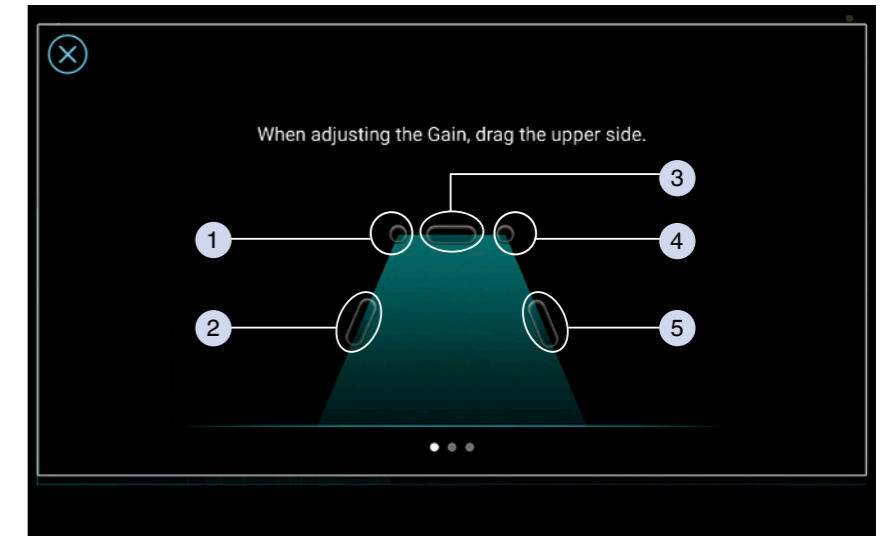

Tap the point you want to set and adjust each item.

- 1 HPF slope
- 2 HPF frequency
- 3 Gain
- 4 LPF slope
- 5 LPF frequency

< Crossover specification >

Tweeter L/R (Digital signal)	HPF frequency : 315Hz ~ 16kHz (1/3oct step) Slope : -72dB/oct ~ 0dB/oct (6dB step) Gain : -24dB ~ 0dB (0.5dB step) Phase : NOR/REV
Front speaker L/R (Digital signal)	LPF frequency : 250Hz ~ 16kHz (1/3oct step) Slope : -72dB/oct ~ 0dB/oct (6dB step) Gain : -24dB ~ 0dB (0.5dB step) Phase : NOR/REV HPF frequency : 25Hz ~ 10kHz (1/3oct step) Slope : -72dB/oct ~ 0dB/oct (6dB step) Gain : -24dB ~ 0dB (0.5dB step) Phase : NOR/REV
Rear speaker L/R (Digital signal/Analogue signal)	LPF frequency : 250Hz ~ 16kHz (1/3oct step) Slope : -72dB/oct ~ 0dB/oct (6dB step) Gain : -24dB ~ 0dB (0.5dB step) Phase : NOR/REV HPF frequency : 25Hz ~ 10kHz (1/3oct step) Slope : -72dB/oct ~ 0dB/oct (6dB step) Gain : -24dB ~ 0dB (0.5dB step) Phase : NOR/REV
Subwoofer L/R (Digital signal/Analogue signal)	LPF frequency : 25Hz ~ 250Hz (1/3oct step) Slope : -72dB/oct ~ 0dB/oct (6dB step) Gain : -24dB ~ 0dB (0.5dB step) Phase : NOR/REV HPF frequency : 20Hz ~ 80Hz (1/3oct step) Slope : -72dB/oct ~ 0dB/oct (6dB step) Gain : -24dB ~ 0dB (0.5dB step) Phase : NOR/REV

Drawing out the Best of Full Digital Sound with Intelligent Tune, Clarion's Proprietary Sound Technology

Intelligent Tune was developed by Clarion to achieve the best sound possible in a car. It comes packed with a variety of features that reflect Clarion's history of the continuous pursuit of ever better sounds.

Full Digital Sound

Sound Technology



The Commander (Supplied with Z3) can be used to control Intelligent Tune, sound volume, and other features. The volume knob makes it easy to set, like a high-quality home audio system.

Virtual Bass Reproduces Dynamic Sound Full of Powerful Lows

Using the psychology of sound perception, Clarion added overtones to enhance deep and low frequency sounds that cannot be reproduced with speakers alone. Even small speakers will produce a deep bass sound as if they were connected to a subwoofer.

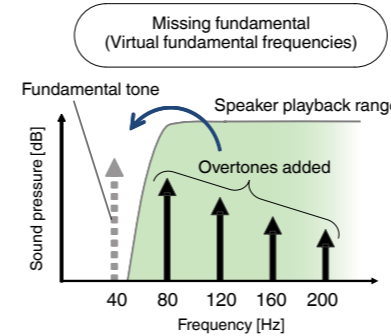

Converting Compressed Audio Source into High-Quality Sound with Sound Restorer

High-frequency signals that are lost in CDs and when compressing sound into digital formats such as MP3 and AAC are reconstructed so that the sound is restored to almost its original form. Sound Restorer also expands the range to high-resolution levels to recreate the pure expression of the sound.

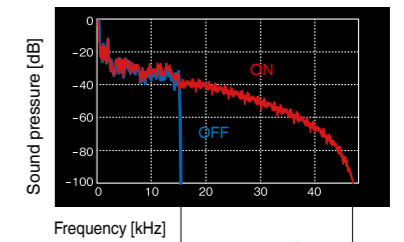
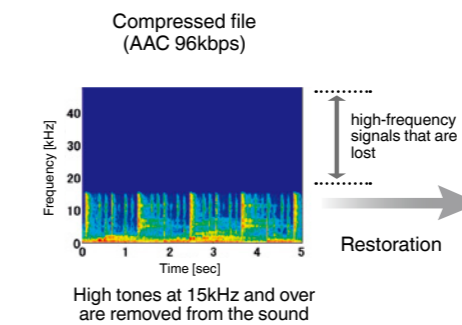

CD sound is also expanded to high-resolution levels

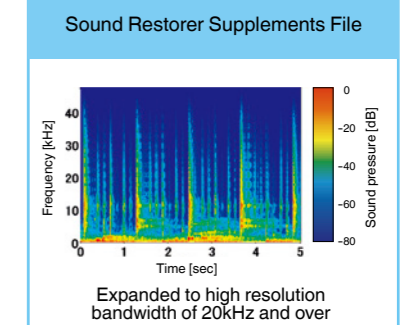

A new sound technology that processes signals by bandwidth

NEW

Create the Sound You Want with Tone Filter

Tone Filter allows you to control the aggressive sounds and reverb of instruments to produce a richer, more expressive sound. Vintage Mode lets you produce a deep, warm sound with valve amp emulation, while Vivid Mode creates a more colourful sound that emphasizes the beat.



NEW

Produce a Rich, Natural Surround Sound with Reverberant Sound Control

Reverb, which gives the sound its personality, is controlled using state-of-the-art reverb separation to create a surround sound effect. Experience the dynamism and immediacy of a music venue in the comfort of your car.

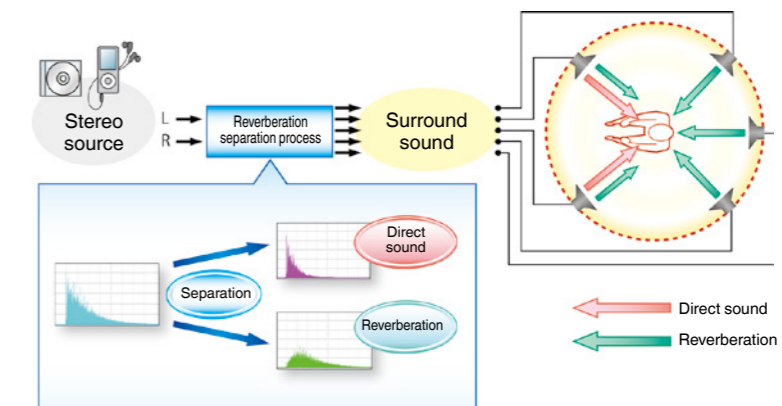

You can set it using the Commander (Supplied with Z3) or the Z-tune application

Intelligent Tune can be set with the Commander, which is supplied with Z3, or with the Z-tune application, which can be downloaded to a smartphone or tablet.



Setting with the Commander

The display's excellent readability makes it easy to see information during the day or at night.

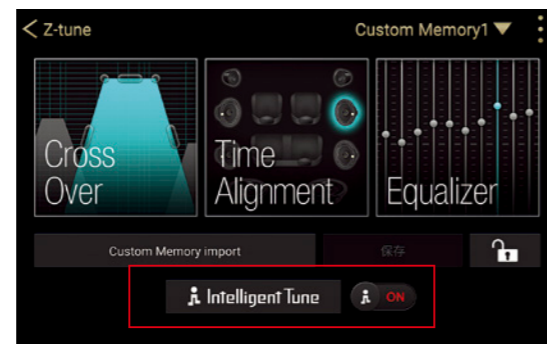

Setting with a tablet or smartphone

Settings can be made using an intuitive touch-based interface.